

Emerging Dairy Processing Technologies

Opportunities for the Dairy Industry

Edited by
Nivedita Datta and Peggy M. Tomasula



Emerging Dairy Processing Technologies

Emerging Dairy Processing Technologies

Opportunities for the Dairy Industry

Edited by

Nivedita Datta

*College of Health and Biomedicine, Victoria University, Melbourne,
Victoria, Australia*

Peggy M. Tomasula

*Dairy and Functional Foods Research Unit, United States Department of
Agriculture, Agricultural Research Service, Eastern Regional Research
Center, Wyndmoor, PA, USA*

WILEY Blackwell

This edition first published 2015 ©2015 by John Wiley & Sons, Ltd

Registered office: John Wiley & Sons, Ltd, The Atrium, Southern Gate, Chichester, West Sussex, PO19 8SQ, UK

Editorial offices: 9600 Garsington Road, Oxford, OX4 2DQ, UK
The Atrium, Southern Gate, Chichester, West Sussex, PO19 8SQ, UK
111 River Street, Hoboken, NJ 07030-5774, USA

For details of our global editorial offices, for customer services and for information about how to apply for permission to reuse the copyright material in this book please see our website at www.wiley.com/wiley-blackwell.

The right of the author to be identified as the author of this work has been asserted in accordance with the UK Copyright, Designs and Patents Act 1988.

All rights reserved. No part of this publication may be reproduced, stored in a retrieval system, or transmitted, in any form or by any means, electronic, mechanical, photocopying, recording or otherwise, except as permitted by the UK Copyright, Designs and Patents Act 1988, without the prior permission of the publisher.

Designations used by companies to distinguish their products are often claimed as trademarks. All brand names and product names used in this book are trade names, service marks, trademarks or registered trademarks of their respective owners. The publisher is not associated with any product or vendor mentioned in this book.

Limit of Liability/Disclaimer of Warranty: While the publisher and author(s) have used their best efforts in preparing this book, they make no representations or warranties with respect to the accuracy or completeness of the contents of this book and specifically disclaim any implied warranties of merchantability or fitness for a particular purpose. It is sold on the understanding that the publisher is not engaged in rendering professional services and neither the publisher nor the author shall be liable for damages arising herefrom. If professional advice or other expert assistance is required, the services of a competent professional should be sought.

Library of Congress Cataloging-in-Publication Data

Emerging dairy processing technologies : opportunities for the dairy industry / edited by Nivedita Datta, Peggy M. Tomasula.

pages cm

Includes bibliographical references and index.

ISBN 978-1-118-56062-4 (cloth)

1. Dairy products industry--Technological innovations.
2. Dairy processing.
3. Pasteurization.
4. Milk--Pasteurization. I. Datta, Nivedita, editor. II. Tomasula, Peggy M., editor. SF250.5.E44 2015 637--dc23

2014050138

A catalogue record for this book is available from the British Library.

Wiley also publishes its books in a variety of electronic formats. Some content that appears in print may not be available in electronic books.

Cover image: Cheese blocks © iStock.com/urbancow; Sheep's Milk Cheese © iStock.com/alexandrumagurean; Milk Bottling © iStock.com/Jason Lugo

Set in 9.5/11.5pt TimesTenLTstd-Roman by Laserwords Private Limited, Chennai, India.

Contents

About the IFST Advances in Food Science Book Series	xi
List of Contributors	xiii
Preface	xv
1 Crossflow Microfiltration in the Dairy Industry	1
<i>Peggy M. Tomasula and Laetitia M. Bonnaille</i>	
1.1 Introduction	1
1.1.1 Membrane Types	1
1.1.2 MF Membranes	3
1.1.3 Pilot Plant Testing	6
1.2 MF Principles and Models	8
1.2.1 Gel Polarization Models	10
1.2.2 Osmotic Pressure Model	11
1.2.3 Resistance-in-Series Model	12
1.3 Applications of MF	13
1.3.1 Production of Concentrated Micellar Casein and Whey Proteins	13
1.3.2 Extended Shelf Life Milk	15
1.3.3 Cold Processing MF of Milk	20
1.3.4 Separation and Fractionation of Milk Fat from Whole Milk or Buttermilk	21
1.3.5 Separation of Milk Bioactive Compounds	22
1.3.6 Other Applications	23
1.4 Membrane Modifications to Increase Performance	23
1.5 Microsieves	23
1.6 Conclusions	24
Acknowledgements	25
Disclaimer	25
References	25
2 Novel Thermal Methods in Dairy Processing	33
<i>Vijay K. Mishra and Lata Ramchandran</i>	
2.1 Introduction	33
2.2 Ohmic Heating	36
2.2.1 Principles	37
2.2.2 Factors Affecting OH	37
2.2.3 Applications and Influence of OH on Dairy Product Quality	40

2.3	Microwave Heating (MWH) and Radio Frequency Heating (RFH)	42
2.3.1	Principles	43
2.3.2	Factors Affecting MWH and RFH	44
2.3.3	Applications and Influence on Quality of Milk and Milk Products	48
2.4	Aspects of Microbiological Safety of Dairy Products	55
2.5	Conclusions	60
	References	61
3	High-Pressure Processing of Milk and Dairy Products	71
	<i>Daniela D. Voigt, Alan L. Kelly, and Thom Huppertz</i>	
3.1	Introduction to High-Pressure Processing	71
3.2	Effects of High Pressure on Food Constituents: Basic Considerations	74
3.3	Effects of High Pressure on the Constituents of Milk	74
3.3.1	Milk Salts	74
3.3.2	Milk Fat and Milk Fat Globules	75
3.3.3	Whey Proteins	75
3.3.4	Casein Micelles	76
3.3.5	Milk Enzymes	77
3.3.6	Viscosity and Rheological Properties	78
3.4	Effects of High Pressure on Dairy Microbiology	78
3.5	HP Treatment and Cheese	79
3.6	High-Pressure Processing and Yoghurt	83
3.7	High-Pressure Processing and Functional Dairy Products	83
3.8	Ice Cream	84
3.9	Conclusions and Perspectives for the Dairy Industry	85
	References	85
4	Applications of High-Pressure Homogenization and Microfluidization for Milk and Dairy Products	93
	<i>John Tobin, Sinead P. Heffernan, Daniel M. Mulvihill, Thom Huppertz, and Alan L. Kelly</i>	
4.1	Introduction	93
4.2	Emulsion Stability and Instability	94
4.2.1	Effects of Homogenization	94
4.2.2	Principles of High-Pressure Homogenization	96
4.2.3	Microfluidization	98
4.3	Effects of High-Pressure Homogenization and Microfluidization on Milk Constituents	99
4.3.1	Milk Fat Globules	99
4.3.2	Milk Proteins	101
4.3.3	Milk Enzymes	102
4.3.4	Microorganisms	103
4.4	Applications of HPH and Microfluidization in the Manufacture of Dairy Products	103
4.4.1	Milk	103
4.4.2	Yoghurt Manufacture	104
4.4.3	Cheese	105
4.4.4	Ice Cream	106
4.4.5	Cream Liqueurs	107
4.5	Conclusions and Future Perspectives	108
	References	108

5	Pulsed Electric Fields (PEF) Processing of Milk and Dairy Products	115
	<i>Fernando Sampedro and Dolores Rodrigo</i>	
5.1	Introduction	115
5.1.1	Technology Principles	115
5.1.2	Processing Equipment	117
5.2	Application of PEF for Milk Pasteurization	118
5.2.1	Microbiological Aspects	118
5.2.2	Quality Aspects	125
5.2.3	Bioactive Compounds	128
5.2.4	Shelf Life Extension	128
5.3	Application of PEF to Dairy Products	130
5.3.1	Fruit Juice–Milk Beverages	130
5.3.2	Soya Milk and Fruit Juice–Soya Milk Beverages	137
5.3.3	Yogurt-Based Beverages	138
5.3.4	Infant Formula Milk Beverages	138
5.3.5	Other Milk-Based Beverages	139
5.4	Commercial Applications of PEF for Milk Pasteurization	140
5.5	Conclusions	141
	References	141
6	High Power Ultrasound Processing in Milk and Dairy Products	149
	<i>Bogdan Zisu and Jayani Chandrapala</i>	
6.1	Introduction: Ultrasound in Dairy	149
6.2	Ultrasonic Equipment	151
6.3	Effects of Sonication on Milk Fat: Homogenization and Creaming	152
6.3.1	Homogenization	152
6.3.2	Creaming	155
6.4	Degassing and Foam Reduction	155
6.5	Thermosonication to Reduce Microbial Load	156
6.6	Ultrasound Assisted Filtration	157
6.7	Sonocrystallization of Lactose from Whey	159
6.8	Solubility of Rehydrated Powders	161
6.9	Effects of sonication on Milk and Casein Systems	163
6.9.1	Effects of Sonication on the Casein Micelle	163
6.9.2	Applied Ultrasound to Control the Viscosity of Milk Concentrates	164
6.10	Effects of Sonication on the Physical and Functional Properties of Whey Proteins	167
6.10.1	Gelation and Viscosity	167
6.10.2	Understanding Whey Protein Changes Induced by Ultrasound	169
6.10.3	Heat Stability of Whey Proteins	169
6.11	Sensory Characteristics of Sonicated Milk and Whey	172
6.12	Conclusions	173
	References	173
7	Ultraviolet and Pulsed Light Technologies in Dairy Processing	181
	<i>Nivedita Datta, Poornima Harimurugan, and Enzo A. Palombo</i>	
7.1	Introduction	181
7.2	Basic Principles of UV Processing	183
7.2.1	The UV Process	183
7.3	Available UV Treatment Equipment and Their Operation	185

7.3.1	UV Dose Determination	187
7.3.2	UV Dose Measurement	188
7.4	Effects of UV Treatment on Microorganisms	188
7.4.1	Mechanisms of Action	188
7.4.2	Inactivation of Bacteria in Milk and Dairy Products	189
7.4.3	Packaging and Surface Disinfection	192
7.5	Commercial Developments	192
7.6	Other Light Processing Technique using UV light	194
7.7	Basic Principle of PL Technology	195
7.8	Effects of PL on Microorganisms	196
7.8.1	Mechanisms of Action	196
7.8.2	Inactivation of Bacteria in Liquid and Dairy Products	196
7.9	Commercial Developments	199
7.10	Conclusions	199
	Acknowledgements	200
	References	200
8	Carbon Dioxide: An Alternative Processing Method for Milk	205
	<i>Laetitia M. Bonnaille and Peggy M. Tomasula</i>	
8.1	Introduction	205
8.2	Physicochemical Principles	206
8.2.1	Solubility of CO ₂ in Aqueous Solutions	207
8.2.2	Solubility of CO ₂ in Milk	208
8.3	Microbiological Action of High-Pressure and Supercritical CO ₂	209
8.3.1	Mechanism of Action of CO ₂	209
8.3.2	Influence of Processing Parameters: T, P, Agitation and Time	211
8.3.3	Inactivation of Different Microorganisms with CO ₂	211
8.3.4	Kinetics of Bacterial Inactivation with CO ₂	223
8.4	High-Pressure CO ₂ Treatment of Milk and Dairy Foods	223
8.4.1	Microbial Flora of Raw and Pasteurized Milk	223
8.4.2	Food Composition Affects the Bactericidal Action of CO ₂	225
8.4.3	Treatment of Milk with High-Pressure CO ₂	226
8.5	Low-Pressure CO ₂ Injection (Carbonation) to Extend the Shelf Life of Fluid Milk and Soft Dairy Products	228
8.5.1	Advantages of Carbonation	228
8.5.2	Does CO ₂ Treatment Affect the Quality and Functionality of Dairy Products?	229
8.5.3	Carbonated Raw Milk	230
8.5.4	Carbonated Pasteurized Milk	231
8.5.5	Cottage Cheese	232
8.5.6	Yogurt	233
8.5.7	Fermented and Flavoured Dairy Beverages	233
8.5.8	Butter, Sour Cream and Ice Cream	234
8.6	Other Dairy-Related Applications for CO ₂	234
8.6.1	Fractionation of Milk Lipids	234
8.6.2	Manufacture of Cheese from CO ₂ -Treated Milk	236
8.6.3	Fractionation of Milk Proteins	237
8.7	Regulatory Status	239
	Acknowledgements	240
	References	240

9	Non-Thermal Pasteurization of Milk Using CHIEF Technology	251
	<i>Shaobo Deng, Paul Chen, Yun Li, Xiaochen Ma, Yanling Cheng, Xiangyang Lin, Lloyd Metzger, and Roger Ruan</i>	
9.1	Introduction	251
9.2	Principles	252
	9.2.1 Biological Effects	252
	9.2.2 Physical Principles	252
9.3	Equipment and Process Flow	255
9.4	Effects of the Process on Microorganisms and Quality	258
	9.4.1 Microorganisms	258
	9.4.2 Quality	259
9.5	Other Uses of CHIEF Technology	261
9.6	Future Development	261
	9.6.1 Hardware Development	262
	9.6.2 Evaluation of the Process	262
	9.6.3 Hurdle Technology	262
	Acknowledgements	263
	References	263
10	Bacteriocins of Food Grade Lactic Acid Bacteria in Hurdle Technology for Milk and Dairy Products	267
	<i>John A. Renye, Jr and George A. Somkuti</i>	
10.1	Introduction	267
10.2	Bacteriocin Structure and Production	268
10.3	Application of Bacteriocins in Dairy Foods	273
	10.3.1 Applications to Improve Food Safety	274
	10.3.2 Sensory Effects of Bacteriocin Applications	275
	10.3.3 Bacteriocin Resistance	276
10.4	Bacteriocins as Components of Hurdle Technology	277
	10.4.1 Combined with Conventional Treatments	277
	10.4.2 Combined with Emerging Technologies	280
10.5	Bacteriocins in Hurdle Technology for Dairy Food Safety	281
	10.5.1 Bacteriocins Combined with Temperature Regulation	281
	10.5.2 Bacteriocins Combined with Other Natural Preservatives	285
	10.5.3 Bacteriocins and Pulsed Electric Fields	287
	10.5.4 Bacteriocins and High-Pressure Processing	288
10.6	Conclusions	289
	References	290
11	Leveraging the Beneficial Compounds of Organic and Pasture Milk	307
	<i>Michael H. Tunick, Diane L. Van Hekken, and Moushumi Paul</i>	
11.1	Introduction	307
11.2	Regulatory Status	307
	11.2.1 Organic and Conventional Dairies	307
	11.2.2 Nutritional claims	308
11.3	Bioactive Compounds in Milk	311
	11.3.1 Peptides and Proteins	311
	11.3.2 Fatty Acids	313
	11.3.3 Vitamins and Minerals	314

11.4	Variations in Biologically Active Compounds	319
11.4.1	Pasture, Organic and Conventional Milk	319
11.4.2	Pasteurization and Homogenization	319
11.4.3	Feed Changes	320
11.5	The Future	321
11.5.1	Trends	321
11.5.2	Goals and Research Needs	322
	Disclaimer	322
	References	322
	Index	333

About the IFST Advances in Food Science Book Series

The Institute of Food Science and Technology (IFST) is the leading qualifying body for food professionals in Europe and the only professional organisation in the United Kingdom concerned with all aspects of food science and technology. Its qualifications are internationally recognised as a sign of proficiency and integrity in the industry. Competence, integrity, and serving the public benefit lie at the heart of the IFST philosophy. IFST values the many elements that contribute to the efficient and responsible supply, manufacture, and distribution of safe, wholesome, nutritious, and affordable foods, with due regard for the environment, animal welfare, and the rights of consumers.

IFST Advances in Food Science is a series of books dedicated to the most important and popular topics in food science and technology, highlighting major developments across all sectors of the global food industry. Each volume is a detailed and in-depth edited work, featuring contributions by recognized international experts, and which focuses on new developments in the field. Taken together, the series forms a comprehensive library of the latest food science research and practice, and provides valuable insights into the food-processing techniques that are essential to the understanding and development of this rapidly evolving industry.

The IFST Advances series is edited by Dr Brijesh Tiwari, Senior Research Officer in the Department of Food Biosciences at the Teagasc Food Research Centre, Dublin, Ireland.

Current and forthcoming titles in the IFST series

Emerging Dairy Processing Technologies, edited by Nivedita Datta and Peggy Tomasula

Emerging Technologies in Meat Processing, edited by Enda Cummins and James Lyng

Seafood Processing: Technology, Quality and Safety, edited by Ioannis S. Boziaris

Nutraceutical and Functional Food Processing Technology, edited by Joyce Irene Boye

List of Contributors

Laetitia M. Bonnaillie, Dairy and Functional Foods Research Unit, United States
Department of Agriculture, Agricultural Research Service, Eastern Regional
Research Center, Wyndmoor, PA, USA, Wyndmoor, PA, USA

Jayani Chandrapala, Advanced Food Systems Research Unit, College of Health and
Biomedicine, Victoria University, Melbourne, Victoria, Australia

Paul Chen, Department of Bioproducts and Biosystems Engineering and
Department of Food Science and Nutrition, University of Minnesota, St Paul, MN,
USA

Yanling Cheng, Department of Bioproducts and Biosystems Engineering and
Department of Food Science and Nutrition, University of Minnesota, St Paul, MN,
USA

Nivedita Datta, College of Health and Biomedicine, Victoria University, Melbourne,
Victoria, Australia

Shaobo Deng, Department of Bioproducts and Biosystems Engineering and
Department of Food Science and Nutrition, University of Minnesota, St Paul, MN,
USA

Poornimaa Harimurugan, College of Health and Biomedicine, Victoria University,
Melbourne, Victoria, Australia

Sinead P. Heffernan, School of Food and Nutritional Sciences, University College
Cork, Ireland

Thom Huppertz, NIZO food research, Ede, The Netherlands

Alan L. Kelly, School of Food and Nutritional Sciences, University College Cork,
Ireland

Yun Li, Department of Bioproducts and Biosystems Engineering and Department of
Food Science and Nutrition, University of Minnesota, St Paul, MN, USA

Xiangyang Lin, Department of Bioproducts and Biosystems Engineering and
Department of Food Science and Nutrition, University of Minnesota, St Paul, MN,
USA

Xiaochen Ma, Department of Bioproducts and Biosystems Engineering and
Department of Food Science and Nutrition, University of Minnesota, St Paul, MN,
USA

Lloyd Metzger, Dairy Foods Research Center and Department of Dairy Science,
South Dakota State University, Brookings, SD, USA

Vijay K. Mishra, College of Health and Biomedicine, Victoria University,
Melbourne, Victoria, Australia

Daniel M. Mulvihill, School of Food and Nutritional Sciences, University College
Cork, Ireland

Enzo A. Palombo, Department of Chemistry and Biotechnology, Faculty of Science,
Engineering and Technology, Swinburne University of Technology, Australia

Moushumi Paul, Dairy and Functional Foods Research Unit, United States
Department of Agriculture, Agricultural Research Service, Eastern Regional
Research Center, Wyndmoor, PA, USA, Wyndmoor, PA, USA

Lata Ramchandran, College of Health and Biomedicine, Victoria University,
Melbourne, Victoria, Australia

John A. Renye, Jr, Dairy and Functional Foods Research Unit, United States
Department of Agriculture, Agricultural Research Service, Eastern Regional
Research Center, Wyndmoor, PA, USA, Wyndmoor, PA, USA

Dolores Rodrigo, Instituto de Agroquímica y Tecnología de Alimentos
(IATA-CSIC), Paterna (Valencia), Spain

Roger Ruan, Department of Bioproducts and Biosystems Engineering and
Department of Food Science and Nutrition, University of Minnesota, St Paul, MN,
USA

Fernando Sampedro, Center for Animal Health and Food Safety (CAHFS), College
of Veterinary Medicine, University of Minnesota, St Paul, MN, USA

George A. Somkuti, Dairy and Functional Foods Research Unit, United States
Department of Agriculture, Agricultural Research Service, Eastern Regional
Research Center, Wyndmoor, PA, USA, Wyndmoor, PA, USA

John Tobin, Moorepark Food Research Centre, Fermoy, County Cork, Ireland

Peggy M. Tomasula, Dairy and Functional Foods Research Unit, United States
Department of Agriculture, Agricultural Research Service, Eastern Regional
Research Center, Wyndmoor, PA, USA, Wyndmoor, PA, USA

Michael H. Tunick, Dairy and Functional Foods Research Unit, United States
Department of Agriculture, Agricultural Research Service, Eastern Regional
Research Center, Wyndmoor, PA, USA, Wyndmoor, PA, USA

Diane L. Van Hekken, Dairy and Functional Foods Research Unit, United States
Department of Agriculture, Agricultural Research Service, Eastern Regional
Research Center, Wyndmoor, PA, USA, Wyndmoor, PA, USA

Daniela D. Voigt, School of Food and Nutritional Sciences, University College Cork,
Ireland

Bogdan Zisu, School of Applied Sciences, College of Science, Engineering and
Health, RMIT University, Melbourne, Victoria, Australia

Preface

Milk and milk products have attracted consumer attention as functional foods due to the abundance of bioactive compounds, such as proteins, peptides, fatty acids, vitamins and minerals, found in a single serving. Milk and milk products have been shown to support healthy bones, teeth and muscles; may reduce the risk of high blood pressure, stroke and cardiovascular disease; and may control type 2 diabetes and obesity. A little known fact is that a serving of milk provides 100% of the adult daily requirement of Vitamin B12, about 30% of the adult daily requirement of Vitamin B2 and appreciable amounts of the other B vitamins.

Even though consumption of milk products such as cheese, yogurt and ice cream continues to grow, consumption of fluid milk has declined in recent years, with many consumers claiming that its taste and flavour pale in comparison to those of other beverages on the market today. In addition to claiming some health and nutritional benefits, these beverages offer convenience, taste and quench thirst. Varieties of milk-based products could be offered to cater to different consumer needs if they had a longer refrigerated or stable shelf life. High temperature, short time (HTST) pasteurization is used in milk processing to improve the microbial safety of milk and extend its refrigerated shelf life but its use in creation of specialty milk beverages or products is not always suitable for creation of extended shelf life (ESL) or shelf stable products.

Emerging Dairy Processing Technologies: Opportunities for the Dairy Industry presents state of the art research and information on the alternative technologies that have some potential to be used, alone or in conjunction with another processing technology such as traditional thermal pasteurization or sterilization processes, for ESL or shelf stable products. These technologies include: pulsed electric fields, high hydrostatic pressure, high pressure homogenization, ohmic and microwave heating, microfiltration, high power ultrasound, ultraviolet and pulsed light processing, carbon dioxide processing and application of bacteriocins produced from food grade lactic acid bacteria as components of hurdle technology for milk and dairy products or post processing milk preservation. Because of their growing importance to consumers, the additional bioactive compounds that may be found in milk from pasture-fed cows due to their dietary regime and other factors are described; the many health benefits they confer and their stability during processing are also discussed.

The primary focus of this book is on the effects of the alternative technologies on milk and milk product safety but the additional effects on their quality are also discussed. In fact, it is likely that some of the technologies may never find application in pasteurization or sterilization treatments but are worthy of consideration because they

may induce physical changes of milk components that can be beneficial for the development of novel milk and dairy products and new ingredients. Some of the affected attributes are also covered in this book.

Information on alternative milk processing techniques and their impact on the physical, chemical and functional properties of milk and dairy products is scattered throughout the literature. *Emerging Dairy Processing Technologies: Opportunities for the Dairy Industry* consolidates the available information from various research groups into one place, which will provide significant benefits to the end users, including the food and dairy industries.

Nivedita Datta
Victoria University, Melbourne, Australia
Peggy Tomasula
USDA/ARS/ERRC, Wyndmoor, USA

1

Crossflow Microfiltration in the Dairy Industry

Peggy M. Tomasula and Laetitia M. Bonnaillie

Dairy and Functional Foods Research Unit, United States Department of Agriculture/Agricultural Research Service/Eastern Regional Research Center, USA

1.1 Introduction

1.1.1 Membrane Types

Since their introduction in the 1960s, pressure driven, crossflow or tangential filtration membrane technologies have become important in the food processing industries. The dairy industry currently uses crossflow membrane technologies for applications such as fractionation of the casein and whey proteins, whey protein concentration, demineralization of whey, removal of somatic cells and bacteria from milk, and milk concentration to save transport costs (Pouliot, 2008; Gésan-Guiziou, 2010). Membranes are also used alone or with the evaporation step in the manufacture of milk powders, and are increasingly being used in the development of new dairy-based beverages, fermented milk beverages and yogurt products. They are also finding a place in clean-in-place (CIP) processes to recover cleaning agents or to recover water used in processing (Alvarez *et al.*, 2007; Luo *et al.*, 2012).

Four types of membranes are used by the dairy industry: reverse osmosis (RO), nanofiltration (NF), ultrafiltration (UF) and microfiltration (MF). The operating parameters for crossflow filtration membranes are shown in Figure 1.1. The pressure-driven feed, with flow rate, Q_F , flows through the membrane channel parallel to the surface of the membrane. The applied pressure, P_F , must overcome the osmotic pressure, π_F , of the feed solution (Cheryan, 1998). The crossflow velocity (CFV), the velocity of the feed as it flows parallel to the membrane through the channel, has a sweeping effect that minimizes build-up of the feed particles on the membrane surface.

Some of the feed stream containing the smaller molecules flows through the walls of the membrane leaving as the permeate, with flow rate, Q_P , and pressure P_P . Q_P is often reported as the permeate flux, J , defined as the volume of permeate per unit membrane surface area per time. P_P has a gauge pressure reading of 0.0 if the stream

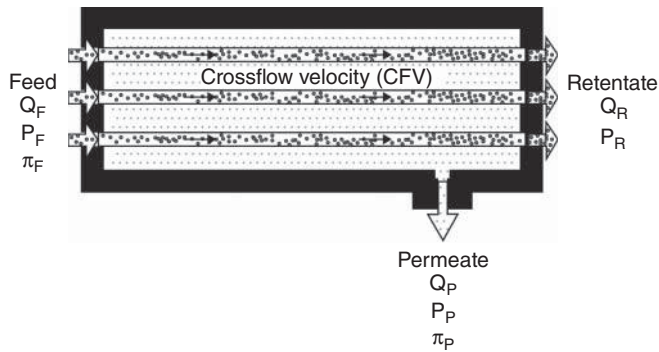

Figure 1.1 Parameters for crossflow filtration. Cross-section of a crossflow microfiltration housing for multiple membrane tubes shown.

is open to the atmosphere. The remainder of the stream, called the retentate, with flow rate, Q_R , and pressure, P_R , flows out the end of the membrane. This stream may be entirely or partially recycled back to the feed. The size distribution of the particles in the permeate and the retentate depend on the pore size distribution of the membrane. The pressure-driving force is reported in terms of the transmembrane pressure (TMP) and is given by:

$$\text{TMP} = (P_F - P_R)/2 - P_P \quad (1.1)$$

Table 1.1 shows the sizes of the milk nutrients, somatic cells and species that may populate milk, such as bacteria, spores, yeasts and moulds, and the corresponding types of membranes that would be used to separate them from smaller milk components. The wide ranges in sizes for bacteria and spores reported in Table 1.1 account for their possible lengths and widths (Garcia *et al.*, 2013). The operating pressure ranges and the separation technologies that compete with the particular membrane type are also listed. Particles smaller than the rating or pore or cut-off size leave in the permeate stream, particles larger than the pore size remain in the retentate. For RO and NF, the membranes are rated by salt rejection standards defined by the manufacturer. UF membranes are rated by a molecular weight cut-off size (MWCO) and MF membranes are rated by pore size.

RO, which may be used for milk or cheese whey concentration and to concentrate milk to save on transport costs, mostly retains the milk solutes, allowing only water to pass through the membrane. NF, which is also known as leaky RO, since it allows monovalent ions to pass through the membrane along with water, can also be used for concentration and, for example, in whey demineralization to purify lactose from cheese whey by removing salt, or to reduce water hardness in dairy plants (Cheryan, 1998; Pouliot, 2008; Gésan-Guiziou, 2010). The driving force for RO and NF is osmotic pressure. Depending on the cut-off size, UF, the most commonly used membrane process in the dairy industry, produces a retentate of proteins and fat, with the permeate containing minerals, nonprotein nitrogen and lactose. UF is used for protein standardization of cheese milk, to concentrate whey, for lactose-reduced milk and to fractionate the whey proteins. MF, depending on the membrane pore size, has been used to pretreat whey to remove fat, casein fines and bacteria prior to manufacture of

Table 1.1 Membrane pore size and operating pressure ranges, milk component sizes, size range and alternative processing methods. The corresponding MW range is in parentheses

Membrane Type/ Range	Pressure Range (KPa)	Milk Component	Size Range	Alternative Process
Microfiltration 0.1 μm – 10 μm (~100 – 1000 kDa)	10 – 350	Somatic Cells	8 – 10 μm	Centrifugation
		Fat	0.1 – 15 μm ; 3.4 μm average	
Microfiltration/ Ultrafiltration		Bacteria/Spores	0.2 – 10 μm	
		Yeasts, moulds	1 – 10 μm	
Ultrafiltration 0.001 – 0.1 (1 – 500 kDa)	30 – 1050	Casein micelles	0.110 μm ; average 0.02 – 0.3 μm	Centrifugation
		Immunoglobulins	150 – 900 kDa	
Nanofiltration 0.2 – 2 kDa	1000 – 4000	Whey proteins	0.03 – 0.06 μm	Evaporation, Distillation
		α -lactalbumin	14 kDa	
		β -lactoglobulin	18 kDa	
		BSA	66 kDa	
		lactoferrin	86 kDa	
		GMP	8 – 30 kDa	
		Enzymes	13 – 100 kDa	
Reverse Osmosis	1300 – 8000	Lactose	0.35 kDa	Distillation, Evaporation, Dialysis
		Salts		
		Vitamins		
		Water		
		Ions		

Data from Brans *et al.*, 2004, and Garcia *et al.*, 2013.

whey protein concentrates by UF (Cheryan, 1998), to remove bacteria from milk and for production of micellar casein and whey protein from milk.

Currently, MF has limited use in the dairy industry, with an installed membrane area of 15 000 m² compared to that of UF with an installed area of 350 000 m² (Garcia *et al.*, 2013). This chapter reviews the theory and experimental techniques used in research on MF and then focuses on the current status of MF for removal of bacteria from milk to create extended shelf life (ESL) milk, processes which use MF to separate milk into value-added enriched fractions and newer developments in MF applications. The greenhouse gas emissions, energy use and estimated costs for a fluid milk processing plant are compared to those for the same plant with an MF installation.

1.1.2 MF Membranes

Membranes used in the dairy industry are semipermeable and are manufactured to achieve various pore sizes and pore size distributions tailored for a particular

application. MF membranes for dairy applications have a well defined pore size distribution and are manufactured from ceramic materials or polymeric materials. Milk MF is usually performed with membranes in tubular form (ceramic membranes) or, in limited applications, a spiral-wound (SW) design (polymeric) to fit laboratory, pilot plant and commercial scale equipment.

Ceramic membranes have an asymmetric structure consisting of two layers. The top layer, also known as the skin layer or active membrane layer, is very thin and, depending on the pore size and pore size distribution, is a factor in determining the performance of the membrane in terms of fouling. Fouling lowers the permeate flux, J , and may also prevent or alter the transmission of the feed components to the permeate. The bottom layer is a macroporous support structure for the membrane (Figure 1.2). Ceramic membranes are made from metal oxides such as zirconia, titania, or alumina and silica and formed into tubes. MF membranes for dairy applications are usually made from alpha-alumina. Polymeric SW membranes for MF are manufactured mainly from poly(vinylidene fluoride) (PVDF). Their manufacture is not discussed here but details can be found elsewhere (Cheryan, 1998).

Regardless of membrane type, membranes for the dairy industry must be able to withstand the rigorous cycling of chemicals and high temperatures during cleaning. The PVDF SW membranes can withstand temperatures up to about 60°C but are susceptible to chemical cleaning, which limits their use to about one year (Cheryan, 1998). Ceramic MF membranes are more expensive than the SW membranes and can withstand liquid temperatures of up to approximately 95°C, but the actual temperature limits are set by the tolerances of the gaskets and o-rings to the higher temperatures and chemical cleaning. These membranes can last for up to 10 years (Cheryan, 1998).

Hydrophilic membranes are chosen for milk processing applications because they minimize protein binding by the hydrophobic proteins that contribute to fouling and affect permeability (Bowen, 1993). Their high surface tension attracts water molecules

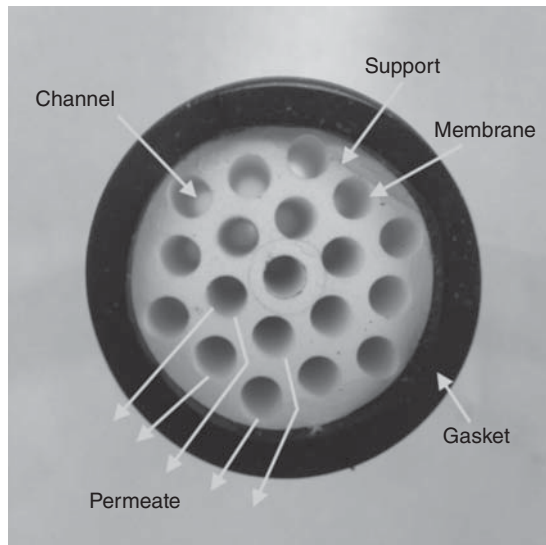

Figure 1.2 Cross-section of a ceramic membrane tube.

to the surface; this helps to prevent protein fouling. Ceramic membranes are naturally hydrophilic, since they are derived from the hydrophilic metal oxides. PVDF membranes are hydrophobic but are available in modified form to reduce hydrophobicity (Liu *et al.*, 2011).

In addition to hydrophilicity, the charge, surface roughness and morphological properties of the membrane and the sizes and tortuosity of the membrane pores have also been shown to affect the extent of fouling by proteins (Bowen, 1993; Cheryan, 1998). For example, milk has a pH of 6.6, with many of its proteins negatively charged. It would be expected that a negatively charged membrane would be more preferable for milk processing than a positively charged membrane. However, many of the ionic species in milk, particularly calcium, would bind to the membrane and, in turn facilitate, binding of the negative proteins and phosphates (Bowen, 1993).

The selectivity is also an important consideration when choosing a membrane. Selectivity may be adversely affected by the pore size distribution, uneven TMP across the membrane and fouling (Brans *et al.*, 2004). A large pore size distribution may result in undesired transmission or retention of milk components adversely affecting permeate composition. Uneven TMP across ceramic membranes, typically caused by the high CFV required for high permeate flux, J , causes variations in permeate flux that may lead to fouling on and in the pores of the membrane and undesired transmission and retention of milk components.

In the late 1980s, the uniform transmembrane pressure (UTP) process was developed by Alfa-Laval to address uneven TMP in milk MF (Sandblom, 1978; Malmberg and Holm, 1988; van der Horst and Hanemaaijer, 1990). The process is known as 'Bactocatch'. The Bactocatch process operates by addition of a pump to recirculate the permeate through the permeate side of the membrane cocurrently with the retentate. Plastic balls added to the permeate side decrease the amount of permeate required and, thus, the pump size. This modification was shown to result in a constant pressure drop on both sides of the membrane so that J on the order of 500 l/m²/h with almost complete transmission of the milk proteins, and total bacteria retention could be sustained for 10 hours with low fouling (Saboya and Maubois, 2000). However, this method incurs higher operating costs due to the additional permeate recycle pump.

More recently, graded permeability (GP) membranes (Pall Corporation) and Isoflux membranes (Tami Industries) have been introduced; these do not require installation of an additional pump as in the Bactocatch process to maintain uniform J and low fouling. The GP membranes include a longitudinal permeability gradient in the support structure, which is located around the active membrane layer, that maintains TMP along the length of the membrane. The Isoflux membranes include a change in thickness in the active layer to maintain TMP, and thus J , along the length of the membrane. MF plants today use either the UTP process or the GP and Isoflux membranes.

The ceramic membranes used to process milk are multichannelled tubes, up to 1.2 m long with 3–39 channels (Figure 1.2). The channels are usually circular with inner diameters ranging from 2 to 6 mm. Isoflux membrane tubes have multichannel configurations named daisy, sunflower and dahlia, in which the channels are roughly triangular in shape. These patterns provide more surface area per tube, thus increasing J . Star-shaped channels, which provide more surface area than circular channels, are also available for membranes.

For small-scale pilot testing, a single tube is placed in a housing and installed in the supporting MF equipment. In larger pilot-scale equipment or commercial-scale operations processing several litres of milk per hour, several tubes are placed in a single

housing and then installed. Commercial plants use several housings. These configurations affect the method for calculating CFV.

For a single membrane channel

$$\text{CFV} = Q_F / 3600 A_{xs} \quad (1.2)$$

Q_F is the flow rate of the feed to the channel and A_{xs} ($= \pi d^2/4$) is the cross-sectional area of a single channel with diameter, d . If a membrane has several channels, as shown in Figure 1.2, then $A_{xs} = n \pi d^2/4$, where n is the number of channels. For a membrane module in which several membrane elements are contained in a housing (Membralox, 2002), $A_{xs} = Nn\pi d^2/4$, in which N is the number of membranes in the housing.

1.1.3 Pilot Plant Testing

Milk MF is typically conducted using a 1.4 μm membrane at temperatures ranging from 40 to 55°C, with 50°C the most commonly used. CFV ranges from 5 to 9 m/s with CFV and TMP chosen so that J is optimized. TMP typically ranges from 30 to 50 KPa (Cheryan, 1998; Brans *et al.*, 2004) for the UTP process but is higher for the GP and Isoflux membrane processes, with reported values ranging from 50 to 200 KPa depending on CFV (Fritsch and Moraru, 2008; Skrzypek and Burger, 2010; Tomasula *et al.*, 2011). Higher values of TMP are observed for the smaller membrane pore sizes (Tomasula *et al.*, 2011; Adams and Barbano, 2013). For applications involving removal of bacteria and spores from milk, only skimmed milk is filtered because of the overlap in sizes of the bacteria and spores with that of the fat globules (Table 1.1). A 1.4 μm membrane is used for skimmed milk MF, although 0.8 μm membranes may optionally be used since they are more effective for spore removal (Tomasula *et al.*, 2011).

A schematic diagram of a pilot plant MF process is shown in Figure 1.3. Several companies provide the equipment necessary for pilot testing of milk MF in batch or continuous modes in skid form. This equipment is of sanitary construction and usually includes a 115 or 190 litre feed tank, single or multiple membrane modules, a recirculation pump with variable speed drive, a heat exchanger, pressure gauges and transducers to measure the inlet and outlet pressures, thermocouples, flow meters and valves for control of the permeate and retentate flows, and process control equipment. CFV is controlled using the recirculation pump and the retentate valve. Many units are equipped with an optional back-pulsing system, which is used to push foulant from the membrane to be cleared by the CFV. This is accomplished by applying pressure on the permeate side so that $P_p > P_f$. The frequency and duration of the pulses may be varied. Back-pulsing is limited to the pilot scale.

Prior to running a milk MF pilot process, the membrane is cleaned according to the manufacturer's instructions. Then, water MF is conducted to determine the clean water flux, CWF, to ensure that it is approximately the same value determined from previous experiments.

$$\text{CWF} = (Q_f * \mu / (\text{TMP} * A)) \quad (1.3)$$

where Q_f is the water flow rate in l/h; μ is the water viscosity, 0.001 Pa-s at 20°C; and A is the membrane surface area for filtration, m^2 . If CWF is not in agreement with previous values, the membrane should be cleaned according to the manufacturer's protocol, and tested again. Inability to clean the membrane may be indicative of irreversible fouling. After successful testing of the CWF, skimmed milk is charged to the

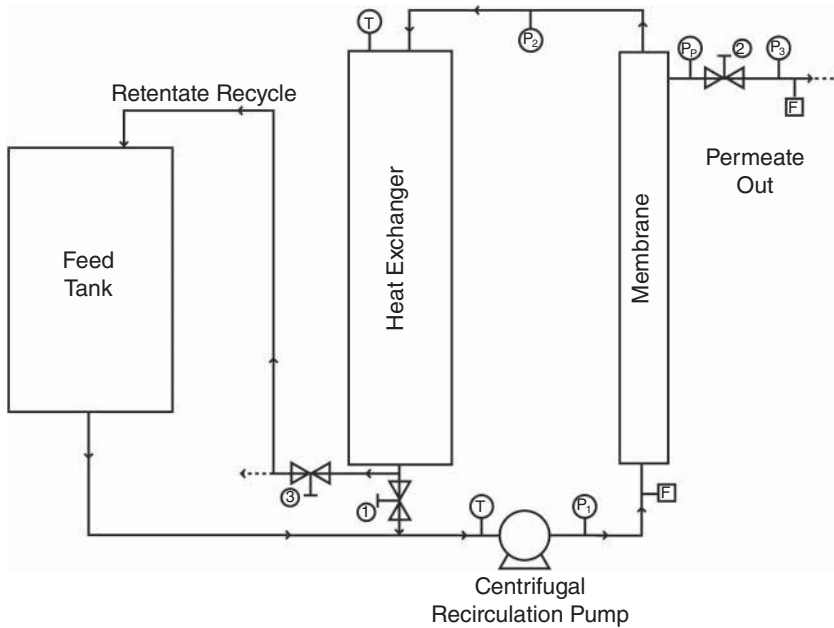

Figure 1.3 Schematic diagram of MF process skid showing batch filtration with full recycle of retentate. P_1 , P_2 , P_3 and P_p are pressure gauges; (1), (2) and (3) are valves; T is a temperature thermocouple.

holding vessel and then pumped to the membrane at 50°C. The weight of the permeate may be determined as a function of time to determine the experimental permeate flux, J , in $\text{l/m}^2/\text{h}$, often reported as LMH.

$$J = \text{weight permeate (kg)} / (A \rho t) \quad (1.4)$$

A is the surface area of the membrane, m^2 ; ρ is the permeate density (kg/m^3) at MF temperature; and t is the time (hours).

Experimental processes are typically conducted in batch mode with most of the retentate recycled back to the feed tank and the permeate collected. To achieve a particular volume concentration reduction (VCR), for example a VCR of 20, or 20× concentration, the following relationship is used:

$$\text{VCR} = V_F/V_R = V_F/(V_F - V_P) \quad (1.5a)$$

where V_F is the volume of feed; V_R the volume of retentate; and V_P the volume of permeate.

VCR for a continuous process is defined as:

$$\text{VCR} = (Q_P + Q_R)/Q_R \quad (1.5b)$$

where Q_P is the flow rate of the permeate and Q_R is the flow rate of the retentate. VCR may also be referred to as a volume concentration factor or concentration factor.

Research to develop models for correlation and prediction of J for various milk species–membrane interactions is carried out continuously (Kromkamp *et al.*, 2007; Kuhn *et al.*, 2010). Selection of the appropriate membrane for a milk MF application should include pilot plant testing with a particular membrane to verify that the desired production rate, permeate composition, quality attributes, and process economics will be met. Consultations with vendors are also recommended.

1.2 MF Principles and Models

For the ideal case of flow of a fluid through a microporous membrane, the flow rate of the permeate stream, J , is given by Darcy's law (Cheryan, 1998):

$$J = \text{TMP} / \mu R_m \quad (1.6)$$

where μ is the solution viscosity and R_m is the intrinsic resistance of the membrane for pure water. However, J for a fluid such as milk is often less than the ideal value because of boundary layer formation, concentration polarization and fouling effects that can act as a secondary membrane along the surface of the membrane (Schulz and Ripperger, 1989; Merin and Daufin, 1990; Bowen, 1993; James *et al.*, 2003). In addition to fouling that occurs due to the protein–membrane interactions discussed previously, other causes of fouling are: pore blockage, resulting in partial or total closure of pores; deposits of particles, or cake layer formation, which grow in layers at the surface of the membrane and over time act as an additional resistance to permeate flow; and gel formation of macromolecules, arising from concentration polarization (Belfort *et al.*, 1994; Bacchin *et al.*, 2006).

The temperature effects of milk MF on J are included in the viscosity term of Equation 1.6. As temperature increases, the viscosity of milk decreases, which leads to increased J (Whitaker *et al.*, 1927; Alcântara *et al.*, 2012). The viscosity of milk may also vary with pH and age (McCarthy and Singh, 1993). Permeate flow, J , for milk MF at 53°C was shown to be approximately 85% greater than that at 6°C due to the decreased viscosity (Fritsch and Moraru, 2008).

When milk MF is conducted in the range from 40 to 55°C, the viscosity of milk varies from 1.04 cP (0.00104 Pa s) to 0.77 cP (0.00077 Pa s) (Whitaker *et al.*, 1927), which indicates a difference in viscosity over the MF temperature range of approximately 25%. However, temperature increases also lead to an increase in protein diffusivity, which may reduce concentration polarization and fouling, but there may be an increase in internal fouling of the membrane (Marshall *et al.*, 1993).

The flow of milk at high CFV across a MF membrane helps prevent the build-up of particles along its surface but is associated with boundary layer formation due to shear stress at the membrane wall (Cheryan, 1998). The boundary layer includes the velocity profile along the wall at which the velocity is a minimum to the point where it is approximately the velocity of the bulk stream. Because the membrane is porous, the amount of water in the milk stream is decreased at the wall due to the permeate flow and is accompanied by an increased concentration of milk proteins. This is concentration polarization, which is also referred to as a gel or cake layer; it forms due to the dynamic and reversible layer of milk proteins (Figure 1.4). This layer can be removed through the proper selection of operating conditions such as CFV and TMP.

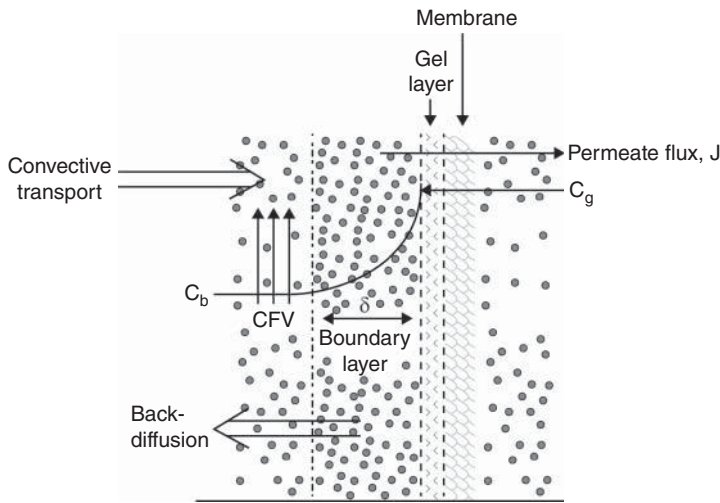

Figure 1.4 Concentration polarization.

Fouling of the membrane may be reversible or irreversible. A reversible fouling layer is indicated by a slow decline in J with MF run time and is difficult to reverse with changes in CFV or TMP alone. It may be reversed using back-pulsing, as discussed previously, although this technique is not always successful for sustained MF operations.

For MF, it was hypothesized (Field *et al.*, 1995; Howell, 1995) that at a particular CFV, J is a linear function of TMP until a critical flux, J_{crit} , is reached at TMP_{crit} . Increasing TMP above TMP_{crit} initiates membrane fouling and increases J further. Strong and weak forms of J_{crit} were proposed. The strong form is characterized by a linear plot of J as a function of TMP, similar to that observed for water MF. The weak form is also linear but various membrane interactions decrease J relative to that of water.

The performance of J as a function of TMP in three distinct regions has been described for MF (Field *et al.*, 1995; Howell, 1995; Brans *et al.*, 2004). Milk MF in the subcritical region ($TMP < TMP_{crit}$) (Region 1 or the pressure-controlled region) is desirable for optimal selectivity of the membrane with minimal fouling (Figure 1.5). Although selectivity is optimal, a larger membrane surface area is needed because of low J (Brans *et al.*, 2004). Increasing CFV or temperature at a fixed TMP also increases J . In Region 2, when $TMP > TMP_{crit}$ and $J > J_{crit}$, J is optimal and less membrane surface is required, but selectivity is not optimal. With further increases in $TMP > TMP_{crit}$, J approaches a limiting value, J_{lim} , independent of TMP as the fouling or gel layer increases in thickness. The capacity of the membrane is then saturated by fouling (Belfort *et al.*, 1994; Bacchin *et al.*, 2006) and J becomes independent of membrane pore size. Milk MF for bacteria reduction and for casein micelle concentration from milk is conducted from the boundary of Regions 1 and 2 and into Region 2 (Brans *et al.*, 2004). In Region 3, as the fouling layer builds, compaction of the layer may occur, decreasing J further because of membrane pore blockage (Chen *et al.*, 1997). Back-pulsing would be required to control the fouling. There may also be an abrupt decline in J , as shown in Figure 1.5. Upon reduction in TMP, hysteresis

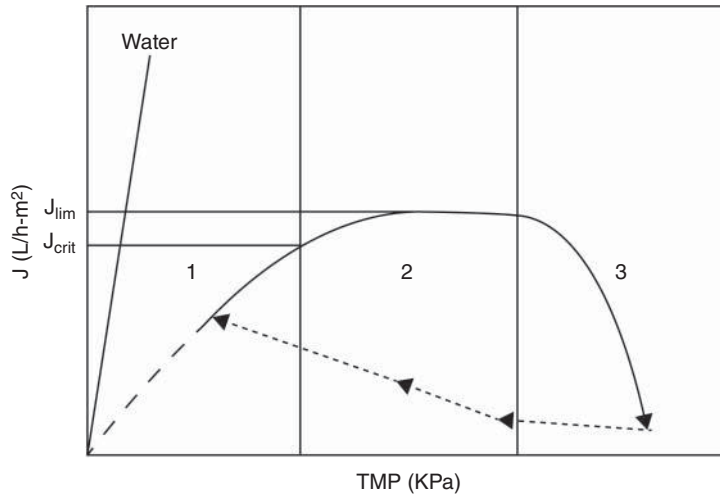

Figure 1.5 Dependence of flux, J , on transmembrane pressure (TMP). The pressure-controlled region is approximated by Region 1 and the mass-transfer-controlled region by Region 2. Increasing CFV or temperature at a fixed TMP also increases J .

in the curve is noted and J is not restored to its initial value (Chen *et al.*, 1997; Guerra *et al.*, 1997; Tomasula *et al.*, 2011).

Semi-empirical and empirical models have been developed to obtain an understanding of the dependence of J on TMP in the subcritical region and the characteristic shift from the pressure-controlled region to the pressure-independent, mass-transfer-controlled region, as J_{crit} and J_{lim} are approached (Figure 1.5). The models are of three general types: film or gel-polarization theory models, osmotic pressure models to determine J_{lim} , and resistance models. Variations of these models have also been described but are not discussed here (Bowen and Jenner, 1995).

1.2.1 Gel Polarization Models

The film theory model was first applied to ultrafiltration (Bowen and Jenner, 1995) and assumes that the solute particles of milk migrate from the bulk stream toward the membrane surface by convective transport and return to the bulk stream by back-diffusion (Figure 1.4).

At steady-state, a boundary layer forms with thickness, δ . The mass transfer coefficient is given by:

$$k = D/\delta \quad (1.7)$$

where D is the diffusion coefficient. If a critical concentration of a solute particle, for example the milk proteins or casein, is reached at the membrane surface (Guerra *et al.*, 1997; Tomasula *et al.*, 2011), a gel layer may form restricting permeate flow. J is then given by (Cheryan, 1998):

$$J = k \ln (C_g/C_b) \quad (1.8)$$

where C_g is the concentration of the solute at the membrane surface or the gel concentration and C_b is the concentration of the solute in the bulk of solution (milk).

C_g is termed C_M , concentration at the membrane, if a gel layer is not formed. J for this model predicts J_{lim} , the limiting flux.

The Leveque equation for laminar flow or the Dittus–Boelter equation for turbulent flow may be used to determine k , which is related to the Sherwood number, Sh , (Bowen, 1993) but does not give an exact representation for CFV and other empirical representations may be found more suitable. For turbulent flow, defined by Reynolds number, $N_{Re} > 4000$, the Dittus–Boelter expression is (Cheryan, 1998):

$$Sh = 0.023(N_{Re})^{0.8}(Sc)^{0.33} \quad (1.9)$$

where

N_{Re} = Reynolds number = $D_h V \rho / \mu$

Sc = Schmidt number = $\mu / \rho D$

D_h = hydraulic diameter = 4 (cross-section available for flow/wetted perimeter of the channel).

The gel polarization model is useful for estimating J_{lim} when the concentration of the gel layer at the surface of the membrane is at constant C_g . However, since it lacks a pressure term and does not account for other operating conditions, it does not describe cases in which $J < J_{crit}$ (Samuelsson *et al.*, 1997; Cheryan, 1998; Ripperger and Altmann, 2002).

1.2.2 Osmotic Pressure Model

The osmotic pressure model (Jonsson 1984; Wijmans *et al.*, 1984; Prádānos *et al.*, 1995) for J takes into account the operating conditions and the osmotic pressure term, π_M , in Darcy's equation (Bowen, 1993; Cheryan 1998):

$$J = (TMP - \Delta\pi_M) / R_m \quad (1.10)$$

$\Delta\pi_M$ is the osmotic pressure difference across the membrane but is approximated by π for a concentrated solute, such as milk proteins or casein at the membrane surface in the case of milk MF, and is calculated in terms of virial coefficients, A_n (Cheryan, 1998):

$$\pi_M = A_1 C_M + A_2 C_M^2 + A_3 C_M^3 + \dots \quad (1.11)$$

C_M is the concentration at the membrane surface and may be calculated from film theory (Equation 1.8). R_M is the intrinsic membrane resistance determined for pure water. Depending on the value of C_M , the higher order terms of Equation 1.11 may become important, increasing the value of π_M so that it approaches TMP, resulting in a decrease in J .

The gel polarization and osmotic pressure models are useful for understanding the dependence of J_{lim} on operating conditions. While the gel polarization model is useful for predicting the dependence of J on C_b or CFV, it requires the appropriate Sherwood correlation to estimate k and only applies to Region 2, the mass-transfer-dependent region of Figure 1.5. The osmotic pressure model does not assume deposition or

adsorption of proteins but relies on the availability of osmotic pressure data to calculate the pressure difference across the membrane given in Equation 1.10. A unified model for prediction of J across the three regions of Figure 1.5 is still not available.

1.2.3 Resistance–in-Series Model

The model most commonly used to correlate experimental data for J as a function of time is the resistance-in-series model given by Darcy's law:

$$J = (\text{TMP} - \Delta\pi) / \mu R_{\text{total}} \quad (1.12)$$

If $\Delta\pi$ is negligible:

$$R_{\text{total}} = R_m + R_d \quad (1.12a)$$

R_{total} is the total hydraulic resistance (m^{-1}) which may be estimated from the final average value of J obtained from several milk MF trials performed under the same operating conditions. R_m is the resistance of the clean membrane obtained from CWF (Equation 1.3). R_d includes other resistances attributed to reversible, $R_{f,\text{rev}}$, and irreversible, $R_{f,\text{irrev}}$, fouling with:

$$R_d = R_{f,\text{rev}} + R_{f,\text{irrev}} \quad (1.12b)$$

Some models further define $R_{f,\text{rev}}$ and $R_{f,\text{irrev}}$ to specifically account for adsorption, pore blocking, and other possible fouling mechanisms (Bowen and Jenner, 1995). $R_{f,\text{rev}}$ is due to adsorption of milk components by the membrane that occurs with MF operations mainly in Region 1. It may be calculated from the values of R_{total} and R_m , since $R_{f,\text{irrev}}$, fouling that cannot be removed with changes in CFV or TMP during an experiment, is negligible in Region 1. Experimentally, the contribution of $R_{f,\text{irrev}}$ may be obtained by rinsing the membrane with deionized water after a milk MF trial for approximately 20 minutes to remove $R_{f,\text{rev}}$ (Tomasula *et al.*, 2011). $J_{f,\text{irrev}}$ is then the value of J for the rinsed membrane and $R_{f,\text{rev}}$ may then be determined from Equations 1.12a and 1.12b if there is irreversible fouling. $R_{f,\text{irrev}}$ would occur mainly in Region 3. Determination of resistances in Region 3 may require use of the osmotic pressure term, $\Delta\pi$, in Equation 1.12 which becomes important at high TMP.

Figure 1.5 shows an example of irreversible fouling at $J > J_{\text{lim}}$ in Region 3. In this case, it was hypothesized that compaction of the gel layer, consisting mainly of casein, increased the hydraulic resistance across the membrane. This would result in an increase in the osmotic pressure at the surface of the membrane approaching that of TMP and a decrease in J (Tomasula *et al.*, 2011).

To demonstrate the effects of pressure of a casein deposit on a membrane, compression and relaxation of casein with changes in pressure were observed through dead-end microfiltration experiments with a polyethersulfone (PES) UF membrane. The feed was either native phosphocaseinate powder or a sodium caseinate powder dispersed in UF skimmed milk permeate. The resistance to flow through the casein deposit was found to depend on the internal porosity of the casein micelle, which was controlled by the degree of compression (Pignon *et al.*, 2004; Qu *et al.*, 2012). A critical osmotic pressure, π_{crit} , was also defined as the compressive pressure to achieve a critical concentration of casein micelles and the point at which phase transition for the formation of an irreversible deposit is initiated. In future experiments, the effects of CFV and TMP on the casein deposit during crossflow milk MF and the properties of π_{crit} will be examined.

1.3 Applications of MF

1.3.1 Production of Concentrated Micellar Casein and Whey Proteins

Whey protein concentrates are produced from cheese whey using UF. An alternative method to produce whey concentrates uses MF with a skimmed milk feed instead of cheese whey to produce concentrated micellar casein in the retentate and native whey proteins or serum proteins (SPs) in the permeate. The casein in the concentrate is in its native micellar form, unlike acid casein, which is denatured when precipitated from milk using acids. SPs are a potential alternative to whey protein concentrates obtained from cheese making with the added benefits of not being denatured or containing any residual products from cheesemaking and lower fat content. Micellar casein and SP protein concentrates may also be dried or blended depending on application.

The UTP concept and later development of the GP and Isoflux membranes led to improved processes to produce micellar casein and SPs directly from skimmed or whole milk. Polymeric membranes were used in early studies but were subject to fouling and low selectivity due to a wide pore-size distribution (Brans *et al.*, 2004). Since polymeric SW membranes cost less than ceramic MF membranes, many recent studies have been conducted to determine the efficacy of PVDF SW membranes for milk separation.

Early studies for the removal of native casein micelles from skimmed milk used ceramic membranes with pore sizes ranging from 0.05 to 0.2 μm (Brans *et al.*, 2004) but low values of J were reported. It was noted that since similar values of J were consistently reported even though TMP and pore sizes were dissimilar, MF was conducted in the pressure-independent region (Region 2) and that J was most likely equal to J_{crit} . Higher values of J were noted when a Kenics static mixer was inserted into a 0.1 μm membrane to change membrane hydrodynamics.

Zulewska *et al.* (2009) compared the efficiency of SP removal from skimmed milk using the UTP process with 0.1 μm membranes, an MF system equipped with 0.1 μm GP membranes and an MF system equipped with a 0.3 μm PVDF SW membrane. The processes were operated in a continuous bleed-and-feed 3 \times concentration factor mode. SP removal was 64.4%, 61.04% and 38.6% for the UTP, GP and SW processes, respectively, compared to the theoretical SP removal rate of 68.6%. The relative proportions of casein to SP for the respective processes were reported as 93.93/6.07, 93.14/6.86 and 90.03/9.97, compared to 82.93/17.08 for skimmed milk. The values of J for the UTP, GP and SW membranes were 54.1, 71.8 and 16.2 $\text{kg}/\text{m}^2/\text{h}$, and indicated that SP removal was most efficient for the UTP ceramic membrane but more SP would be removed for the GP membrane during an MF trial due to higher J , although the permeate was slightly cloudy compared to the clear UTP permeate. It was concluded that the SW membranes would require additional membrane surface area or several diafiltration steps to achieve the SP removal of the UTP and GP membranes.

In another study, Hurt *et al.* (2010) demonstrated SP removal for a three-stage, 3 \times UTP system with 0.1 μm MF ceramic membranes and with water diafiltration between the stages, to determine the amount of SP removed relative to the theoretical values. Cumulative SP removal for the first, second and third stages was 64.8, 87.8 and 98.3%, respectively, compared to the theoretical values of 68, 90 and 97% SP, respectively. In comparison, an SW system using a 0.3 μm membrane was estimated to require more than eight stages, including five water diafiltration stages, to remove 95% of SP from skimmed milk (Beckman *et al.*, 2010). Reduced passage of SPs through the SW

membrane was attributed to fouling by casein, which increased the hydraulic resistance (Zulewska and Barbano, 2013).

Later experiments with a 0.14 μm Isoflux membrane (Adams and Barbano, 2013) showed SP removal efficiency (70.2%) similar to the SW membrane (70.3%) after three stages. The GP membrane showed a removal efficiency of 96.5%. It was expected that the Isoflux membrane would have a removal efficiency similar to that of the GP membrane. The authors offered several reasons for the performance of the Isoflux membranes in this application: some pore sizes were too small for passage of SPs, reverse flow conditions and the selective layer modification served to reduce the effective surface area of the membrane, and the shape of the membrane channels promoted fouling and rejection of SPs.

Karasu *et al.* (2010) noted that SW membranes provide performance similar to ceramic membranes but that at the industrial scale high hydraulic pressure drops and low TMP are difficult to achieve unless shorter membrane lengths are used. For ceramic membranes, Piry *et al.* (2012) constructed a module containing four sections to assess the effect of membrane length on fouling effects, J and beta-lactoglobulin (β -LG) transmission. Maximum β -LG transmission depended on the position along the membrane.

Quality of Micellar Casein Concentrate and Serum Proteins The stability of micellar casein concentrates (MCCs) under sterilization processing is critical for their use as ingredients in shelf-stable, high protein beverages. Sauer and Moraru (2012) found that MCC is unstable when subjected to sterilization. UHT treatment was found to induce coagulation of MCC while retorting caused an increase in particle size, possibly due to solubility loss of calcium phosphate and dissociation of the casein micelles. MCC was found to be stable though when pH was increased, temperature was decreased, or both, although the composition and size of the MCC micelles differed from the original MCC micelles.

In a comparison of 34% SP concentrate (SPC) with WP concentrate (WPC) made from the same milk (Evans *et al.*, 2009), SPC had lower fat and calcium contents, higher pH and did not contain glycomacropeptide (GMP) from cheese making. Upon rehydration at 10% solids, the SPC solutions were clear and the WPC solutions were cloudy. Sensory differences were related to the differences in fat content and the compounds generated from the starter culture and were minor but distinct. Flavour differences were mild in SPC and WPC made from the same milk compared to commercial WPC.

Commercial Developments Skrzypek and Burger (2010) reported that four commercial plants using 0.14 μm Isoflux membranes were in operation in Poland and the Czech Republic to produce MCC for casein standardization of skimmed or fat standardized milk in Quark production. Quark was described as an unripened acidic white cheese, made using traditional methods, which leads to an acid whey by-product that cannot be disposed of owing to environmental regulations. Use of MCC, microfiltered using a VCR of 1.6–2, may reduce the amount of acid whey generated by the Quark process by 40–60%. The authors state that the sweet whey permeate MF product is also used for protein standardization in the manufacture of spray dried milk and other milk-based products.

Skrzypek and Burger (2010) also reported commercial production of MCC with VCR of 2–6 corresponding to a 49% and a 72% level of true proteins in the retentate,

respectively, with the ratio of casein/true protein exceeding 90%. The plant capacities ranged from 10 000 to 23 000 l/h depending on desired VCR. Four MF modules of 50 m² each are used in a two-stage MF plant. The SP permeate is concentrated by NF and then spray-dried or spray-dried after mixing with milk or milk derivatives.

Native WP containing 24% alpha-lactalbumin (α -LA) and 65% β -LG, obtained by MF using polymeric membranes, demonstrated improved *in vitro* functional properties compared to cheese WP (Shi *et al.*, 2012). Results indicated that the anti-obesity effects of native WP obtained by MF are inferior to those of α -LA, but it protects against diet-induced obesity during weight loss due to its α -LA content.

Alternative Processes for MCC and SP Production Still in development are rotating disks, rotating membranes and vibrating systems (Jaffrin, 2008). In an example of milk MF, a laboratory rotating disk module equipped with six ceramic disks with pore size of 0.2 μ m rotating around a shaft inside a cylindrical housing was used for MCC and SP production using a pasteurized skimmed milk feed at 45°C (Espina *et al.*, 2010). A UF dynamic filtration followed milk MF to separate the whey proteins, α -LA and β -LG. TMP was a low of 60 KPa and was a function of the inner and outer radii and the angular velocity of the membrane disks. Permeate flux, J, was highest (90–95 LMH) at VCR of 1. Casein rejection was reported as high as 99% with α -LA and β -LG transmission through the membrane of 0.8 and 0.98, respectively.

1.3.2 Extended Shelf Life Milk

With good quality raw milk, aseptic filling and packaging in standard containers (packaged nonaseptically), and careful handling during storage and distribution to maintain temperature below 6°C, extended shelf life (ESL) milk has a shelf life ranging from a few days to up to 28 days under refrigeration (Goff and Griffiths, 2006) and as long as a reported 45 days (Rysstad and Kolstad, 2006). The shelf life for milk is established when the total bacterial count is >20 000 CFU/ml (FDA, 2011) after a certain length of time. According to Saeman *et al.* (1988), shelf life is determined by proteolysis, which generates off-flavours when the decrease in casein as a percentage of true protein (CN%TP) is greater than 4.76%. Maintenance of refrigeration temperature below 4°C will lead to the longest shelf life of milk.

ESL milk is known commercially as ultrapasteurized (UP) milk that was heated at a temperature $\geq 137.8^\circ\text{C}$ for ≥ 2 s and packaged nonaseptically. Ultra high temperature (UHT) pasteurized milk is also ESL milk if filled and packaged aseptically making it shelf-stable for about six months. ESL milk may also be heat treated at a temperature of 125°C and held for four seconds or heated to 127°C with a hold time of five seconds (Goff and Griffiths, 2006), after preheating at temperatures ranging from 70 to 85°C. However, while heat treatment ensures the safety of milk, it is also associated with cooked flavours, impaired functionality and loss of cheese making ability. Inactivated bacterial cells remain in the milk with any still active enzymes leading to reduced shelf life. Unfortunately, the temperatures used for ESL milk may also activate spores of *Bacillus* spp. (Goff and Griffiths, 2006), some of which have the potential to germinate and grow under refrigeration temperatures, without competition from other organisms. Use of bacto-fugation (te Giffel and van der Horst, 2004) or MF would reduce the level of bacteria and spores prior to the heat treatment used in production of ESL milk, or production of UHT milk. Bacto-fugation is not discussed in further detail in this chapter. However, Westfalia Separator Group claims that installation of

two separators in series before milk separation will remove up to 90% of total bacteria before pasteurization and reduce *Bacillus cereus* spore counts to less than one spore in 10 ml of milk. The milk is claimed to have a shelf life of 20 days with taste judged similar to that of high temperature, short time (HTST) pasteurized milk.

ESL milk, manufactured using MF followed by HTST pasteurization, commercially microfilters only skimmed milk because of the overlap in sizes between bacteria and spores and the milk fat globules as shown in Table 1.1. The MF equipment is installed after the separator and before the pasteurization step. Membrane pore size is typically 1.4 μm but a 0.8 μm membrane may be used. The retentate, which can range in volume from approximately 0.5% of the skimmed milk feed at VCR of 200, to 5% for VCR of 20, contains somatic cells and the bulk of bacteria removed from the skimmed milk when concentrated (Elwell and Barbano, 2006; Hoffman *et al.*, 2006). Typical operating conditions for milk MF using a 1.4 μm membrane in the UTP process at 50°C are TMP of about 50 KPa, CFV from 6 to 9 m/s and average J of 500 LMH for a 10 hour run (Saboya and Maubois, 2000). Few studies of operating conditions for the Isoflux or GP membranes have been reported for milk MF (Fritsch and Moraru, 2008; Tomasula *et al.*, 2011); but with the exception of higher values of TMP, which may range from about 50 to 200 KPa depending on CFV, operating conditions and J are within those reported by Saboya and Maubois (2000) for the UTP process. Caplan and Barbano (2013) reported a shelf life of 90 days for skimmed milk and 2% fat milk prepared by MF using a 1.4 μm membrane followed by HTST pasteurization at 73.8°C for 15 seconds.

Several potential plant configurations incorporating the MF process in an existing HTST fluid milk process are possible. The retentate may be added to the cream stream, heat treated at 130°C for four seconds and then added to the skimmed milk permeate followed by homogenization and HTST pasteurization. Alternatively, cream may be added to the permeate stream with high-temperature-treated retentate added to the surplus cream, which undergoes heat treatment at 130°C for four seconds. The retentate may also be directed back to the separator (te Giffel and van der Horst, 2004) or may be treated by UHT heating at 143°C for 1.1 seconds and discarded or used elsewhere (Hoffman *et al.*, 2006). Other variations of this process have been reported, such as addition of another MF stage with VCR of 10 to follow the first stage with VCR of 20 to reduce the volume of the retentate stream to about 0.5% of the feed. In this case then, the retentate would be 200 \times concentrated and would not be used. Other variations of a MF milk process have been proposed by Hoffmann *et al.* (2006) which did not use the retentate to make ESL milk.

MF using a 1.4 μm membrane produces a permeate free of somatic cells with log reductions of bacteria averaging from 2.6 to 5.6 (Trouvé *et al.*, 1991; Pafylas *et al.*, 1996; Elwell and Barbano, 2006). Log reductions of bacterial spores of 2–3 log were reported in the permeate (Elwell and Barbano, 2006; Hoffman *et al.*, 2006). While the permeate is free of somatic cells, the retentate may contain only about 25% of their original number (Elwell and Barbano, 2006), possibly due to the exposure to shear forces on the retentate side caused by the membrane itself or by the pump as it recycles the retentate stream through the membrane.

A milk MF process using a 0.8 μm membrane was proposed by Lindquist (2002) and became known as the Tetra Pak Ultima process (Maubois, 2011). MF conducted at 50°C with J of 4001 m^2/h resulted in a sterile permeate with a decimal reduction of 13 (calculated from cellular volume) for *Clostridium botulinum* and a decimal reduction of nine for *Bacillus pumilus*. The milk permeate was aseptically mixed with

UHT-treated cream for fat standardization. This was followed by homogenization and then heat treatment of the stream at 96°C for six seconds to inactivate endogenous milk enzymes. The milk product was packaged aseptically and had a reported shelf life of 180 days at 20°C. The process was not commercialized.

Skrzypek and Burger (2010) reported that there are more than 10 commercial milk MF lines in Austria, Germany and Switzerland, installed in standard HTST pasteurization lines, processing from 15 000 to 35 000 l/h. The shelf life of the milk is from 20 to 25 days. In these plants, the skimmed milk stream is microfiltered using Isoflux membranes with a pore size of 1.4 µm and the cream stream is heated to a maximum of 135°C after addition of the retentate. The cream/retentate stream is added to the permeate and then pasteurized to produce the ESL milk. Bacteria removal from 60 000–160 000 to fewer than 10 counts/ml, corresponding to a log reduction of 4.20–3.78 log₁₀/ml, was reported. Aerobic spore counts were from 40 to 210 spores/ml milk, corresponding to 1.60–2.32 log₁₀ spores/ml, prior to MF/HTST pasteurization with only 3/35 analyses showing 1 spore/ml remaining in the permeate.

Schmidt *et al.* (2012) investigated the biodiversity of ESL manufactured by MF followed by HTST pasteurization and stored at 4, 8 and 10°C to investigate changes in bacterial counts, microbial diversity and enzyme quality. Biodiversity analyses were also conducted for samples from five manufacturers of commercial ESL milk at the end of shelf life. Even though MF reduced microbial logs by about 6 log₁₀ CFU/ml, bacterial counts ranged from <1 to 8 log₁₀ CFU/ml, with 8% of samples showing spoilage indicated by counts >6 log₁₀ CFU/ml. The spoilage groups of bacteria were identified as post-process contaminants that included *Sphingomonas*, *Psychrobacter*, *Chryseobacterium* and *Acinetobacter*, and the spore formers *Bacillus cereus* and *Paenibacillus*, which caused enzymatic spoilage and off-flavours. Only three out of 13 isolates were identified as psychrotolerant genotypes. Overall, discrepancies in microbial loads and microflora varied even in samples of the same production run. The authors attributed this to stochastic variation of initial species in the milk packages arising from the low numbers of bacterial counts after ESL treatment. Thus, different bacterial populations would be observed during cold storage as well as occasional growth of high numbers of pathogenic species.

It is often assumed that milk MF is a nonthermal process. Even though MF is conducted over the temperature range 40–55°C, it is also assumed that energy use and the associated carbon dioxide (CO₂) emissions of MF followed by HTST pasteurization at a lower pasteurization temperature are less than that for HTST pasteurization conducted at a higher temperature alone. Using a computer simulation model of the fluid milk process developed recently (Tomasula and Nutter, 2011; Tomasula *et al.*, 2013, 2014), a fluid milk process with MF/HTST (Figure 1.6) was simulated for comparison of energy use, greenhouse gas (GHG) emissions and operating costs to retrofit a plant using HTST pasteurization alone. The assumed production rate was 27 000 l/h of milk. The MF section was modelled assuming two MF processing modules in series, with each containing housings for 1.4 µm membranes. The first MF module was fed by milk at 55°C leaving the separator. The retentate from the first module fed the second module. The VCR of the first module was assumed to be 20 and that of the second 10, for an overall VCR of 200. Permeate from both modules was combined with cream, homogenized and then HTST pasteurized at 72°C to produce whole milk. The retentate, which was about 0.5% of the total feed stream, was processed as waste. Results showed that electricity and natural gas use for the MF/HTST process, which extended from the milk silos to cold storage at the plant, were 0.16 and 0.13 MJ/L, respectively,

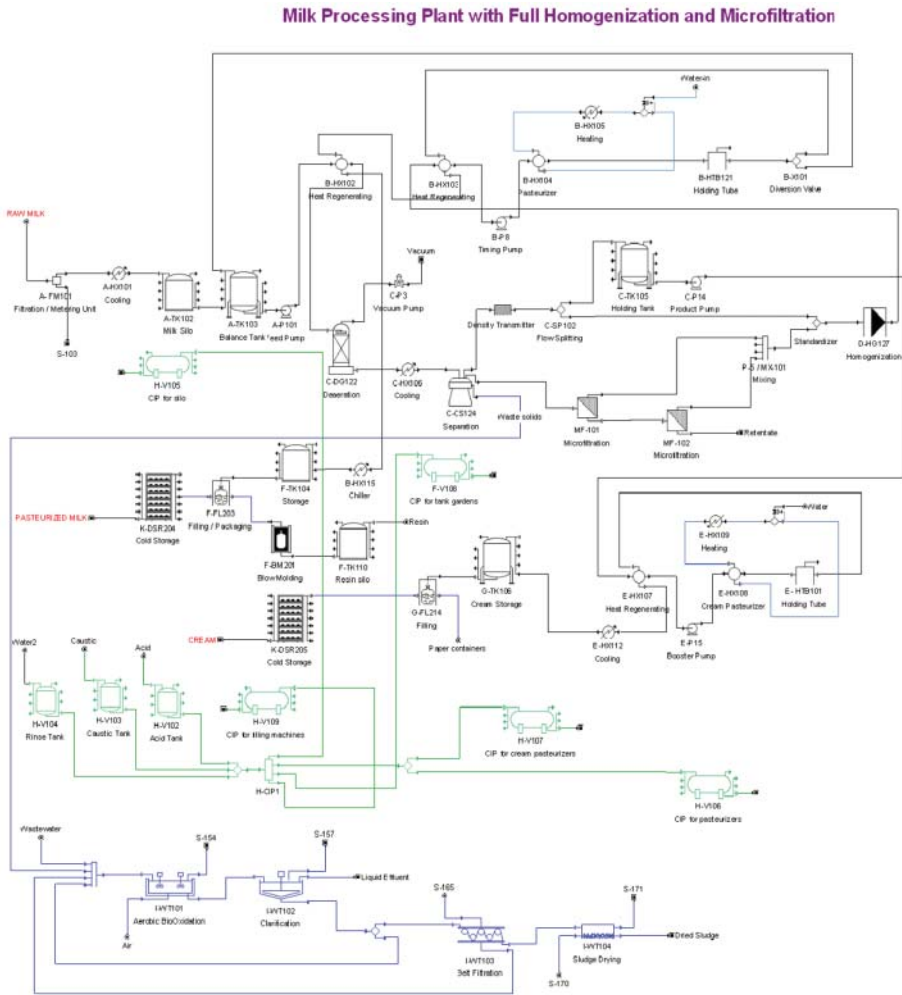

Figure 1.6 Milk Processing Plant with Full Homogenization and microfiltration.

and the carbon footprint of milk was $40.7 \text{ g CO}_2\text{e/kg}$ milk. For HTST pasteurization alone conducted at 77°C , electricity and natural gas use were 0.14 and 0.13 MJ/l, and the carbon footprint of milk was $37.6 \text{ g CO}_2\text{e/kg}$ milk (Tomasula *et al.*, 2014). Addition of MF prior to HTST pasteurization increased electricity use. The natural gas use increased due to the lower regeneration efficiency, which resulted from the 0.5% retentate waste, which in turn lowered the overall flow rate of milk. Less energy is thus regenerated because of the lower flow rate, in what was assumed to be an existing pasteurizer. The difference in operating costs between the two scenarios was estimated as 0.10 US cents/l. This is within the range reported by Skrzypek and Burger (2010).

The longer shelf life of the MF/HTST products may compensate for the small increase in GHG emissions of $3.1 \text{ g CO}_2\text{e/kg}$ milk noted for the process over HTST

pasteurization alone. Supply chain losses and waste as well as losses at the point of consumption may account for up to approximately 0.5 kg CO_{2e}/kg milk consumed due to the 12% losses at retail and an additional 20% loss from cooking, spoilage and waste due to consumer practices (Thoma *et al.*, 2013) it is conceivable that MF/HTST products would reduce retail and consumer losses due to their extended shelf life.

French regulatory authorities permit the sale of microfiltered whole milk, also known as ESL raw milk or Marguerite milk, which is not pasteurized. In this case, the cream is heat treated (95°C, 20 s), mixed with the permeate, lightly homogenized, filled aseptically and refrigerated at <6°C. The reported shelf life is about 15 days (Saboya and Maubois, 2000; Gésan-Guiziou, 2010). Using process simulation, the energy and natural gas usage for the MF process alone was 0.29 MJ/l with a hold time for cream of 15 seconds to ease comparison with the other models presented here. The GHG emissions were 41.4 CO_{2e}/kg milk. The increase in GHG emissions relative to the HTST pasteurization process was due to the increased electrical usage associated with MF. Natural gas use was 0.14 MJ/kg.

To get around the requirement of skimmed milk use for MF because of the overlap in sizes of the bacteria and spores with that of fat globules, a process was developed (Maubois, 2011; Fauquant *et al.*, 2012) in which whole milk was homogenized twice prior to MF using a 0.8 µm Membralox membrane, at 50°C and J of 200 l/m²/h in one example, to obtain fat globules smaller than 0.3 µm in the UTP process. This reduced the size of the fat globules so that they passed through the membrane with most bacteria retained. The fat standardized milk was pasteurized at 72°C with a 20 second hold time and has a shelf life of 30 days if stored at 4°C. If the fat standardized milk is heat treated at 96°C with a six second hold time, milk with a shelf life of 180 days at 20°C is obtained. Significant fouling was not observed after an eight-hour run. Milk flavour was reported identical to that of pasteurized milk. This process is not for production of a raw milk product. MF is followed by pasteurization, which is necessary to destroy the native lipase, which causes lipolysis in homogenized milk.

Quality and Safety The quality of heated milk is evaluated using the heat indicators lactulose, furosine, β-LG and lactoperoxidase (Lan *et al.*, 2010). Lactulose is not present in raw milk but is formed upon heating through the isomerization of lactose. β-LG tends to decrease with heating due to denaturation while furosine, formed through the Maillard reaction, increases. Lactoperoxidase is used as an indicator to show that milk was heated over 80°C. Hoffman *et al.* (2006) measured the levels of several of these indicators for raw milk, skimmed milk, MF permeates and retentates, ESL milk treated by MF followed by HTST pasteurization and for the UHT-treated retentate. For the β-LG indicator, values of β-LG in the permeate were not affected by MF or the combination of MF and heat treatment but UHT treatment of the retentate resulted in a 90% decrease in β-LG. While furosine indicated that cream had been subjected to heat, the lactulose indicator showed values which agreed with HTST pasteurized milk.

In addition to achieving a longer shelf life than milk treated by HTST pasteurization alone, removal of somatic cells by MF prevents much of the lipolysis (the increase in free fatty acids) and proteolysis in milk associated with high or low somatic cell counts (Ma *et al.*, 2000) although proteolysis, the breakdown of casein by plasmin was still observed due to native milk proteases, which cause off-flavour development (Santos *et al.*, 2003; Elwell and Barbano, 2006). It was recommended that raw milk used in

MF should contain <100 000 somatic cells/ml to keep a low concentration of active plasmin, which passes through the microfilter and survives pasteurization.

MF followed by HTST pasteurization significantly reduces the microflora in milk (Trouvé *et al.*, 1991; Pafylas *et al.*, 1996; Elwell and Barbano, 2006; Tomasula *et al.*, 2011); however, few studies have been conducted to determine the efficacy of MF in eliminating human pathogens of concern that have been occasionally reported in raw milk, such as *Listeria monocytogenes*, *Salmonella* spp. or *E. coli* 0157:H7, that are destroyed by pasteurization. Since these pathogens are rod-shaped with an approximate width of 0.5 μm and length of 1.5 μm (Garcia *et al.*, 2013), MF would prevent most of these pathogens from entering the permeate, with pasteurization eliminating those in the permeate (Holsinger *et al.*, 1997). Using the Bactocatch method, *Listeria monocytogenes*, *Salmonella Typhimurium*, *Brucella abortus* and *Mycobacterium tuberculosis* inoculated into skimmed milk were reduced by 3.4, 3.5, 4.0 and 3.7 \log_{10} , respectively (Madec *et al.*, 1992; Saboya and Maubois, 2000). However, rod-shaped bacterial spores would survive pasteurization (Tomasula *et al.*, 2011) and would either die off during cold storage or grow (Novak *et al.*, 2005).

Few studies have determined the efficacy of MF in eliminating bacterial spores from milk using GP or Isoflux membranes. In a study examining methods to protect the milk supply from intentional addition of threat agents to milk prior to pasteurization, or to decontaminate milk, the impact of MF on removal of spores of *Bacillus anthracis* (BA) (Sterne) inoculated into raw milk was evaluated (Tomasula *et al.*, 2011). The length of the spores ranged from 1.09 to 2.13 μm and diameter ranged from 0.66 to 1.09 μm (Carrera *et al.*, 2007). Starting with raw milk inoculated with 6.5 \log_{10} spores BA/ml, MF using a 0.8 μm membrane retained $5.91 \pm 0.05 \log_{10}$ spores BA/ml of milk and a 1.4 μm membrane retained $4.50 \pm 0.35 \log_{10}$ BA spores/ml of milk. The operating conditions for the 0.8 μm membrane were 50°C, CFV of 6.2 m/s, TMP of 127.6 KPa with an average J of 273 LMH. CFV for the 1.4 μm membrane was 7.1 m/s, TMP was 127.6, with an average J of approximately 200 LMH. Casein as a percentage of crude protein decreased 1.5% for the 1.4 μm membrane and 4.3% for the 0.8 μm membrane after 200 minutes of operation. For MF run times >10 minutes, either the 0.8 μm membrane (1.4 μm membrane not tested) or the associated pumping of the recycle stream appeared to contribute to sporulation of BA during cold storage, even though the milk was HTST pasteurized after MF. This observation would not be expected for MF of raw milk naturally containing very few spores/ml of other *Bacillus* species.

Head and Bird (2013) examined removal of psychrotropic spores from milk protein isolate (MPI) feeds ranging from 5 to 15% solids content. *Bacillus mycoides* spores were inoculated into the MPI feeds as a surrogate for spores of *B. cereus* and microfiltered using 0.8 and 1.4 μm GP membranes, 2 and 5 μm membranes without GP modification, and a 12 μm membrane comprised of a support layer only. The results showed that the 12 μm membrane at CFV of 1.4 m/s was best for the 10 and 15 wt-% high solids feeds, with spore reductions of 2.6 and 2.1 \log_{10} , protein transmission of 90% and 96.5% and J of 123 LMH and 27 LMH, respectively. Back-flushing was suggested as a method to improve J and protein transmission.

1.3.3 Cold Processing MF of Milk

The term ‘cold pasteurization’ often refers to milk MF when used to remove bacteria and spores from milk, to produce ESL milk, or when used prior to cheese making or manufacture of raw milk cheeses (Brans *et al.*, 2004). It may also be associated with

MF when used as a pretreatment for skimmed milk in any dairy process to remove somatic cells and bacteria that may impact the quality and safety of the final product during prolonged storage, such as NFD (nonfat dry milk) powder.

To attain shelf life and quality benefits beyond that of milk microfiltered at 50°C, MF processing of milk at temperatures <6.7°C to maintain the raw status of milk was studied (Fritsch and Moraru, 2008). Processing at these low temperatures may also avoid the potential problem of biofilm formation by bacteria that deposit on the large surface area of the membrane at the higher MF temperatures.

Vegetative cells, spores and somatic cells were removed at a CFV of 7 m/s, TMP of 60–80 kPa, and temperature of 6°C. J was approximately 50 LMH compared to 350 LMH for milk MF conducted at 55°C. To increase J at 6°C, a CO₂ back-pulsing technique was used; this increased J by 20% by clearing fouling in the outer membrane channels. Improvements to the back-pulsing technique, including the addition of injection ports around the membrane housing and the membrane, were suggested to improve J.

Pulsed electric fields (PEF) processing has also been combined with MF (1.4 μm membrane) for cold pasteurization of milk in two different sequences: MF prior to PEF (MF/PEF) and PEF prior to MF (PEF/MF) (Walkling-Ribiero *et al.*, 2011) and is discussed in further detail in Chapter 5. Milk MF was conducted at 35°C with J of 660 LMH. MF/PEF processing of milk at a maximum temperature of 49°C resulted in a 4.8 log₁₀ reduction in mesophilic aerobic counts of native microorganisms of milk. PEF/MF treatment of milk at a maximum processing temperature of 49°C resulted in a 7.1 log₁₀ reduction of inoculated native microorganisms. The shelf life of PEF/MF milk and that of HTST pasteurized milk stored at 4°C was seven days. Although it would be intuitive to expect that the MF/PEF sequence would be more effective for reduction of microorganisms in milk, the authors believed that PEF may have induced agglomeration of the microorganisms resulting in a higher log count.

With the observation that low temperatures cause release of β-casein from the casein micelles, Woychik *et al.* (1992) applied microporous ultrafiltration of skimmed milk to facilitate removal of β-casein from milk. Flat plate PVDF membranes 0.1 or 0.2 μm in size were used. Casein/whey ratios of 0.7–0.9 were obtained in the permeates and ratios of 5–7 were obtained in the retentates. Higher amounts of α_{s2}-casein and lower amounts of β-casein were noted in the permeate than in the retentate. The retentate was suggested as a potential replacer for human milk. Van Hekken and Holsinger (2000) also applied this process to produce unique β-casein enriched milk gels with the potential to make simulated goats' milk cheeses. A milk MF process using SW membranes in which the permeate contains the whey proteins and β-casein was also developed (Lucey, 2012, Lucey and Smith, 2012). Suggested uses were for fortification of infant formula, cheese with improved meltability and bitterness, and using β-casein as a replacement for sodium caseinate in foaming and emulsification applications. Fractionation of whole milk was also found a possibility.

1.3.4 Separation and Fractionation of Milk Fat from Whole Milk or Buttermilk

Using MF as an alternative to centrifugation for separation of milk into skimmed milk and cream fractions may result in less damage to the fat globule membranes at low CFV and lead to cream with improved stability (Brans *et al.*, 2004). The process may also be more energy efficient than centrifugation.

While processes for isolation of the native casein and whey components have been commercialized, processes for separation of the milk fat globules according to their size are still in development. The milk fat globules range in size from 0.1 to 15 μm and average 3.4 μm in size (Table 1.1). The effects of differences in compositions of the individual milk fat globules, their contribution to the functional properties of foods and their role in health and nutrition are not well understood (Singh, 2006).

Goudéranche *et al.* (2000) used whole milk MF with a 2 μm 'special' ceramic membrane to prepare two fractions containing the larger and smaller milk fat globules without damaging the milk fat globule membrane (MFGM). Michalski *et al.* (2006) optimized milk fat MF using membranes with pore sizes of 2–12 μm . The sizes of the globules were found to affect the properties of cheeses (Michalski *et al.*, 2003, 2007), with smaller milk fat globules found useful in preparation of products with a finer texture. Using a similar MF technique optimized to select for small milk fat globules (about 1.6 μm) and large milk fat globules (about 6.6 μm), Lopez *et al.* (2011) determined that differences in composition varied according to size. The smaller milk fat globules contained higher amounts of the polar lipids, lower proportions of phosphatidylcholine and sphingomyelin in the MFGM and differences in the distribution of fatty acids. It was hypothesized that the sizes of the milk fat globules may play a role in delivery of biologically active compounds in the gastrointestinal tract of infants.

MF using a 0.5 μm membrane has been employed to obtain the valuable MFGM from buttermilk, which is a richer source of MFGM than whole milk (Astaire *et al.*, 2003; Morin *et al.*, 2007; Jiménez-Flores and Brisson, 2008). MF of buttermilk powder, whey and whey cream powders, coupled with supercritical fluid extraction (SFE) was shown to concentrate the lipids for possible new ingredients (Spence *et al.*, 2009a, 2009b, 2009c). The phospholipids (PL) were concentrated fivefold. Numerous health benefits are associated with the MFGM, which also appears to inhibit rotavirus activity (Fuller *et al.*, 2013).

1.3.5 Separation of Milk Bioactive Compounds

MF membranes, either alone or in combination with other types of membranes and unit operations, have also been used to extract bioactive components from milk, colostrum and whey. These bioactives, which have the potential to affect human health, may be included in food or consumer products to promote health and well-being. The isolation of growth factors, such as the insulin-like IGF-I, IGF-II, epidermal growth factor EGF, transforming growth factors TGF- β 1 and TGF- β 2, the basic fibroblast growth factor bFGF and the platelet-derived growth factor PDGF, using UF or MF membranes have been described (Pouliot and Gauthier, 2006, Gauthier *et al.*, 2006, Akbache *et al.*, 2009). Growth factors have been suggested for treatment of inflammatory gastrointestinal disorders, wound healing, bone tissue regeneration and skin diseases. Ollikainen *et al.* (2012) found that the ultimate TGF- β 2 growth factor recovery was 83% if pasteurized milk was used in the initial MF step and 93% if nonpasteurized milk was used. Ben Ounis *et al.* (2010) used MF to separate TGF- β 2 from WPI using a 0.8 μm membrane. Adjustments in pH and ionic strength and addition of λ -carrageenan facilitated removal of the growth factor, which was also enriched in immunoglobulins.

Manufacture of bioactive peptide-rich concentrates from whey is also a possibility using MF as a first step to reduce microbial contamination. Use of MF avoids

the potential change in bioactivity of the compounds that occurs with heat treatment (Tavares *et al.*, 2012).

1.3.6 Other Applications

Skrzypek and Burger (2010) also reported the use of Isoflux MF membranes (1.4 μm) for bacteria and spore reduction of cheese brine, which is reused during the cheese making process for cheese salting. About 100% of mould, yeast and *E. coli* are removed with greater than 99.9% reduction in total bacteria reported. MF provides an environmentally-sound solution to disposal of the brine but also eliminates the more labour intensive methods used previously.

Use of MF is not limited to bovine milk. Beolchini *et al.* (2004, 2005) investigated the use of MF for reduction of bacteria in bovine and ovine milk. Extending the shelf life of milk from goats, sheep and other animals, such as camels, may be of interest, since they are usually available only in areas where they are produced. MF to produce ESL products would help satisfy consumer demand for these unique milk products and increase profits for those who produce them.

1.4 Membrane Modifications to Increase Performance

Brans *et al.* (2004) discussed the various strategies proposed in the literature to improve membrane performance through reduction of fouling. The methods include: vibrating modules, rotating disks, scouring particles and air slugs to improve shear at the membrane (Jaffrin, 2008; Ahmad *et al.*, 2010; Espina *et al.*, 2010); turbulence promoters (Popovic and Tekic, 2011), pulsating crossflow and use of ultrasound (Mirzaie and Mohammadi, 2012) to improve back transport near the membrane; and use of electric fields to repel charged particles from the membrane. Disadvantages to use of these approaches included high power consumption, high capital investment, difficulty cleaning, equipment wear and difficulty in scaling up.

1.5 Microsieves

Microsieve technology is a promising alternative to improving J over that of conventional milk MF using ceramic tubular or SW membranes. Microsieves are manufactured from silicon nitride or polymers. To manufacture silicon nitride microsieves, photolithographic technologies are used to produce silicon wafers with a thickness of 1 μm . According to one manufacturer (Sievecorp, Inc., <http://www.sievecorp.com>), microsieves come in the form of six-inch [15 cm] wafers that are assembled in stacks containing 45 sieves/stack. Each wafer can process 165 l/h of liquid and each stack processes 7500 l/h of liquid with maximum viscosity of 40 cp and particle load to be retained of less than 1 g/l. The microsieves are available in pore sizes of 0.35 or 0.35 μm slits, 0.45 and 0.45 μm slits, and 0.8 and 0.8 μm slits. Frequent back-pulsing is required to prevent fouling and to control concentration polarization effects. The advantage of microsieves over conventional membranes is their controlled pore-size and consistent morphology.

Brito-de la Fuente *et al.* (2010) determined the effects of process variables on MF of commercial UHT-treated whole milk using a pilot plant crossflow microsieve membrane system. Five-litre volumes of milk were processed at 40°C. The membranes had 0.8 µm slits and a surface area of 4 cm². Values of J from 5000 to 27,000 l/m²/h, a minimum 10× greater than J reported for skimmed milk MF with ceramic membranes, were achieved with low TMP in the range from approximately 7 to 15 KPa. Run times of over two hours were possible. TMP and the frequency of back-pulsing were the most important variables to control fouling. Changes in the viscosity and particle size distribution of the components of the milk were not noted. In a comparison to HTST pasteurization, the energy demand of microsieves reported by the manufacturer was 30 kJ/kg versus a reported 220 kJ/kg for HTST pasteurization. Even though the energy demand reported for microsieves is low, this step would still need to be followed by a pasteurization step. Also, the capital and operating costs for microsieve MF were not reported.

Prior to experiments, the microsieves were pretreated to induce hydrophilicity of the hydrophobic silicon material. After a milk MF run, the microsieves were cleaned with an alkaline cleaning agent at 50°C and membrane integrity was tested before and after each experiment.

Girones i Nogue *et al.* (2006) reported the performance of polyethersulfone (PES) polymeric microsieves for skim milk MF at 7°C using a membrane with a pore size of 2 µm. PES microsieves, which were reported to have lower production costs than silicon microsieves, are manufactured using phase separation micromoulding and are available in pore sizes ranging from 0.5 to 5 µm. A crossflow module was used for experiments using an effective membrane area of 0.5×10^{-4} m² and channel height of 700 µm. Varying back-pulse frequencies were applied to prevent fouling. Operating pressure was reported as 2 KPa and J was reported as 1600 LMH. It was concluded that a smaller pore size membrane, which would retain bacteria, would still result in improved productivity relative to conventional MF. Back-pulsing was necessary to prevent J decline.

Milk proteins were reportedly not retained using either the silicon nitride or PES microsieves. The silicon and polymeric microsieves show impressive performance compared to crossflow milk MF. Microsieves may be the future of milk MF but research is needed on start-up/shut-down operations, sanitation and verification of quality and safety of milk after MF to validate their performance against conventional crossflow MF.

1.6 Conclusions

Although MF is a well-established technology, it has shown limited growth in the dairy industry compared to ultrafiltration. With advances in membrane manufacture, low fouling membranes are now available that ensure maintenance of the transmembrane pressure, and thus the permeate flux along the length of the membrane. Microfiltration, using membranes with pore sizes ranging from 0.1 to 10 µm, can be used for a variety of applications. Using the smallest pore sizes, concentrates of micellar casein and the whey proteins are possible, presenting the possibility of new beverages and ingredients on the market that can be used to exploit the functional properties and health benefits of these proteins. Membranes with various pore sizes are being explored for separation of the milk fat globules to manufacture dairy products

with improved texture and to produce individual fat globules and MFGM to better understand their role in health and nutrition. The biggest advantage of MF is its ability to allow for physical removal of microorganisms that lead to milk spoilage from milk. MF, used as a processing step prior to HTST or UHT heat treatment, has led to production of ESL milk and dairy-based beverages with improved organoleptic properties. The longer shelf life is also an advantage because it allows for creation of products with targeted nutritional benefits for example, products targeted to particular segments of the population such as children, the elderly or for post-workout needs. The longer shelf life would also help further the sales and distribution of milk from other animals. In addition, production of ESL milk may help lower the greenhouse gas emissions associated with retail and consumer wastes of milk.

Increasing permeate flux would decrease operating costs attributed to electricity use. On the horizon are alternatives to tubular ceramic or SW membranes, such as microsieve technology, in which permeate fluxes exceeding 10 times that of conventional membranes have been demonstrated. Additional research is needed to develop membranes that are resistant to fouling and chemical and heat degradation, and with active and passive characteristics to improve their selectivity so that all essential nutrients in milk may be used.

Acknowledgements

The authors thank Ms Winnie Yee for her contributions to the computer simulation model and Mrs Dina Grimes for her assistance with the figures.

Disclaimer

Mention of trade names or commercial products in this publication is solely for the purpose of providing specific information and does not imply recommendation or endorsement by the US Department of Agriculture. USDA is an equal opportunity provider and employer.

References

- Adams, M.C. and Barbano, D.M. (2013) Serum protein removal from skim milk with a 3-stage, 3x ceramic Isoflux membrane process at 50°C, *J Dairy Sci*, **96**: 1–15.
- Ahmad, A.L., Ban, Z.H. and Ooi, B.S. (2010) A three-dimensional unsteady hydrodynamic profile of a reciprocating membrane channel, *J Membr Sci*, **365**: 426–437.
- Akbache, A., Lamiot, E., Moroni, O. *et al.* (2009) Use of membrane processing to concentrate TGF-β2 and IGF-1 from bovine milk and whey, *J Membr Sci*, **326**: 435–440.
- Alcântara, L.A.P., Fontan, R.D.I., Bonomo, R.C.F. *et al.* (2012) Density and dynamic viscosity of bovine milk affect by temperature and composition, *Int J Food Engin*, **8**: 1–12.
- Alvarez, N. Gésan-Guiziou, G. and Daufin, G. (2007) The role of surface tension of reused NaOH on the cleaning efficiency in dairy plants, *Int Dairy J*, **17**: 404–411.
- Astaire, J.C., Ward, R., German, J.B. and Jimenez-Flores, R. (2003) Concentration of polar MFGM lipids from buttermilk by microfiltration and supercritical fluid extraction. *J Dairy Sci*, **86**: 2297–2307.

- Bacchin, P., Aimar, P. and Field, R.W. (2006) Critical and sustainable fluxes: theory, experiments and applications. *J Membr Sci*, **281**: 42–69.
- Ben Ounis, W.S., Gauthier, S.F., Turgeon, S.L. and Pouliot, Y. (2010) Separation of transforming growth factor-beta2 (TGF-beta 2) from whey protein isolates by crossflow microfiltration in the presence of a ligand, *J Membr Sci*, **351**: 189–195.
- Beckman, S.L., Zulewska, J., Newbold, M. and Barbano, D.M. (2010) Production efficiency of micellar casein concentrate using polymeric spiral-wound microfiltration membranes, *J Dairy Sci*, **93**: 4506–4517.
- Belfort, G., Davis, R.H. and Zydney, A.L. (1994) The behavior of suspensions and macromolecular solutions in crossflow microfiltration. Review, *J Membr Sci*, **96**, 1–58.
- Beolchini, F., Veglio, F. and Barba, D. (2004) Microfiltration of bovine and ovine milk for the reduction of microbial content in a tubular membrane: a preliminary investigation, *Desalination*, **161**: 251–258.
- Beolchini, F., Cimini, S., Mosca, L. *et al.* (2005) Microfiltration of bovine and ovine milk for the reduction of microbial content: Effect of some operating conditions on permeate flux and microbial reduction, *Sep Sci Technol*, **40**: 757–772.
- Bowen, R. (1993) Understanding the flux patterns in membrane processing of protein solutions and suspensions, *TIBTECH*, **11**: 451–460.
- Bowen, W.R. and Jenner, F. (1995) Theoretical descriptions of membrane filtration of colloids and fine particles: An assessment and review, *Adv Colloid Interface Sci*, **56**, 141–200.
- Brans, G., Schroën, C.G.P.H., van der Sman, R.G.M., and Boom, R.M. (2004) Membrane fractionation of milk: state of the art and challenges, *J. Membrane Sci*, **243**: 263–272.
- Brito-de la Fuente, E.B., Torrestiana-Sánchez, B., Martínez-González, E. and Mainou-Sierra, J.M. (2010) Microfiltration of whole milk with silicon microsieves: Effect of process variables, *Chem Eng Res Des*, **88**(5–6A): 653–660.
- Caplan, Z. and Barbano, D.M. (2013) Shelf life of pasteurized microfiltered milk containing 2% fat, *J Dairy Sci*, **96**: 8035–8046.
- Carrera, M., Zandomeni, R. O., Fitzgibbon, J. and Sagripanti, J.-L. (2007) Difference between the spore sizes of *Bacillus anthracis* and other *Bacillus* species. *J Appl Microbiol*, **102**: 303–312.
- Chen, V., Fane, A.G., Madaeni, S. and Wenten, I.G. (1997) Particle deposition during membrane filtration of colloids: transition between concentration polarization and cake formation, *J Membr Sci*, **125**: 109–122.
- Cheryan, M. (1998) *Ultrafiltration and Microfiltration Handbook*. Technomic Publishing Co, Lancaster, PA.
- Elwell, M.W. and Barbano, D.M. (2006) Use of microfiltration to improve fluid milk quality, *J. Dairy Sci.*, **89**(E. Suppl.): E10–E30.
- Espina, V., Jaffrin, M.Y., Ding, L. and Cancino, B. (2010) Fractionation of pasteurized skim milk proteins by dynamic filtration, *Food Res Int*, **43**: 1335–1346.
- Evans, J., Zulewska, J., Newbold, M. *et al.* (2009) Comparison of composition, sensory, and volatile components of thirty-four percent whey protein and milk serum protein concentrates, *J Dairy Sci*, **92**: 4773–4791.
- Fauquant, J., Robert, B. and Lopez, C. (2012) Method for reducing the bacterial content of a food and/or biological medium of interest containing lipid droplets, US Patent 2012/0301591 A1.
- FDA (Food and Drug Administration) (2011 revision). Grade “A”, Pasteurized Milk Ordinance. US Department of Health and Human Services, Public Health Service, Food

- and Drug Administration. <http://www.fda.gov/downloads/Food/FoodSafety/Product-SpecificInformation/MilkSafety/NationalConferenceonInterstateMilkShipments/NCIMSMModelDocuments/UCM291757.pdf>. (last accessed 27 December 2014).
- Field, R.W., Wu, D., Howell, J.A. and Gupta, B.B. (1995) Critical flux concept for microfiltration fouling, *J Membr Sci*, **100**: 259–272.
- Fritsch, J. and Moraru, C.I. (2008) Development and optimization of a carbon dioxide-aided cold microfiltration process for the physical removal of microorganisms and somatic cells from skim milk, *J Dairy Sci*, **91**: 3744–3760.
- Fuller, K.L., Kuhlenschmidt, T.B., Kuhlenschmidt, M.S. *et al.* (2013) Milk fat globule membrane isolated from buttermilk or whey cream and their lipid components inhibit infectivity of rotavirus in vitro, *J Dairy Sci*, **96**: 3488–3497.
- Garcia, L.F. Blanco, S.A. and Rodriguez, F.A.R. (2013) Microfiltration applied to dairy streams: removal of bacteria. *J Sci Food Agric*, **93**: 187–196.
- Gauthier, S.F., Pouliot, Y. and Maubois, J.L. (2006) Growth factors from bovine milk and colostrums: composition, extraction and biological activities, *Lait*, **86**: 99–125.
- Gésan-Guiziou, G. (2010) Removal of bacteria, spores and somatic cells from milk by centrifugation and microfiltration techniques. In: *Improving the Safety and Quality of Milk: Milk Production and Processing* (ed. M.W. Griffiths). Woodhead Publishing, Cambridge, pp. 349–372.
- Gironès i Nogué, M., Akbarysah, I.J., Bolhuis-Versteeg, L.A.M *et al.* (2006) Vibrating polymeric microsieves: Antifouling strategies for microfiltration, *J Membr Sci*, **285**: 323–333.
- Goff, H.D. and Griffiths, M.W. (2006) Major advances in fresh milk and milk products: Fluid milk products and frozen desserts, *J Dairy Sci*, **89**: 1163–1173.
- Goudéranche, H., Fauquant, J. and Maubois, J.L. (2000) Fractionation of globular milk fat by membrane filtration, *Lait*, **80**: 93–98.
- Guerra, A., Jonsson, G. Rasmussen, A. *et al.* (1997) Low cross-flow velocity microfiltration of skim milk for removal of bacterial spores. *Int Dairy J*, **7**: 849–861.
- Head, L.W. and Bird, M.R. (2013) The removal of psychrotropic spores from milk protein isolate feeds using tubular ceramic microfilters, *J Food Process Eng*, **36**: 113–124.
- Hoffman, W.C. Kiesner, C., Clawin-Rädecker, I. *et al.* (2006) Processing of extended shelf life milk using microfiltration. *Int J Dairy Technol*, **59**: 229–235.
- Holsinger, V.H., Rajkowski, K.T. and Stabel, J.R. (1997) Milk pasteurization and safety: a brief history and update, *Rev Sci Tech Off Int Epiz*, **16**: 441–451.
- Howell, J.A. (1995) Sub-critical flux operation of microfiltration. *J Membr Sci*, **107**: 165–171.
- Hurt, E., Zulewska, J., Newbold, M. and Barbano, D.M. (2010) Micellar casein concentrate production with a 3x, 3-stage, uniform transmembrane pressure ceramic membrane process at 50°C, *J Dairy Sci*, **93**: 5588–5600.
- Jaffrin, M.Y. (2008) Dynamic shear-enhanced membrane filtration: A review of rotating disks, rotating membranes and vibrating systems, *J Membr Sci*, **324**: 7–25.
- James, B.J., Jing, Y. and Chen, X.D. (2003) Membrane fouling during filtration of milk – a microstructural study, *J Food Eng* **60**: 431–437.
- Jiménez-Flores, R. and Brisson, G. (2008) The milk fat globule membrane as an ingredient: why, how, when? *Dairy Sci Technol* **88**: 5–18.
- Jonsson, G. (1984) Boundary layer phenomena during ultrafiltration of dextran and whey protein solutions, *Desalination*, **51**: 61–77.
- Karasu, K., Glennon, N., Lawrence, N.D. *et al.* (2010) A comparison between ceramic and polymeric membrane systems for casein concentrate manufacture, *Int J Dairy Technol*, **63**: 284–289.

- Kromkamp, J., Rijnsent, S., Huttenhuis, R. *et al.* (2007) Differential analysis of deposition layers from micellar casein and milk fat globule suspensions onto ultrafiltration and microfiltration membranes, *J Food Engin*, **80**: 257–266.
- Kuhnl, W., Piry, A., Kaufman, V. *et al.* (2010) Impact of colloidal interactions on the flux in cross-flow microfiltration of milk at different pH values: A surface energy approach, *J Membr Sci*, **352**: 107–115.
- Lan, X.P., Wag, J.Q., Bu, D.P. *et al.* (2010) Effects of heating temperatures and addition of reconstituted milk on the heat indicators in milk, *J Food Sci*, **75**: C653–658.
- Lindquist, A. (2002) Method for producing sterile, stable milk, US Patent 6372276, Assignee Tetra Laval Holdings and Finance S.A.
- Liu, F., Hashim, N.A., Liu, Y. *et al.* (2011) Progress in the production and modification of PVDF membranes. Review, *J Membr Sci*, **375**: 1–27.
- Lopez, C., Briard-Bion, V., Ménard, O. *et al.* (2011) Fat globules selected from whole milk according to their size: Different compositions and structure of the biomembrane, revealing sphingomyelin-rich domains, *Food Chem*, **125**: 355–368.
- Lucey, J. (2012) Use filtration technology to produce functional beta-casein. Emerging Food R&D Report, Food Technology Intelligence, Midland Park, NJ.
- Lucey, J. and Smith, K. (2012) Separating milk into different value added fractions – What are the opportunities? 14th Annual Dairy Ingredients Symposium, 1–2 March 2012.
- Luo, J., Ding, L., Wan, Y. *et al.* (2012) Fouling behavior of dairy wastewater treatment by nanofiltration under shear-enhanced extreme hydraulic conditions, *Sep Purif Technol.*, **88**, 79–86.
- Ma, Y., Ryan, C., Barbano, D.M. *et al.* (2000) Effects of somatic cell count on quality and shelf-life of pasteurized fluid milk, *J Dairy Sci*, **83**: 264–274.
- Madec, M.N., Mejean, S. and Maubois, J.L. (1992) Retention of *Listeria* and *Salmonella* cells contaminating skim milk by tangential membrane microfiltration (“Bactocatch” process), *Lait*, **72**: 327–332.
- Malmberg, R. and Holm, S. (1988) Producing low bacteria skim milk by microfiltration, *North Eur Food Dairy J*, **1**: 75–78.
- Marshall, A.D., Munro, P.A. and Trägårdh, G. (1993) The effect of protein fouling in microfiltration and ultrafiltration on permeate flux, protein retention and selectivity: A literature review, *Desalination*, **91**: 65–108.
- Maubois, J.-L. (2011), Emerging technologies and innovation in milk processing, <http://simleite.com/home/palestras/simleite10.pdf>. (last accessed 27 December 2014).
- McCarthy, O.J. and Singh, H. (1993) Physico-chemical properties of milk. In: *Advanced Dairy Chemistry, Vol. 3, Lactose, Water, Salts and Minor Constituents* (eds P.L.H. McSweeney and P.F. Fox). Springer, New York, NY, p. 713.
- Membralox, (2002) Membralox Users Manual. Pall Corp, Port Washington, NY.
- Merin, U. and Daufin, G. 1990. Crossflow microfiltration in the dairy industry: state-of-the-art. *Lait*, **70**: 281–291.
- Michalski, M.C., Gassi, J.Y., Famelart, M.H. *et al.* (2003) The size of native milk fat globules affects physico-chemical and sensory properties of Camembert cheese, *Lait*, **83**: 131–143.
- Michalski, M.C., Leconte, N., Briard-Bion, V. *et al.* (2006) Microfiltration of raw whole milk to select fractions with different fat globule size distributions: Process optimization and analysis, *J Dairy Sci*, **89**: 3778–3790.
- Michalski, M.C., Camier, B., Gassi, J.-Y. *et al.* (2007) Functionality of smaller vs. control native milkfat globules in emmental cheeses manufactured with adapted technologies, *Food Res Int*, **40**: 191–202.

- Mirzaie, A. and Mohammadi, T. (2012) Effect of ultrasonic waves on flux enhancement in microfiltration of milk, *J Food Engin*, **108**: 77–86.
- Morin, P., Britten, M., Jiménez-Flores, R. and Pouliot, Y. (2007) Microfiltration of buttermilk and washed cream buttermilk for concentration of milk fat globule membrane components, *J Dairy Sci*, **90**: 2132–2140.
- Novak, J.S., Call, J.E., Tomasula, P.M. and Luchansky, J.B. (2005) An assessment of pasteurization treatment of water, media, and milk with respect to bacillus spores, *J Food Prot*, **68**: 751–757.
- Ollikainen, P., Muuronen, K. and Tikanmäki, R. (2012) Effect of pasteurization on the distribution of bovine milk transforming growth factor- β 2 in casein and whey fractions during micro- and ultrafiltration processes, *Int Dairy J*, **26**: 141–146.
- Pafylas, I., Cheryan, M. Mehaia, M.A. and Saglam, N. (1996) Microfiltration of milk with ceramic membranes, *Food Res Int*, **29**: 41–146.
- Pignon, F., Belina, G., Narayanan, T. *et al.* (2004) Structure and rheological behavior of casein micelle suspensions during ultrafiltration process, *J Chem Phys*, **121**: 8138–8146.
- Piry, A., Heino, A., Kuhn, W. *et al.* (2012) Effect of membrane length, membrane resistance, and filtration conditions on the fractionation of milk proteins by microfiltration, *J Dairy Sci*, **95**: 590–1602.
- Popovic, S. and Tekic, M.N. (2011) Twisted tapes as turbulence promoters in the microfiltration of milk, *J Membr Sci*, **384**: 97–106.
- Pouliot, Y. (2008) Membrane processes in dairy technology – From a simple idea to worldwide panacea, *Int Dairy J*, **18**: 735–740.
- Pouliot, Y. and Gauthier, S.F. (2006) Milk growth factors as health products: Some technological aspects, *Int Dairy J*, **6**: 1415–1420.
- Prádānos, P., de Abajo, J., de la Campa, J.G. and Hernández, A. (1995) A comparative analysis of flux limit models for ultrafiltration membranes, *J Membr Sci*, **108**: 129–142.
- Qu, P., Gesan-Guizou, G. and Bouchoux, A. (2012) Dead-end filtration of sponge-like colloids: The case of casein micelle, *J Membr Sci*, **417–418**: 10–19.
- Ripperger, S. and J. Altmann. (2002) Crossflow microfiltration – state of the art, *Sep Purif Technol*, **26**: 19–31.
- Rysstad, G. and Kolstad, J. (2006) Extended shelf life milk-advances in technology, *Int J Dairy Technol*, **59**: 85–96.
- Saboya, L.V. and Maubois, J.-L. (2000) Current developments of microfiltration technology in the dairy industry, *Lait*, **80**: 541–553.
- Saeman, A.I., Verdi, R.J., Galton, D.M. and Barbano, D.M. (1988) Effect of mastitis on proteolytic activity in bovine milk, *J Dairy Sci*, **71**: 505–512.
- Samuelsson, G., Huisman, I.H., Trägårdh, G. and Paulsson, M. (1997) Predicting limiting flux of skim milk in crossflow microfiltration, *J Membr Sci*, **129**: 277–281.
- Sandblom, R.M. 1978. Filtering process. Alfa-Laval AB, assignee. US Patent No. 4,105,547.
- Santos, M.V., Ma, Y., Caplan, Z., and Barbano, D.M. (2003) Sensory threshold of off-flavors caused by proteolysis and lipolysis in milk, *J Dairy Sci*, **86**: 1601–1607.
- Sauer, A. and C.I. Moraru. (2012) Heat stability of micellar casein concentrates as affected by temperature and pH, *J Dairy Sci*, **95**: 6339–6350.
- Schmidt, V.S., Kaufmann, V., Kulozik, U. *et al.* (2012) Microbial diversity, quality and shelf life of microfiltered and pasteurized extended shelf life (ESL) milk from Germany, Austria and Switzerland, *Int J Food Microbial*, **154**: 1–9.
- Schulz, G. and Ripperger, S. (1989) Concentration polarization in crossflow microfiltration, *J. Membr.Sci*, **40**: 173–187.

- Shi, J., Ahlroos-Lehmus, A., Pilvi, T.K. *et al.* (2012) Metabolic effects of a novel microfiltered native whey protein in diet-induced obese mice, *J Funct Foods*, **4**: 440–449.
- Singh, H. (2006) The milk fat globule membrane – A biophysical system for food applications, *Curr Opin Colloid Interface Sci*, **11**: 154–163.
- Skrzypek, M. and Burger, M. (2010) ISOFLUX ceramic membranes – Practical experiences in dairy industry, *Desalination*, **250**: 1095–1100.
- Spence, A.J., Jimenez-Flores, R., Qian, M. and Goddick, L. (2009a) The influence of temperature and pressure factors in supercritical fluid extraction for optimizing nonpolar lipid extraction from buttermilk powder, *J Dairy Sci*, **92**: 458–468.
- Spence, A.J., Jimenez-Flores, R., Qian, M. and Goddick, L. (2009b) Phospholipid enrichment in sweet and whey cream powders using supercritical fluid extraction, *J Dairy Sci*, **92**: 2373–2381.
- Spence, A.J., Jimenez-Flores, R., Qian, M. and Goddick, L. (2009c) Short communication: Evaluation of supercritical fluid extraction aids for optimum extraction of nonpolar lipids from buttermilk powder, *J Dairy Sci*, **92**: 5933–5936.
- Tavares, T.G., Amorim, M., Gomes, D. *et al.* (2012) Manufacture of bioactive peptide-rich concentrates from whey: Characterization of pilot process, *J Food Eng*, **110**: 547–552.
- te Giffel, M.C. and van der Horst, H.C. (2004) Comparison between bactofugation and microfiltration regarding efficiency of somatic cell and bacteria removal. *Bull Int Dairy Fed*, **389**, 49–53.
- Thoma, G., Popp, J., Nutter, D. *et al.* (2013) Greenhouse gas emissions from milk production and consumption in the United States: A cradle-to-grave life cycle assessment circa 2008, *Int Dairy J*, **31**: S3–S14.
- Tomasula, P.M. and D.W. Nutter. (2011) Mitigation of greenhouse gas emissions in the production of fluid milk, *Adv Food Nutr Res*, **62**: 41–88.
- Tomasula, P.M., Mukhopadhyay, S., Datta, N. *et al.* (2011) Pilot-scale crossflow-microfiltration and pasteurization to remove spores of *Bacillus anthracis* (Sterne) from milk, *J Dairy Sci*, **94**: 4277–4291.
- Tomasula, P.M., Yee, W.C.F., McAloon, A.J. *et al.* (2013) Computer simulation of energy use, greenhouse gas emissions, and process economics of the fluid milk process, *J Dairy Sci*, **96**: 3350–3368.
- Tomasula, P.M., Datta, N., Yee, W.C.F. *et al.* (2014) Computer simulation to predict energy use, greenhouse gas emissions and costs for production of fluid milk using alternative processing methods, *J. Dairy Sci*, **97**: 4594–4611.
- Trouv e, E., Maubois, J.L. Piot, M. *et al.* (1991) R etention de diff erentes esp eces microbiennes lors de l' epuration du lait par microfiltration en flux tangentiel, *Lait*, **71**: 1–13.
- van der Horst, H. C. and Hanemaaijer, J.H. (1990). Cross-flow microfiltration in the food industry. State of the Art, *Desalination*, **77**: 235–258.
- Van Hekken, D.L. and Holsinger, V.H. (2000) Use of cold microfiltration to produce unique beta-casein enriched milk gels, *Lait*, **80**: 69–76.
- Walkling-Ribiero, M., Rodr iguez-Gonz alez, O., Jayaram, S. and Griffiths, M.W. (2011) Microbial inactivation and shelf life comparison of 'cold' hurdle processing with pulsed electric fields and microfiltration, and conventional thermal pasteurization in skim milk. *Int J Food Microbiol*, **144**: 379–386.
- Whitaker, R., Sherman, J.M. and Sharp, P.F. (1927) Effect of temperature on the viscosity of skimmilk, *J Dairy Sci*, **10**: 361–371.

-
- Wijmans, J.G., Nakao, S. and Smolders, C.A. (1984) Flux limitation in ultrafiltration: osmotic pressure model and gel layer model, *J Membr Sci*, **20**: 115–124.
- Woychik, J.H., Cooke, P. and Lu, D. (1992) Microporous ultrafiltration of skim milk, *J. Food Sci.*, **57**: 46–48, 58.
- Zulewska, J., Newbold, M. and Barbano, D.M. (2009) Efficiency of serum protein removal from skim milk with ceramic and polymeric membranes at 50°C, *J. Dairy Sci*, **92**: 1361–1377.
- Zulewska, J. and Barbano, D.M. (2013) Influence of casein on flux and passage of serum proteins during microfiltration using polymeric spiral-wound membranes at 50°C, *J. Dairy Sci*, **96**: 2048–2060.

2

Novel Thermal Methods in Dairy Processing

Vijay K. Mishra and Lata Ramchandran

College of Health and Biomedicine, Victoria University, Australia

2.1 Introduction

Heating of milk is the oldest and the most common treatment of raw milk before it is deemed fit for human consumption or further processed into various products. Apart from making milk safe for consumption, heat treatment enhances the shelf life of milk by destroying spoilage microorganisms and enzymes and modifies functionality of the dairy ingredients. Heat treatment of milk in most countries legally requires that 'each and every particle of milk' must be heated to a specified temperature and time for it to be accepted as processed milk. Additionally, heating can impart physical and chemical changes that may or may not be desired. Heat energy is also used for a variety of other applications, which include concentration and drying of milk, assisting in whey separation in cheese making, improving viscosity and texture in yoghurt and ice cream making. The types of heat treatments and their application objectives in dairy processing are listed in Table 2.1. Steam or hot water supplies the energy required for the purpose of heating for various applications. Depending on the intensity of heat treatment, undesirable changes in milk and its constituents can adversely affect colour, flavour and nutritional value of milk and dairy products. These include browning, development of cooked or heated flavour, loss of vitamins and so on (Vasavada, 1990; Fu, 2004; Ahmed and Ramaswami, 2007; Ansari and Datta, 2007; Lima, 2007; Marra *et al.*, 2009).

Increased consumer awareness and demands for fresh products have pushed the dairy industry to explore and develop alternative heat processing techniques that not only ensure the safety of the product but also enhance shelf life, retain nutrients and maintain freshness and wholesomeness of the processed product. Improving the process efficiencies and economics are other drivers to these innovations. This has led to the emergence of alternative thermal technologies wherein rise in temperature in the product is mainly responsible for the processing effects as in conventional methods of

Table 2.1 Commonly used heat treatments in dairy processing

Heating process	Temperature (°C)	Time	Purpose	References
Thermization of milk	65	15 s	Destroy psychrotrophs and stabilise proteins	Vernam and Sutherland, 1996
Low temperature pasteurization	63–66	30 min	Destroy pathogens in milk and milk products	Chandan, 2008, Vernam and Sutherland, 1996
High temperature pasteurization	72–75 85	15–20 s 20 s–30 min	Destroy pathogens; inactivate enzymes in high viscosity products, e.g. cream	Chandan, 2008, Vernam and Sutherland, 1996
In bottle sterilization of milk	110–120	20–40 min	Destroy all pathogens and spoilage bacteria	Vernam and Sutherland, 1996
Ultra high temperature treatment	130 140–145	30 s 2–6 s	Destroy all pathogens and spoilage bacteria including spores	Chandan, 2008, Vernam and Sutherland, 1996
Ultra pasteurisation	137.8	2–4 s	Shelf life extension better than HTST	Chandan, 2008
Evaporation and concentration	45–54.6 (under vacuum)	Sufficient to increase given solid concentration	pasteurization Evaporation	Farkye, 2008
Sterilization of canned concentrated milk	115–121	15–20 min	Destroy bacterial spores, enzymes	Farkye, 2008
Preheating before evaporation for production of concentrated milk	93–100 or 115–128	10–25 min or 1–6 min	Reduction of microbial load, inactivate enzymes, stabilizing proteins, reduction of viscosity for evaporated and condensed milk production	Farkye, 2008

Heating before concentration for production of powder	72–120	15 sec to 30 min	Reduction of microbial load, inactivate enzymes, stabilizing proteins or controlled denaturation of proteins	Augustine and Clark, 2008; Vernam and Sutherland, 1996
Heating of milk concentrate in a spray dryer	70–95 (outlet) and 180–230 (inlet)	Few seconds	Drying	Vernam and Sutherland, 1996
Preheating of ice cream mix to assist in blending	45	Few minutes	To have smoother mix	Kilara and Chandan, 2008
Scalding of cheese curd	40	Sufficient to expel whey	Whey separation, final product moisture control and cheese body	Vernam and Sutherland, 1996
Heat treatment of milk for yoghurt	80	30 min	Improve viscosity and texture of yoghurt in addition to reduction in microbial load	Vernam and Sutherland, 1996

heating (Proctor, 2011). Electroheating methods have been key novel thermal processing technologies investigated with a view to substitute conventional heating in dairy processing. These are known as volumetric heating methods, as heat is generated within milk or milk products leading to rise in temperature, which contributes to the food preservation and processing effects. Examples of electroheating methods are ohmic (direct heating) and dielectric heating (indirect heating). Unlike ohmic heating, dielectric heating methods (microwave and radio frequency) involve, firstly, conversion of electrical energy to electromagnetic radiation, which interacts with the product components to generate heat. Direct heating (ohmic) involves direct conversion of electric energy to heat leading to high heating efficiencies. The major advantages of these technologies include:

- Rapid heating with minimal heat damage to the product.
- Reduction of process time resulting in increased productivity.
- Reduced operating costs due to better energy and heating efficiencies.
- Improved retention of nutrients.
- No requirement for heat-transfer surfaces, leading to reduced fouling of heating surfaces leading to sustained high performance efficiency of the system.
- Absence of overcooking of food in contact with heating surfaces.
- Better and simple process control and reduced maintenance costs.
- Clean and safe.
- Environmentally friendly.

This chapter focuses on ohmic, microwave (MW) and radio frequency (RF) heating methods in reference to their use in the preservation and processing of milk and milk products.

2.2 Ohmic Heating

Ohmic heating (OH), also known as electrical resistance heating or joule heating, was introduced for milk pasteurization early in the nineteenth century but the high processing costs and the short supply of inert materials for electrodes stunted its development. Renewed interest in this method during the last two decades has focused more on processing nondairy products such as fruit, vegetable and meat products. The inherent process advantages, such as uniformity of heating and rapid heating rates, improve the quality of products due to very little changes in textural, nutritional and organoleptic characteristics of the product (Parrot, 1992; Kim *et al.*, 1996; Lima, 2007; Vicente *et al.*, 2006, 2012).

Fouling of heat exchanges is a serious issue in dairy processing involving conventional heating. Bansal and Chen (2005) reviewed the mechanism involved in fouling of heat exchanges by dairy fluids. Inefficient heat transfer due to fouling of surface results in defects attributed to both under and overheating of dairy products, reduces the heat transfer efficiency and increases the pressure drop in the heat exchangers, leading to significantly increased cost associated with energy, lost productivity and impact on the environment when convention heating methods are used. Fouling is expected to be reduced in OH due to avoidance of limitation of low thermal conductivity, higher than 90% energy conversion efficiency and lower operating cost associated with equipment (Tham *et al.*, 2006).

2.2.1 Principles

Ohmic heating of products occurs through application of electric fields with a given electrical conductivity using electrodes that are in direct contact with the food. Passage of electrical current through fluids such as milk, with the fluid acting as electrical resistance, results in instantaneous rise in temperature that pasteurizes milk within seconds (Parrot, 1992; Vicente and Castro, 2007). Electrically conductive elements present in milk and milk products are generally water and salts. The passage of current through a conductive material follows Ohm's law (Voltage = Current \times Resistance) and the consequent heat generated ignoring the losses can be arrived at by:

$$Q = R * I^2 \quad (2.1)$$

where Q is the heat generated in dairy system, R is the electrical resistance of product and I is the current passing through the product.

Electric resistance of the product mainly determines how quickly heat is produced in addition to heat capacity and flow and residence time in the system.

Equation 2.2 is used to relate heat generation rate when fluid is heated:

$$\dot{u} = |\nabla V|^2 \sigma \quad (2.2)$$

where \dot{u} is the rate of energy generated for a given volume of the product, ∇V is the voltage gradient and σ is the electrical conductivity of the fluid. The fundamental principles and modelling of OH of foods have been covered in detail elsewhere (Sastry and Palaniappan, 1992; Palaniappan *et al.*, 1992; Ruan *et al.*, 2004; Vincente *et al.*, 2006; Lima, 2007; Vincente and Castro, 2007). The typical range of heat generated by applying 20 V/cm can range between 0.02 and 5 W/cm³ depending on the product (Datta and Hu, 1992).

2.2.2 Factors Affecting OH

The heating rate of food subjected to ohmic heating is influenced by a number of factors.

Electrical Conductivity of Food Electrical conductivity (EC) of foods can be determined using Equation 2.3 (Ruan *et al.*, 2004; Lima, 2007)

$$\sigma = \frac{l}{AR} \quad (2.3)$$

where σ is electrical conductivity (S/m), l the path length (m), A cross-sectional area (m²) and R the resistance (ohm). Milk has conductive properties due to charged compounds, particularly ions such as sodium, potassium and chlorides (Mabrook and Petty, 2003). Change in this property has also been used in the detection of bovine mastitis (Nielen *et al.*, 1992) due to changes in the composition. Electrical conductivity of cow's milk at 18°C is 4–6 mS/cm (Anon, 2013). Change in the acidity as a result of fermentation, the presence of ionizable components (salt content), temperature, state and composition, stage of lactation, season, feed and field strength affect EC and heating efficiency in OH (Sastry, 2005; Vincente and Castro, 2007). Electrical properties of foods relevant to OH, including some dairy products, have been reviewed elsewhere

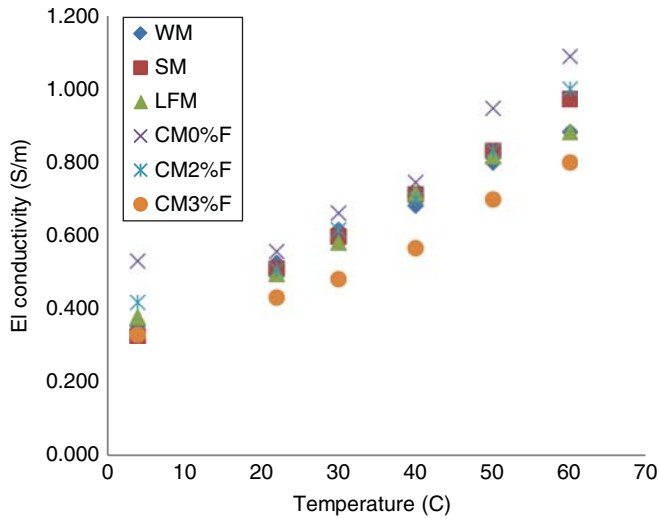

Figure 2.1 Effect of temperature on electrical conductivity of whole milk (WM), skimmed milk (SM), low fat milk (LFM) and chocolate milks (CM0%Fat, CM2%fat and CM3%fat). Data of Ruhlman *et al.* (2001) as cited by Sastry (2005).

(Sastry, 2005). The EC values for whole milk, reduced fat milk and chocolate milk are plotted in Figure 2.1 as a function of temperature using data from Ruhlman *et al.* (2001). Increase in temperature results in an increase in the EC. Fat content and other constituent cocoa solids suspended in chocolate milk affected conductivity. At constant temperature skimmed milk has higher conductance than whole milk (higher fat content). As observed by Mabrook and Petty (2003), ionic components of milk will mainly influence EC values of milk and milk products. Electrical conductivity of liquids including milk increases linearly with an increase in temperature and can be predicted with acceptable accuracy by:

$$\sigma_T = \sigma_r[1 + m(T - T_r)] \quad (2.4)$$

where σ_T and σ_r are electrical conductivities of the product at temperature (T) and a reference temperature, T_r , respectively, and m is the slope (Sastry and Palaniappan, 1992; Sastry, 2005) of the line between temperature and conductivity. Icier (2009) and Icier and Tavman (2006) presented experimental data on temperature effect on the EC electrical conductivity of whey solutions (8–24% solute) and ice cream mixes (Maras and standard). These authors presented their data in the form of Equation 2.5 and the fitted values of σ_0 and m for 20–80°C at various voltage ingredients and solute concentration were reported (Icier and Tavman, 2006; Icier, 2009).

$$\sigma = \sigma_0 + mT \quad (2.5)$$

Particle Orientation Characteristics The orientation of particles with respect to direction of the electric field influences the heating rate of the food. Heating is more effective when particles are parallel to the electric field. Similarly, presence of smaller

particle size in liquids results in faster heating of the samples (Vicente and Castro, 2007). However, particle geometry becomes relevant only when aspect ratio is greater than one for the solid particles.

Field Strength and Configuration of Heater Liquid heating time is reduced when the increased field strength or voltage gradient is applied (Icier, 2009). This is illustrated in the Figure 2.2. For examples, at constant solid concentration in whey solution, less time will be required to raise temperature at higher field strength (40 V/cm) than at low field strength (20 V/cm). The effect of field strength will also depend on solid concentration in a solution. For example, as the solid concentration increased in whey solution, the increasing effect of field strength on raising the temperature reduced significantly (Icier, 2009).

Heater geometries can influence both the rate and uniformity of heating significantly. Both continuous and static types of configurations for OH of fluids have been used and investigated (Sastry and Palaniappan, 1992, Vicente *et al.*, 2006, 2012). The system consists of bank of electrodes connected together and housed in an insulating chamber. The distance between the electrodes and dimensions will also influence heating. Product can flow upwards or downwards in a continuous flow system, which will cause agitation effects. The effect of the geometries will influence electrical parameters (current and voltage). Out of the two geometries (parallel or cross), it has been found that application of an electrical field at a right angle to the fluid flow (cross-filled) is more suitable to heating dairy fluids to assure uniform heating (Tham *et al.*, 2006). The type of electrode, number and its surface also influence heating. Besides the level of corrosion, material used for electrodes show differences in heating and fouling behaviours (Ayyadi *et al.*, 2004; Samaranayake and Sastry, 2005; Standl and Zitney, 2010). Graphite electrodes have been found to be superior to both stainless steel and

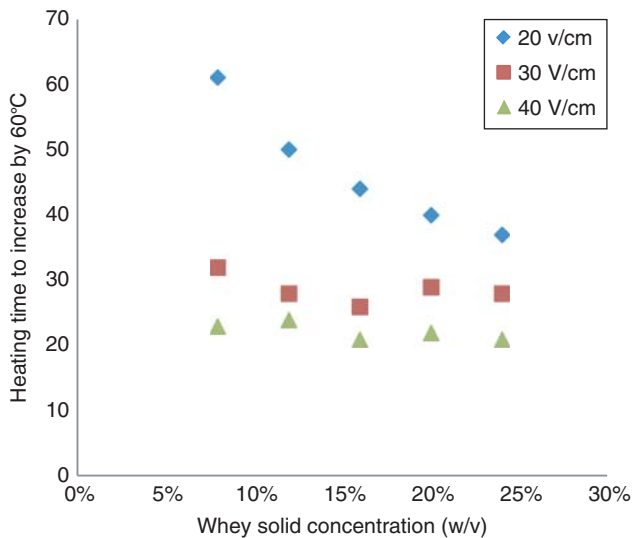

Figure 2.2 Effect of voltage gradient (V/cm) and whey solid concentration on the heating time required to reach a temperature difference of 60°C (from 20 to 80°C). Data from Icier (2009).

tin electrodes due to their less susceptibility to foul and enhance the heating characteristics of milk (Stancl and Zitney, 2010). Very little information is available on the effect of frequency, which is known to affect EC and, therefore, heating.

Product Characteristics Milk and milk products are composed of varied concentrations of water, proteins, fat, carbohydrates (lactose) and minerals. Heating effects are mainly influenced by the relative influence on the electrical conductivity and voltage gradient. The higher the fat content is, the lower will be the rate of heating as explained above. From the viewpoint of composition, water and ionic components will be the key contributors in rise in temperature. Heat generation will also depend on the specific heat capacity, viscosity and density of each of the components present in a given dairy formulation. Thermal conductivity will influence heating only when formulation is not homogenous. Formulation where solid particles are present in the liquid will also heat differently, as shown by Sastry and Palaniappan (1992).

2.2.3 Applications and Influence of OH on Dairy Product Quality

Due to the higher heat conversion efficiency of OH, it is possible to achieve high temperature in a very short time compared to conventional heating. Heating rates of 8–40°C/s are possible for dairy products (Tham *et al.*, 2006). It has been found to provide distinct advantages for heating liquids containing particulates. Commercial applications of OH have mainly been in thermal processing of nondairy foods, such as tomato-based sauces, whole liquid egg, fish paste and meat products. Use of OH in dairy processing are listed with perceived advantages of the treatment in Table 2.2.

Anderson and Finkelstein (1919) and Getchell (1935) reported the use of electricity in pasteurization of milk. The milk was heated to 72°C and held at this temperature for 15 seconds, similar to conditions used in high temperature, short time (HTST) conventional pasteurization (Getchell, 1935) using a 15 kW AC current at 220 V. This process was discontinued due mainly to the high cost of electricity and poor quality of electrodes employed. The Electropure Process for milk pasteurization using OH was commercialized in 1938 in the United States of America; it did not achieve much commercial success thereafter. A pilot study was conducted by a consortium of food processors, equipment manufacturers, ingredient suppliers, academia and the government in the United Kingdom to evaluate the application of a 5 kW continuous flow ohmic system to develop shelf stable products such as cheese. The study concluded that the technology was technically and economically viable for enhancing quality of food products (Parrot, 1992). Ruan *et al.* (2004) predicted that developments in electrode and equipment design may increase application of OH for processing milk.

OH has been specifically used for heating foods with non-Newtonian rheological properties, such as highly viscous ice cream mixes (Icier and Tavman, 2006) and whey protein solutions with concentrations up to 25% (Icier, 2009). Applying six different voltage gradients (10–60 V/cm) to standard ice cream mixes (9.8% fat, 63.3% water, 23.4% carbohydrates, 3.4% protein and 0.1% ash) and Maras ice cream (3.3% fat, water 66%, 26.7% carbohydrates, 2.6% protein and 1.4% ash), Icier and Tavman (2006) confirmed that heating time for both mixes reduced as applied voltage gradient increased in the range of 10–60 V/cm. Within this range of applied voltage gradient, heating times required for raising the mix temperature from 4 to 80°C for Maras-type

Table 2.2 Applications and advantages of ohmic heating in dairy processes

Processing applications	Advantages	References
Pasteurization of milk	Improved quality	Anderson and Finkelstein, 1919 Getchell, 1935
Heating of whey solutions	Improved temperature sensitivity of whey proteins and handling of shear sensitive products	Icier, 2009
Heating of ice cream mixes	Heating of ice cream mixes	Icier and Tavman, 2006
Heat treatment of milk	Inactivation of microorganisms and reduced protein denaturation	Sun <i>et al.</i> , 2008
Alternative pasteurization	Inactivation of milk enzymes, alkaline phosphatase	Castro <i>et al.</i> , 2004
Heat inactivation of bacteria and yeast	Improved quality	Mainville <i>et al.</i> , 2001
Heat treatment of whole, skimmed milk and low fat milk	Avoid fouling and heat induced damage to milk	Ayadi, <i>et al.</i> , 2003 Bansal and Chen, 2006 Tham <i>et al.</i> , 2006, 2009 Stancl and Zitny, 2010
Pasteurization of goat milk	Avoiding rancidity due to development of free fatty acids	Pereira <i>et al.</i> , 2008

ice cream mix was significantly lower than for standard ice cream mixes. This was attributed to compositional differences, particularly higher fat and ash contents in standard ice cream mixtures. Maras-type ice cream mix was more sensitive to voltage gradient changes than normal ice cream. Icier (2009) also predicted the possible use of OH in whey processing where heating is required based on the observation that whey protein solutions (8–24% w/v solute concentration) were less sensitive to temperature changes than when using conventional heating, which is known to induce denaturation of proteins, reducing their value as functional ingredients. Strong and negative correlation was found between the consistency coefficients of the whey solutions and electrical conductivity during OH (Icier, 2009).

The effect of OH in reducing viable microbial cell counts in kefir without altering the structure of the product was studied using static heating system (Mainville, *et al.*, 2001) applying 150 V to raise temperature to 50, 60 and 72°C. These temperatures were maintained for 10 seconds and compared with other treatments, including conventional heating by autoclaving, at 110°C for 3 minutes. The treatment was effective at 72°C for inactivation of both yeasts and lactobacilli. However, both heat treatments caused significant microstructural changes in proteins and lipids.

Limited studies have been conducted on the aspect of quality of milk and milk products treated by ohmic heating. Fouling of the heating surface has been a major disadvantage in processing of milk where heat exchangers are used for heating of milk for pasteurization and sterilization. OH is expected to reduce fouling due to the absence of a heating surface and the rapid rise in temperature. The comparative advantage of lower temperature than the bulk temperature of milk during OH is expected to

reduce the fouling encountered during conventional surface heating. This has led to series of studies to investigate the fouling under OH of milk and milk products (De Alwis *et al.*, 1990; Ayadi *et al.*, 2004, 2005; Bansal and Chen, 2006; Tham *et al.*, 2009; Stancl and Zitny, 2010). However, Bansal and Chen (2006) found that this advantage cannot be sustained for a long period of time, as deposition on the electrode and overheating induces fouling. This is dependent on the frequency of the power supply and temperature. The electrode corrosion and subsequent fouling was found to be lower at 10 kHz than at 50 Hz, leading to less fouling. Hence, use of higher frequency is recommended. Increase in temperature during OH of milk has an effect on denaturation and aggregation of proteins as Ayadi *et al.* (2004) found that heating of whey protein based model fluid in a continuous OH system developed significant fouling on the electrodes with reduced heating performance of the system, as noted by increased current usage over 4–6 hours. Key performance indicators, pressure drop and rise in temperature increased during fouling development. A boiling temperature (135°C at 3 bar) was reached at the end of the experimental run, with significant deposition on the electrodes decreasing the heating performance. Vicente *et al.* (2012) predicted applications in reducing protein denaturation in dairy products by OH. For example, based on measurement of FAST (Fluorescence of advanced Maillard products and soluble tryptophane) indices, Sun *et al.* (2008) concluded that there was no significant differences in protein denaturation between OH and conventional heating of milk. The effect of OH on inactivation of food enzymes, including alkaline phosphatase and β -galactosidase, relevant to dairy applications were reported by Castro *et al.* (2004). Pereira *et al.* (2008) did not find hydrolysis of lipids in goat milk, as there was no difference in the free fatty acid contents upon pasteurization at 72°C for 15 seconds by either conventional heat or OH (14.4 V/cm of voltage gradient).

2.3 Microwave Heating (MWH) and Radio Frequency Heating (RFH)

Microwave ovens, introduced in 1947, are common household appliances in most countries worldwide. Application of microwave heating for food processing applications, such as cooking, pasteurization, sterilization and drying has been reviewed recently (Chandrasekaran *et al.*, 2013) and covered in several books (Datta and Ananatheswaran, 2001; Schubert and Regier, 2005; Tewari and Juneja, 2007; Sumnu and Sahin, 2012). Similarly, radio frequency heating in food applications have been reviewed by Marra *et al.* (2009), Vicente and Castro (2007), Zhao (2006) and Zhao and Ling (2012). MWH has become the most studied thermal technology as an alternative to conventional dairy heating processes for extending the shelf life of milk and milk products (Salazer-Gonzalez *et al.*, 2011). Unlike OH, MWH does not require any electrode for generating heat in the foods to be processed and a typical heat generation rate at 20 V/m can be as high as 1–16 W/cm³ (Datta and Hu, 1992).

Radio frequency heating involves the use of electromagnetic waves at frequencies lower than microwave frequencies and longer wavelength that ensures better penetration of these waves in foods than microwaves (Marra *et al.*, 2009). This system is also reportedly easier to build than MWH systems (Rowley, 2000). Reports on the use of RFH systems date back to the 1940s, with claims of providing foods with better quality than conventionally heated foods (Zhao and Ling, 2012).

Table 2.3 Characteristics of electromagnetic spectra

Type	Wavelength (A)	Frequency (Hz)
Radio	$>10^9$	$<3 \times 10^9$
Microwave	10^9-10^6	$3 \times 10^9-3 \times 10^{12}$
Infrared	10^6-7000	$3 \times 10^{12}-4.3 \times 10^{14}$
Visible	$7000-4000$	$4.3 \times 10^{14}-7.5 \times 10^{14}$
Ultraviolet	$4000-10$	$7.5 \times 10^{14}-3 \times 10^{17}$
X-ray	$10-0.1$	$3 \times 10^{17}-3 \times 10^{19}$
Gamma rays	<0.1	$>3 \times 10^{19}$

2.3.1 Principles

Microwaves (MW) and radio waves (RW) are a form of electromagnetic radiation. Table 2.3 provides characteristics of electromagnetic spectra in terms of wavelength and frequencies. The wavelengths of MW and RW are 10^9-10^6 A and $>10^9$, respectively. Frequencies of MW and RW are $3 \times 10^9-3 \times 10^{12}$ Hz and RW 3×10^9 Hz, respectively. Frequencies used for processing applications have been restricted and only selected frequencies are allowed for heating applications, as is discussed below (Piyasena *et al.*, 2003; FDA, 2000; Awuah *et al.*, 2007). Zhao and Ling (2012) summed up the differences in various electromagnetic-based methods used for heating.

Microwaves and radio waves are generated by magnetron or klystron and triode valve via electrodes, respectively (Marra *et al.*, 2009). These radiations can penetrate through the food systems and interact with food components to generate heat within the food that is commonly known as volumetric heating. This results in high energy efficiency and lower heating times (Fu, 2004; Zhu *et al.*, 2007). The two key mechanisms involved in microwave and radio frequency heating are dielectric and ionic interactions. However, in RF frequency ranges, dissolved ions are more important contributors to heating than water dipoles (Marra *et al.*, 2009). Most dairy foods have water as a key component acting as a dipole. The dipolar rotation of water is mainly responsible for dielectric heating wherein high frequency oscillation of water molecules under the influence of an oscillatory electromagnetic field generates heat due to intense friction. Higher values of the loss factor indicate a higher rate of heating. The heat thus generated is further propagated by conduction and convection (Salazar-Gonzalez, 2012). Additionally, the presence of ions in food, such as sodium and chloride, results in ionic conduction or ionic drifting due to oscillatory migration under the influence of microwave radiations causing ionic polarization, which results in multiple collisions and disruption of hydrogen bonds that also generate heat (Vincente and Castro, 2007; Marra *et al.*, 2009; Salazar-Gonzalez, 2012).

Two key mechanisms that influence dielectric heating of foods are dipolar and ionic interactions with food products (Buffer, 1993; Ohlsson and Bengtson, 2001). Volumetric heat generation in food by MW and RFW can be estimated using Equation 2.6 (Buffer 1993; Datta and Ananteswaran, 2001; Ohlsson, and Bengtson, 2001):

$$P = 2\pi f \epsilon_0 \epsilon'' E^2 \quad (2.6)$$

where P is rate of heat generated for a given volume (W/m^3), f is frequency, ϵ_0 and ϵ'' are permittivities of the free space and dielectric loss factor of product, respectively, and E is electrical field strength (V/m). This equation is valid for a particular

location and, therefore, has limitations in its practical applications (Vicente and Castro, 2007). Yet it provides a basis for relating the influence of system (frequency and electrical field strength) and material parameters (dielectric loss factor) on the power generation under dielectric heating. For a given energy input, lower field strength is required at higher frequencies. Another important aspect that needs consideration is the penetration depth of the waves that would interact with the dielectric components (water) to produce heat, which will eventually dissipate within dairy product depending on the thermal properties. Penetration depth of power can be estimated using Equation 2.7 for pumpable fluid material including milk (Coronel, *et al.*, 2003; Kumar *et al.*, 2007):

$$\delta_p = \frac{\lambda}{2\pi\sqrt{\left[2\epsilon' \left[\sqrt{1 + \left(\frac{\epsilon''}{\epsilon'}\right)^2} - 1\right]\right]}} \quad (2.7)$$

where δ_p is power penetration depth in meters corresponding to power drop of e^{-1} (37% of the incident) from the surface value, λ is the wave length, ϵ'' and ϵ' are relative dielectric loss and dielectric constant, respectively. This equation can be used for calculation of tube dimensions for continuous flow MWH systems for pasteurization and serialization of fluids. Penetration depth is low at high frequencies. For dielectric loss factors >25 , the depth can range between 0.6 and 1 cm (Venkatesh and Raghavan, 2004; Sosa-Morales, 2010). The penetration depth is about 10 times higher at 915 MHz than at 2450 MHz for water. RF will have even higher penetration depths.

2.3.2 Factors Affecting MWH and RFH

It is generally understood that the nonuniform heat generated by microwaves can create temperature gradients within the product that, in turn, could alter the volumetric heat generation itself. The major factors affecting the effectiveness of heating can be classified as those related to the system (e.g. frequency) and the product that is targeted for heating. These factors can influence heating by acting synergistically or antagonistically, as follows.

Frequency The selection of the frequency of microwave for heating food is important as it affects the dielectric characteristics and the depth of penetration by the radiations. In general, the lower the frequency the greater is the depth of penetration (Fu, 2004; Datta *et al.*, 2005; Salazar-Gonzalez, 2012; Sosa-Morales *et al.*, 2010). Due to lower frequencies, RW penetrate more than MW and, therefore, are preferred for solids. It follows that for large samples low frequency microwave radiations would be the most effective. The permitted frequencies of MW and RF waves for food processing are 915 and 2450 MHz and 13.56, 27.12 and 40.68 MHz, respectively (Piyasena *et al.*, 2003; FDA, 2000; Awuah *et al.*, 2007), although depending on the heating temperatures, frequencies up to 150 MHz in RF heating are also used. Typically, frequencies of 2450 MHz are commonly used for penetration depths of 0.6–10 cm, but frequencies of 915 MHz are legally permitted in the USA and Australia for industrial applications (Fu, 2004). Since only few frequencies are reserved for industrial heating

applications of food and dairy products, applications and associated theoretical treatments reported are limited to only these frequencies.

Composition The composition of milk and milk products depends on several factors and changes with type of milk, lactation, season, breed and feeding practices. Composition changes during various stages of processing as well as the different heating behaviours need to be accounted for. Rise in temperature will be dependent on the dielectric properties (dielectric constant and loss factor), which, in turn, depend on the composition. Dielectric properties of some dairy products are given in Table 2.4 at 20°C for, mainly, 2450 MHz and 915 MHz frequencies. Dielectric constant and the loss factor represent the ability of the dairy product to store energy and dissipate it as heat, respectively, when subjected to dielectric heating. Heat generated during dielectric heating is dependent on the amount of water, fat, protein and minerals present in a product. The most important dielectric components present in food are free water, salts and proteins (Datta *et al.*, 1995, 2005; Mudgett, 1995; Datta and Antheswaran, 2001; Vincente and Castro, 2007). As the amount of free water increases, dielectric constant and loss factor also increase. For foods containing a moisture content in the range 20–30%, the amount of heat generated increases with the increase in the moisture content. Contribution of fat to heat generation is relatively minimal. In a MW environment for a similar system, milk heats at a faster rate than water due to the presence of proteins and ionic components in the milk (Kudra *et al.*, 1991). The presence of salt in butter influences the dielectric properties (Ahmed *et al.*, 2007). For constant temperature and moisture conditions, an increase in salt content in butter gradually decreased ϵ' and penetration depth, and increased ϵ'' (Ahmed *et al.*, 2007). Most significantly, the presence of salt not only reduced the penetration depth of microwaves at both 915 and 2450 MHz frequencies but the differences due to frequencies were also narrowed down (Ahmed *et al.*, 2007). The mechanism of the effect of salt on the dielectric properties of foods systems containing water has been explained by Mudgett (1995). Ahmed and Luciano (2009) showed that dielectric properties of β -lactoglobulin dispersion were significantly influenced by the concentration and temperature. Both dielectric constant and loss factor increased at the denaturation temperature of 80°C.

Prediction of dielectric properties based on composition has been reviewed by several researchers (Calay *et al.*, 1995; Datta *et al.*, 1995; Mudgett, 1995). A comprehensive discussion of dielectric properties and their relevance for dielectric heating of foods has been provided by Chandrasekaran *et al.* (2013), Marra *et al.* (2009), Meda *et al.* (2005), Sosa-Morel *et al.* (2010), Tang (2005) and Venkatesh and Raghavan (2004) and covered in books written on microwave processing of foods specifically (Decareau 1985; Buffler 1993; Datta and Anantheshwaran, 2001; Schubert and Regier, 2005). These properties enable the processor to estimate heat generation, as described in Section 2.3.1.

Temperature The temperature of the food changes during microwave and radio frequency heating, which, in turn, influences the dielectric properties and, thereby, the efficiency of heating. Typically, increase in temperature reduces the dielectric constant and increases the loss factor, as demonstrated for 1.5% milk heated at a frequency of 915 MHz in Figure 2.3. Kumar *et al.* (2007) fitted dielectric experimental data as a function of temperature at 915 MHz for static and continuous flow conditions

Table 2.4 Dielectric properties of dairy products relevant to microwave heating at 20°C

Frequency (MHz)	Product	Dielectric constant	Dielectric loss	References
2450	Milk (1% fat)	70.6	17.6	Kudra <i>et al.</i> , 1992
	Milk (3.25% fat)	68	17.6	Kudra <i>et al.</i> , 1992
	Lactose solution in water (4%)	78.2	13.8	Kudra <i>et al.</i> , 1992
	Lactose solution in water (7%)	77.3	14.4	Kudra <i>et al.</i> , 1992
	Lactose solution in water (10%)	76.3	14.9	Kudra <i>et al.</i> , 1992
	Sodium caseinate solution in water (3.33%)	74.6	15.5	Kudra <i>et al.</i> , 1992
	Sodium caseinate solution in water (6.48%)	73	15.7	Kudra <i>et al.</i> , 1992
	Sodium caseinate solution in water (8.71%)	71.4	15.9	Kudra <i>et al.</i> , 1992
	Lactose	1.9	0	Kudra <i>et al.</i> , 1992
	Sodium caseinate	1.6	0	Kudra <i>et al.</i> , 1992
	Milk fat	2.6	0.2	Kudra <i>et al.</i> , 1992
	Process cheese (no fat)	43	43	Datta, 2005
	Process cheese (12% fat)	30	32	Datta, 2005
	Process cheese (24% fat)	20	22	Datta, 2005
	Process cheese (36% fat)	14	13	Datta, 2005
	915	Skim milk (0% fat)	66.5	15.1
Milk (1.5 % fat)		68.7	15.8	Coronel <i>et al.</i> , 2003
Milk (4% fat)		68.9	15.5	Coronel <i>et al.</i> , 2003
Chocolate milk (1.5% fat)		66.5	16.9	Coronel <i>et al.</i> , 2003
915	Whey protein gel	59.0	34.8	Wang <i>et al.</i> , 2003a
	Liquid whey protein mixture	61.6	33.5	Wang <i>et al.</i> , 2003a
1800	Whey protein gel	57.2	23.3	Wang <i>et al.</i> , 2003a
	Liquid whey protein mixture	58.9	23.1	Wang <i>et al.</i> , 2003a
915	Cheese sauce	42.9	46.2	Wang <i>et al.</i> , 2003a
1800	Cheese sauce	39.4	27.9	Wang <i>et al.</i> , 2003a
915	Unsalted butter*	25.6	4.9	Ahmed <i>et al.</i> , 2007
	Butter*	12.5	36.4	Ahmed <i>et al.</i> , 2007
2450	Unsalted butter*	24.5	4.3	Ahmed <i>et al.</i> , 2007
	Butter*	9.0	15.5	Ahmed <i>et al.</i> , 2007
2450	Whey powder (3% water)	1.93	0.017	Rzepecka and Pereira, 1974
915	β -lactoglobulin (5%)	59.9	4.6	Ahmed and Luciano, 2009
	β -lactoglobulin (10%)	44.3	4.0	
	β -lactoglobulin (15%)	61.6	8.0	
2450	β -lactoglobulin (5%)	58.4	8.4	Ahmed and Luciano, 2009
	β -lactoglobulin (10%)	43.7	6.8	
	β -lactoglobulin (15%)	62.3	10.0	

*Data are for 30°C

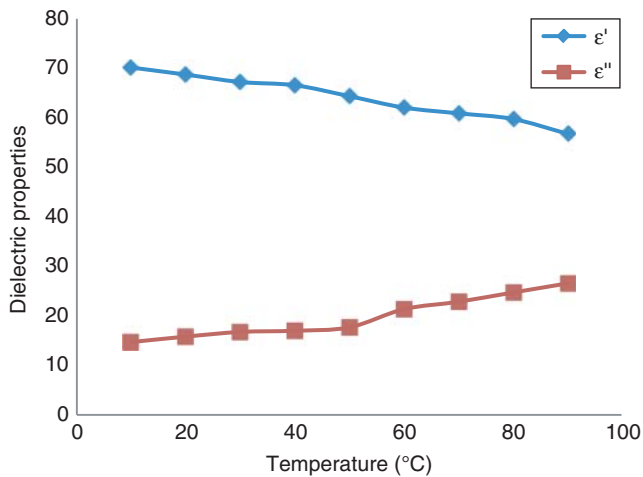

Figure 2.3 Effect of temperature on dielectric constant (ϵ') and loss factor (ϵ'') of 1.5% fat milk at 915 MHz (data of Coronel *et al.*, 2003).

for skimmed milk as a second order polynomial with high correlation coefficients ($r^2 \geq 0.903$). The rise in temperature in different products with similar dielectric properties has been reported to be identical (Coronel *et al.*, 2003) at constant frequency and similar power input. The penetration depth reduces as temperature increases (Vasavada, 1990; Ahmed *et al.*, 2007; Vincente and Castro, 2007; Ahmed and Luciano, 2009). This means that heat generation during dielectric heating will be dependent on temperature. Using whey proteins gel and liquid whey protein mixture, Wang *et al.* (2003a) showed significant changes in dielectric constant, loss factor and penetration depths as a function of temperature (20–121.1°C in the frequency range 27–2450 MHz) and proposed that, at MW frequencies, the likelihood of runaway heating would be minimal. In a later study, there was no difference reported for homogenous products such as skimmed milk for temperatures between 20 and 120°C (Kumar *et al.*, 2007).

Product Parameters other than Composition The mass, density and geometry of the sample influence the microwave and radio wave power input and wavelength for efficient heating. The density is positively correlated to the dielectric constant of the food and, therefore, its heating rate (Vincente and Castro, 2007). Power absorption is very much related to the volume of the product being heated (Mudgett, 1986; Buffler, 1993). Moreover, irregularity of shape results in uneven heating, a well known problem in MWH (Vasavada, 1990; Salazar-Gonzalez *et al.*, 2012), particularly with solids with edges.

Specific heat, electrical and thermal conductivities, and viscosity of product affect heating. Products having low values of specific heat can heat up faster. For example, milk fat heats up at a faster rate due to its significantly lower specific heat than rest of the milk components, despite of its small contribution to dielectric properties (Table 2.4). In contrast, high values of ionic conductivity increase the heating rate. It has been consistently demonstrated that the presence of ionic components and proteins in milk, show higher rates of heating than water under both MW and RF

heating (Kudra *et al.*, 1991; Awuah *et al.*, 2007). However, an increased ionic content of milk due to increased acidity may not contribute to an increase in heat generation due to a reduction in the penetration of electromagnetic radiation (Firouzi, *et al.*, 2005). Changes in these properties during heating have a pronounced effect on radio and microwave heating. As the temperature of the food increases during processing, the dielectric properties including the depth of penetration change with temperature. Change in phase during heating will affect both heating rates as well as the uniformity of heating (Vincente and Castro, 2007). The effect of phase change during melting of butter on heating has been reported (Ahmed *et al.*, 2007).

Heating System and Flow Conditions System configuration (oven) and its characteristics influence both the rate and pattern of heating. The capacity of the magnetron, cavity of the oven, position of placement and so on are key variables that will affect the rise in temperature for a known volume of product subjected to heating. A power test is normally employed to indicate how much power falls on a given volume of product. The effects of these have been discussed in several publications (Decareau, 1985; Buffer, 1993; Datta and Anantheshwaran, 2001; Housova and Hoke, 2002). Assessment of heating rate and nonuniform heating in ovens has also been investigated (Pitchai *et al.*, 2012) and reviewed (Vadivambal and Jayas, 2010).

Dielectric heating in batch and continuous flow conditions has resulted in different heating results due to differences in the temperature profile (Kudra *et al.*, 1991; Koutchma *et al.*, 2001; Kumar *et al.*, 2007; Villamiel *et al.*, 2009; Lin and Ramaswamy, 2011), which depends on the interactions between sample heated, electromagnetic field and whether the material is static or flowing. In studies involving a normal household oven, there was no flow involved and this affected the temperature rise and profile. Flow conditions (laminar versus turbulent) also affect uniformity of heating. Continuous flow systems have been more efficient than batch systems due to better heat generation and distribution (Villamiel *et al.*, 2009). For a constant level of power use, the higher is the flow rate the lower will be the magnitude of increase in temperature as reported by several researchers (Kudra *et al.*, 1991; Koutchma *et al.*, 2001; Coronel *et al.*, 2003; Villamiel *et al.*, 2009). Kumar *et al.* (2007), therefore, recommended that food dielectric properties measured under continuous flow conditions should be preferably used for designing continuous flow systems for multiphase systems.

2.3.3 Applications and Influence on Quality of Milk and Milk Products

Microwaves are commonly used for heating, precooking, tempering, blanching, pasteurization, sterilization, drying, thawing, and freeze-drying of foods (Vincente and Castro, 2007). Table 2.5 lists applications of both MW and RFH in dairy processing. Most applications reported are results of research investigations. The use of MW in pasteurization and sterilization is not new. Milk pasteurization either in batch mode by using conventional MW oven or using continuous flow systems with hold up time to attain desired sterility has been reported for number of years (FDA, 2000). Both MWH and RFH have been found capable of pasteurization of milk as these technologies inactivate phosphatase enzyme in milk, which is required in many countries as a check for adequacy of pasteurization. An advantage of using MWH in a

Table 2.5 Applications and advantages of microwave and radio frequency heating in dairy processes

Processing applications	Advantages	References
Microwave heating		
Thawing to improve concentration efficiency	Reduced time of thawing, and rapid concentration of whey	Aider <i>et al.</i> , 2008
Continuous pasteurization of milk	Safety, retention of nutritional quality Reduced time of thermal treatment Extended shelf life Improved sensory attributes Reduced denaturation of whey proteins Reduced loss of vitamins Improved safety	Albert <i>et al.</i> , 2009 Chiu <i>et al.</i> , 1984 Chiu <i>et al.</i> , 1984; Lopez-Fandino <i>et al.</i> , 1996; Villamiel <i>et al.</i> , 1996; Ansari and Datta, 2007 Villamiel <i>et al.</i> , 1996; Sierra <i>et al.</i> , 1999; Sierra and Vidal-Valverde, 2000 Korzynski <i>et al.</i> , 2013 Clare <i>et al.</i> , 2005
Sterilization of milk similar to conditions used in UHT	No off-flavour development during storage	
Freeze-drying of skim milk	Rapid drying	Wang and Guohua, 2005
Freeze-drying of foamed milk	Rapid drying and improved quality	Souda, <i>et al.</i> , 1989, Sochanski <i>et al.</i> , 1990
Surface pasteurization of Indian soft cheese (paneer)	Extended shelf life	Uprit and Mishra, 2004
Surface treatment of cottage cheese	Extended shelf life	Herve <i>et al.</i> , 1998
In-package heat treatment of cottage cheese and Camembert cheese	Process convenience, extended shelf life and quality improvement	Tochman <i>et al.</i> , 1985, Stehle, 1980
Post-process pasteurization of yogurt	Extended shelf life	Sarkar, 2006
Heating products filled with ice cream fillings	Prevents melting of ice cream in sandwiches and in pastry products	Sato, 2009, Michael, 2009
Stretching of pasta filata curd	Efficient recuperation of solids and reduction of residual enzymes in the curd	Isse and Savoie, 2008
Expansion of imitation cheese	Attain crispness	Arimi <i>et al.</i> , 2008a, 2008b, 2012; O'Riordan <i>et al.</i> , 2009
Gelation of whey protein	Difference in gel structure	Gustaw and Mleko, 2007
Heating of infant formula based on whey proteins	Reduce Maillard browning products	Laguerre <i>et al.</i> , 2011
Radio frequency heating		
Pasteurization of milk	Reduction of time of heating, improved quality	Awuah <i>et al.</i> , 2005
Sterilization of macaroni and cheese	Improve quality	Wang <i>et al.</i> , 2003b

continuous mode has been clearly demonstrated in achieving equivalent lethality in much less time than conventional pasteurization and uniformity of heating, therefore contributing to improvement of overall quality of milk. In addition to reaching the desired microbial protection, pasteurization of milk by MW showed increased shelf life of milk over conventional pasteurized milk (Chiu *et al.*, 1984) due to destruction of psychrotrophic bacteria. At the time of writing, there appears to be no commercial use of MW or RF for pasteurization of milk. In the following paragraphs, various applications that were investigated at research level are described.

Use of MW for sterilization of milk was reported by Clare *et al.* (2005) with an objective to compare its effectiveness with conventional UHT processing, where indirect steam was used to achieve the desired sterility. They applied microwaves (915 MHz, 60 kW system) to achieve high temperature (137.8°C for 10 s), similar to conditions used in UHT processing of skimmed and chocolate milks. For similar lethality, these authors found that MWH treatment was feasible and could replace conventional UHT processing in future.

Microwave heating treatment can also be applied for increasing the shelf life of pasteurized milk and milk products (Chiu *et al.*, 1984; Villamiel *et al.*, 1996). This approach was reported by Uprit and Mishra (2004) to increase the shelf life of paneer from 9 to 18 days by short MW treatment (120 W for 1 min). Languerre *et al.* (2011) concluded that MWH can be used for sterilization of infant foods and retention of nutritional quality of infant foods similar to UHT treatment. They suggested use of higher MW power for shorter time for best outcome.

Tochman *et al.* (1985) used two levels of MW powers (0.5 and 2.8 kW) for in-package heating of cottage cheese packaged in polystyrene and polypropylene tubs and flexible pouches to raise the temperature from 37 to 82.2°C. A low power source at 48.8°C yielded optimum quality of cheese.

Cryo-concentration is a method involving freezing of water from the solution followed by separation of concentrate. Aider *et al.* (2008) compared gravitational and microwave assisted thawing of frozen solution to prepare whey concentrate. Microwave assisted thawing provided similar efficiencies as the gravitational method, with advantages of being rapid and giving solids of higher purity in the concentrate.

Differential heating effects of MW have been used in the development of various unique products using dairy ingredients. Sato (2009) patented a method wherein a frozen ice cream sandwich was heated in a MW oven to thaw bread without melting of ice cream by separating the two with special sheets that were meant to be discarded before serving. A similar concept was used in a patent by Michael (2009), who described a process for production of frozen pastry products containing ice cream. Isse and Savoie (2008) used microwave to heat pasta filata curd to 51.6–74°C to improve recuperation of solids and better moisture control before moulding and cooling.

O’Riordon *et al.* (2009) patented a method for making crispy expandable snack product using milk and nondairy ingredients using microwave heat. This group published a series of articles wherein the effect of resistant starch (Arimi *et al.*, 2008a, 2008b), protein to starch ratio (Arimi *et al.*, 2011), water mobility and moisture (Arimini *et al.*, 2008b, 2010) on the microwave assisted expansion of imitation cheese were reported. The crispiness of the imitation cheese product was dependent on the protein, fat and moisture contents. The cheese hardness decreased with increased mobility of water at decreasing protein to starch ratios and prolonged storage and the expanded structure of the cheese was due mainly to the hydrated protein network (Arimi *et al.*,

2011). Acceptable crispiness was found to be corresponding to microwave heating at full power for 58.1 seconds (Arimi *et al.*, 2012).

Gel formation ability of whey proteins is one of the functional properties desired in many applications of whey proteins. Heat-induced gel formation depends on protein concentration, temperature, pH and the presence of ions. Gustaw and Mleko (2007) compared the effect of conventional heating (slow heating) with that of microwave heating (rapid heating) on the structure and hardness of the gels prepared from whey protein isolates (10% protein) dispersed in 0.05–0.5 M salt solution. Effect of varying pH (3–10) for protein dispersion in 0.1 M salt solutions was also assessed. Heating conditions for gel formation were 100 W power for three minutes for MWH and 80°C for 30 minutes for conventional heating followed by cooling at 4°C overnight. The temperature of MWH dispersion was not reported. Gels at pH 3 and 10 had fine structure and harder texture when MW heating was used. The effect was opposite at pH 4–9 with rapid heating during MWH reducing the hardness significantly.

MWH can be used in milk drying (Chandrasekaran *et al.*, 2013; Datta and Anatheswaran, 2001; Fu, 2004). For example, Wang and Guohua (2005) demonstrated that MW can be used to reduce the freeze-drying time of skimmed milk in the presence of a dielectric material. The drying time was reduced to 288.2 minutes from the 455 minutes required by conventional vacuum freeze-drying under same conditions. Souda (1989) and Sochanski *et al.* (1990) used foaming of milk to enhance heat and mass transfer to improve drying process under MW environment.

Due to the rapid rise in temperature of the product, MWH of dairy products can provide equal or better microbial lethality in much less time than conventional heating, leading to retaining superior overall quality of product. There has been number of studies reported over the last few years on the use of dielectric heating (MW and RW) in pasteurization of milk (FDA, 2000; Ahmed and Ramaswami, 2007; Awuah *et al.*, 2007; Villamiel *et al.*, 2009; Salazar-Gonzalez *et al.*, 2012; Korzenszky *et al.*, 2013). Heat inactivation of bacteria of public health importance under MW and RW are discussed in next section. The studies focussing on the effects of dielectric heating on quality of milk and milk products are limited to heating conditions used in pasteurization and sterilization of fluid milk and a few on infant formula where cow milk or milk proteins were used as key raw material (Tessler *et al.*, 2006; Languerre, *et al.*, 2011). As thermal effects are a consequence of temperature and time of heating and the way this combination is achieved, these factors influence both inactivation of microorganisms as well as destruction of the quality of milk. Traditionally, pasteurization is a mild heat treatment and it is generally accepted that loss of quality, both sensory and nutritional, is minimal. For equivalent heat treatment this is also true when MWH is used for pasteurization. The key components of milk are proteins (casein and whey), fat, carbohydrates (lactose), water vitamins and minerals. Out of these components, whey proteins and thiamine are the most heat sensitive and, therefore, are commonly used as indicators of heat damage to milk quality. Heat-induced flavour defects due to whey protein denaturation and browning due to formation of Maillard reaction products are well known in shelf stable or UHT milks where higher temperature are used than for pasteurization (Tamime, 2009) to achieve shelf stability.

MWH does not cause browning, development of cooked or scorched and other flavour defects during pasteurization and subsequent storage (Lopez-Fandino *et al.*, 1996; Valero, *et al.*, 2000). Villamiel *et al.* (1996) reported that lactose in milk underwent more chemical changes than conventional heating when heated by batch MWH as a result of faster heating rate. However, Valero *et al.* (2000) reported no change in

the concentrations of galactose, glucose and myo-inositol in milk heated at 82 and 92°C for 15 seconds by a continuous flow MWH system and conventional heating at the same combinations of temperature and times, even after storage at 4.5°C for 15 days. Lactulose (an isomer of lactose formed due to heat) content in all the samples was lower than 50 mg/l for pasteurized milk (Valero *et al.*, 2000). There was no difference in the production of Maillard reaction products (furosine, hydroxyl methyl furfural and lactulose) when Meissner and Erbersdobler (1996) compared heating of milk by MW and conventional cooking treatments (80–90°C for holding times of 15–420 min). This suggests that the loss of essential amino acids, for example lysine, have less chance of being lost during MWH used for pasteurization.

Lipids can undergo physical and chemical transformation under the influence of heat. This deterioration can manifest into an increase in free fatty acids, formation of trans-fatty acids, autooxidation and reactions with other components of milk, particularly formation of brown colour in proteins via Maillard reaction. It has been observed that microwave boiling of milk resulted in a higher percentage (31%) of trans fatty acids in milk than traditional pasteurization (19%), while the conjugated linoleic acid content of brined white cheese reduced by 21% after microwave boiling and by 53% after microwave heating for 10 minutes (Herzallah *et al.*, 2005). The presence of proteolipids was noticed in milk heated by MW; their concentration was dependent on the intensity and time of exposure to microwave (Kuncewicz *et al.*, 2002). These authors showed that concentration of protein–lipid complexes increased from 0.315 g/100 g in raw milk to 0.432 and 0.805 g/100 g in milk samples heated by microwave at 520 W (90°C) and 1170 W (90°C), respectively. No comparison was made with conventional heat treatment. Except tributyrin acid value, Al-Rowaily (2008) showed no differences in peroxide values, *p*-anisidine values, percentage free fatty acids and totox values for boiling milk by conventional versus microwave heating at 95–96°C for five minutes. Menendez-Carreno *et al.* (2008) compared the effect of heat treatment by MWH (900 W for 1.5 min and 2 min) and electrical heating on a hot plate (90°C for 15 min) on retention of phytosterol contents in commercial milk samples. They showed that intensity of heat treatment (temperature and time) affected degradation of sterols. The amounts of total phytosterols remaining after MWH (1.5 min), MWH (2 min) and hot plate heating were found to be 71%, 34% and 40%, respectively.

Casein and whey proteins are present in milk in various proportions and forms. Both are very well known for their nutritional values and used as key ingredients in infant foods. Of these two, caseins are remarkably heat resistant compared to whey proteins. Normal HTST pasteurization treatment does not affect nutritional value and functionality of milk proteins. Out of whey proteins, β -lactoglobulin is the most heat sensitive and, therefore, it is often used in the assessment of the effect of heat treatments of milk and milk products. Figure 2.4 shows a comparison of the effect of temperature (72–85°C) and holding time (0–25 s) achieved by using MW and conventional heating approaches on percentage denaturation of β -lactoglobulin (Villamiel *et al.*, 2009). In both heating methods, the denaturation depended on the temperature and holding time. High temperature and time progressively increased denaturation; however, the extent of denaturation was less when MWH was used. Also, the denaturation was more in batch MWH systems than continuous systems. A continuous MWH system was either superior or equivalent to conventional heating (Lopez-Fandino *et al.*, 1996; Villamiel *et al.*, 2009). Batch pasteurization of milk by MWH on the other hand

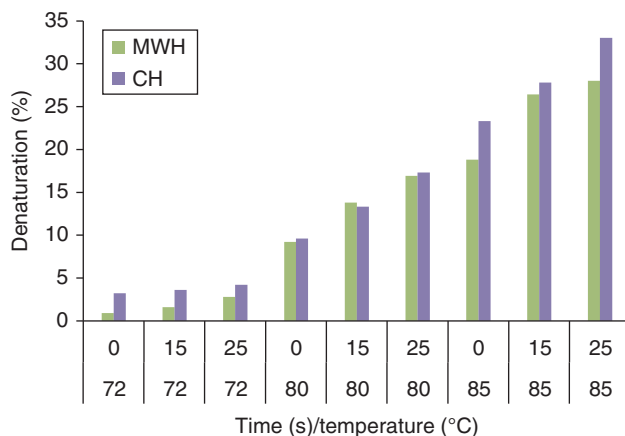

Figure 2.4 Effect of microwave (MWH) and conventional heating (CH) time and temperature on denaturation of β -lactoglobulin in milk (data of Villamiel *et al.*, 2009).

caused more denaturation of whey proteins than the conventional method (Merin and Rosenthal, 1984; Villamiel *et al.*, 1996) due perhaps to uneven heating. Cow's milk is one of the key constituents used in infant formulations to provide the nutritional requirements of infants. In some earlier studies, concern was raised that MWH induced racemization of L amino acids to D amino acids, which were not digestible (Lubec *et al.*, 1989; Lubec, 1990). It has now been proven that there is no evidence of isomerization of amino acids in milk and infant foods upon normal microwave heat treatment (Fay *et al.*, 1991; Marchelli *et al.*, 1992; Vasson *et al.*, 1998; Albert *et al.*, 2009). There was no change in the amounts of amino acid when expressed on total proteins and sample (Albert *et al.*, 2009) basis between conventionally heated and MW heated milk. Based on *in vivo* feeding trials using Wistar rats, Jonker and Penninks (1992) concluded that there was no difference in the net protein use, digestibility and biological values of casein solutions heated conventionally or by using microwave oven to 80°C for five minutes and holding for two minutes. Overall, these studies indicated that nutritional value of milk processed by microwave was either equal or better than when conventional heating methods were used. Microwave heating can, therefore, have potential for replacing traditional pasteurization of milk and milk-based products, including infant foods.

Using a 2.4 kW oven, El-Shibiny *et al.* (1982) found that MWH treatment caused 33–40% denaturation of whey proteins increasing the rennet coagulation time and lower rate of curd formation, fairly important in cheese making. This was later contradicted by Vasavada *et al.* (1995) who concluded that MW treatment milk was superior in coagulation properties than conventionally heat treated milk. In further studies, however, no difference in coagulation properties was found between the two heat treatments by Villamiel *et al.* (1996) and de la Fuente *et al.* (2002) suggesting possibility of using MWH in cheese making.

Batch MWH of milk (700 W power at 2450 MHz) for two ($T = 56^\circ\text{C}$) and four minutes ($T = 80^\circ\text{C}$) has been reported to have induced no loss of α -tocopherol, retinol

and riboflavin (vitamin B₂) in milk (Medrano *et al.*, 1994). It has also been reported that heat treatment of milk in microwave ovens did not damage vitamins A, E, B₁, B₂ and B₆ (Sieber *et al.*, 1996). Sierra *et al.* (Sierra *et al.*, 1999; Sierra and Vidal-Valverde, 2000) found no reduction in vitamin B₁ and B₂ levels of milk heated by a continuous flow microwave system (2450 MHz at 100% power, final milk exit temperature of 85°C at 91 ml/min flow rate, no holding and holding at exit temperature for 40 s) as compared to the conventional heating method (plate heat exchanger with final temperature of 80°C) due to the lack of hot surfaces in contact with milk during heating. Loss of thiamine (B₁) was similar when the holding period was used in both conventional and MWH treatment (Sierra *et al.*, 1999). However, like conventional heating, microwave heated milk has been shown to destroy vitamin B₁ content, the effect being proportional to temperature and time (Vidal-Valverde and Redondo, 1993).

Based on the comparison of continuous flow MW pasteurization with conventional HTST pasteurization, Villamiel *et al.* (1996) found no differences in the sensory quality immediately after heat treatment and upon storage for six days. Despite increased residual proteolytic activity in MW heated milk, no sensory defects could be noticed up to 10 days of storage at 4.5°C. Similarly, Valero *et al.* (2000) found no differences in the taste, odour, flavour and pH of milk pasteurized by MW until 17 days of storage under similar conditions. It is, therefore, possible to extend shelf life of milk using MW pasteurization.

Clare *et al.* (2005) achieved the same microbiological sterility, complete inactivation of plasmin and similar sensory quality attributes in skimmed milk processed by MWH (60 kW system operating at 915 MHz) compared to conventional UHT treatment (137.8°C for 10 s achieved by indirect steam injection) upon storage up to three months. It is, therefore, possible to replace UHT treatment by microwave heating. However, these authors concluded that both treatments produced significantly higher thiol levels compared to normal pasteurized milk. The pattern of the loss of sensory quality over the period of storage time was found to be similar in both conventional UHT and MWH treatments.

RFH has been tested as a potential alternative to processing nondairy foods. Rapid heating and higher penetration depths, possible by applying RF compared to MW, can be of advantage for heating, particularly when high penetration depths are required for heating higher volumes of solids or liquids. Reported uses include blanching, pasteurizations, sterilization, thawing and drying of fruits, vegetables and meat and baked products [Marra *et al.*, 2009]. While providing high heating efficiency, the cost of operating of these units has limited RFH to investigations on a laboratory scale.

The effect of RFH on microorganisms and food constituents particularly milk has not been studied in detail. Using continuous flow systems (2 kW, 27.12 MHz), Awuah *et al.* (2005) reported that RFH effectively destroyed pathogens surrogates, such as *Listeria innocua* and *E. coli* K-12, in milk and could be effective in pasteurizing milk. *E. coli* K-12 was more sensitive to RFH than *Listeria*. The nonthermal effect of RFH with regards to microbial inactivation is, however, believed to be almost negligible under the usual operating condition (Vincente and Castro, 2007). Lagunas-Solar *et al.* (2005) argued that RF may be cost effective for treatment of dairy farm wastewater infected with bacterial pathogens such as *Salmonella* sp., *Escherichia coli* O157:H7 and *Mycobacterium avium* ssp. *paratuberculosis* before recycling. Using a research RF system, complete inactivation of pathogens was reported in <1 minute when temperatures of 60–65°C were reached (Lagunas-Solar *et al.*, 2005).

2.4 Aspects of Microbiological Safety of Dairy Products

One of the key issues in assuring the safety of dairy products is how effective the treatment is in inactivating microorganisms of public health concern yet preserving the quality of the product. With direct (OH) and indirect (MW and RF) heating the microorganisms are mainly inactivated by heat. However, nonthermal effects, such as selective absorption of energy, electroporation, cellular and membrane damages, as other mechanisms of inactivation have also been reported (Kozempel *et al.*, 1998, 2000) but not yet conclusively (Koutchma *et al.*, 2001; Lin and Ramaswami, 2011). Some evidence of mild electroporation of cell at lower frequency (50–60 Hz) can complement the predominant heat effects (Ruan *et al.*, 2004) during ohmic heating. Geveke *et al.* (2000) found RF treatment of liquids at 18 MHz and 0.5 kV/cm electrical field strength failed to have any nonthermal lethal effect on *E. coli* K-12, *Listeria innocua* and yeasts. It is generally accepted that preservation and processing effects of electromagnetic methods (ohmic, MW and RW) result mainly from an increase in the temperature of the product, as in the case of conventional heating. Therefore, approaches similar to traditional methods of heating are acceptable for assessing the effects on microorganisms.

To establish processing calculations, such as in pasteurization and sterilization by heat, the data on heat resistance of the target microorganism, physiological stages (vegetative or spore) and heat penetration characteristics of product are used to provide desired lethality. The destruction of the microorganism or enzyme due to heat at a particular temperature is assumed to follow chemical reaction kinetics as follows:

$$\frac{dN}{dt} = -kN^n \quad (2.8)$$

$$k = 2.303/D \quad (2.9)$$

$$\log \frac{D}{D_r} = -\frac{T - T_r}{z} \quad (2.10)$$

$$F_0 = \int_0^t 10^{\frac{T-T_r}{z}} dt \quad (2.11)$$

where N is the number of microorganism or concentration of enzyme, t is treatment time, k is a death (reaction) constant and n is the order of the reaction, normally taken as first order. Both k and D (time required to reduce microbial population by one log cycle at a defined temperature) are related (Equation 2.2) and have been extensively reported for several microorganisms of concern (FDA, 2000; Anantheswaran and Ramaswami, 2001). There has been considerable evidence gathered over the years (Geeraerd *et al.*, 2004; Peleg, 2004) proving beyond doubt that assuming linearity of heat inactivation of microorganisms is too simplistic and leads to errors. D and D_r are decimal reduction times at a given temperature (T) and reference temperature (T_r), respectively. The effect of change in temperature on the survival of microorganisms is arrived at by plotting the decimal reduction time data for different temperatures. The slope off the line facilitates calculation of z value (temperature coefficient) as is defined in Equation 2.10. Corrections may be needed to D and z values to account for heating effects during heat come up and come down times (Tajchakavit and Ramaswamy,

1995; Ahmed and Ramaswami, 2007; Lin and Ramaswami, 2011) for MW and RF heating.

The z values of bacteria and nutrients are typically around 10°C and 25°C, respectively (Datta and Hu, 1992). This means that microorganisms are more sensitive to heat than nutrients. This has been the basis of the use of heat to assure the microbiological safety of foods without destroying the nutrients. When the product is undergoing heating, the extent of heat treatment is an integrated time temperature history to calculate F_0 (Equation 2.11) for achieving target lethality for a particular microorganism of concern for a dairy product at the cold spot to be pasteurized or sterilized. The conventional heating cycle required for pasteurization or sterilization is characterized in four phases: time required to come up to the desired temperature, equilibration time, hold up time at process temperature and cool down time. Each of these phases contributes to lethality. Due to the rapid increase in the product temperature in dielectric and ohmic heating, the duration of the first phase (come up time) is insignificant and, hence, contributes very little to the F_0 (Datta and Hu, 1992), leading to significant advantages in terms of retaining product quality attributes compared to conventional heating systems. Duration of the rest of the heating cycle phases is expected to be similar in dielectric heating (Harlfinger, 1992).

Tables 2.6 and 2.7 show comparisons of the inactivation kinetic data for alkaline phosphate enzyme, denaturation of proteins, and selected microorganisms for OH and dielectric heating (MW and RF), respectively. The data indicate clearly that D values obtained by nonconventional heating were significantly lower than ohmic or dielectric heating temperatures. This indicates a further significant advantage of using nonconventional thermal methods in inactivating microorganisms and enzymes. In certain cases, there has been an order of magnitude reduction in the values, suggesting the possibility of using dielectric heating for pasteurization and stabilization of dairy foods. It has also been demonstrated that the D values calculated from the continuous-flow heating mode were significantly lower than when batch mode was used (Koutchma *et al.*, 2001) due to uniform heating and temperature profile possibly due to continuous stirring of the liquid.

For thermal processes where the rise in temperature is the key mechanism of inactivation of microorganisms, identification of the cold spot and making sure that the product at this spot achieves the required temperature to guarantee lethality are the most important safety legal requirements the dairy industry must comply with. Depending on the mode of heat transfer, location of the cold spot in conventional heating situation is either the geometric centre in solid product or below centre in liquids without agitation. In volumetric heating methods, identification of the location of the cold spot is not straightforward, as heat is continuously generated within the product at different rates; these rates are influenced by several factors, including the product composition, the frequency, equipment design, power level and so on. Coronel *et al.* (2003) studied temperature profile of milk in a continuous flow tubular MWH system at 915 MHz at skimmed milk flow rates of 2 and 3 l/min. For the cross-section of the tube (internal diameter = 0.039 m, length 0.124 m) and laminar flow conditions, both hot and cold spots were dependent on the flow rate and inlet temperature. The location of the cold temperature spot was closer to the tube walls in the MWH system. The location of the cold spot in ohmic heating is not easy to predict with presence of runaway heating, as in MWH (FDA, 2000). Details can be accessed in the exhaustive discussion papers available on the US Food & Drug Administration (FDA) web site. The determination of cold spot has been attempted by several researchers recently by measuring the

Table 2.6 Comparison of heat inactivation kinetics by conventional and ohmic heating

Microorganism	Substrate	Temperature (°C)	D (min)		Z (°C)		References
			CH	OH	CH	OH	
<i>Bacillus subtilis</i> (spores)	Nutrient broth	88	32.8	30.2	8.74	9.16	Cho <i>et al.</i> , 1999
		92.3	9.87	8.55			
		95	5.06				
		95.5		4.38			
		97	3.05				
		99.1		1.76			
Aerobes	Milk	57	11.25	8.64	10.1*	10.7*	Sun <i>et al.</i> , 2008
		60	9.39	6.18			
		72	0.44	0.38			
<i>Streptococcus thermophilus</i>	Milk	70	7.54	6.59	6.3*	6.2*	Sun <i>et al.</i> , 2008
		75	3.3	3.09			
		80	0.2	0.16			
<i>E. coli</i>	Goat milk	55	10.9	14.2	19.5*	8.5*	Pereira <i>et al.</i> , 2007
		63	3.9	1.9			
		65	3.5	0.86			
Alkaline phosphatase	Milk	55	35.46	31.75	9.05	9.3	Castro <i>et al.</i> , 2004
		60	19	11			
		65	3.54	2.89			
		70	0.91	0.89			
β-galactosidase	Broth	65	182		5.12	5.08	Castro <i>et al.</i> , 2004
		70	33.9				
		72	12.8	9.70			
		75	2.99	2.77			
		78	0.52	0.64			
		80	0.50	0.28			

*Calculated from the D value data

amounts of Maillard browning reaction products, commonly known as M1 and M2. Later on, computer vision was employed for different food models to identify cold spots (Pandit *et al.*, 2007) in microwave heating conditions.

Based on the comparison of death kinetics of *E. coli* and yeast in ohmic and conventional heating, Palaniappan *et al.* (1992) concluded that thermal effects are mainly responsible for inactivation of microorganisms in ohmic heating. The inactivation effects of OH are compared in Table 2.5 for different microorganism and enzymes important in dairy heating applications. In general, heat resistance of bacteria and

Table 2.7 Comparison of decimal reduction times (D) at different temperatures by conventional (CH) and microwave (MW) and radio frequency (RF) heating

Enzyme/ Microorganism	System	Temperature (°C)	D (s)		Reference
			CH	MW (2450 MHz) or RF	
Alkaline phosphatase (MW)	Milk in a continuous flow system	60	1250	–	Lin and Ramaswami, 2011
		65	182.7	17.6	
		67	16.6	6.3	
		70	8.9	1.7	
<i>E. coli</i> K-12 (MW)	Juice in a continuous flow system	55	44.7	12.98	Ramaswami <i>et al.</i> , 2000
		60	26.8	6.31	
		65	2.0	0.78	
<i>E. coli</i> K-12 (MW)	Water	55	170 (B)	20 (CMHHC)	Koutchma <i>et al.</i> , 2001
		60	73 (CHHC)	13 (CMHC)	
		65	18.0(B)	8.3 (CMHHC)	
			18.0 (CHHC)	6.3 (CMHC)	
			2.0 (B)	2.0 (CMHHC)	
			3.0 (CHHC)	0.78 (CMHC)	
<i>E. coli</i> K-12 (RFH 27.12 MHz)	Milk in a continuous flow system	54.2	–	56.3	Awuah <i>et al.</i> , 2005
		59	–	24.1	
		62.1	–	14.9	
		65.2	–	7.6	
		60.6	–	11.3	
		62.2	–	6.5	
		–	–	–	
<i>Listeria innocua</i> (RFH 27.12 MHz)		54.2	–	67.6	Awuah <i>et al.</i> , 2005
		59	–	60.2	
		62.1	–	41.9	
		65.2	–	11.8	
		60.6	–	39.0	
		62.2	–	17.6	
		–	–	–	

B – Batch heating in water bath, CHHC – continuous flow with heat-hold-cool set up, CMHHC – continuous flow microwave oven heat – hold – cool system, CMHC – continuous flow microwave oven heat – cool system

yeasts, as indicated by D values, was significantly lower at higher temperatures and at a lower temperature range there was no significant difference in kinetic parameters (D, k values), suggesting that the key mechanism of inactivation was still thermal. Interestingly, z values for most bacteria and enzymes were similar in both types of heating. Some studies have indicated that electricity can have additional effects on inactivation of microorganisms (Cho *et al.*, 1999), possibly by lowering their resistance to heat due to electroporation, which may suggest a possible use of OH as a pretreatment to conventional heating to improve its effectiveness and reduce

the temperature–time duration of heating. Under identical temperature history conditions, Sun *et al.* (2008) reported significantly lower D values than those obtained by conventional heating for viable aerobes and *S. thermophilus* in milk at 70 and 80°C. Selective absorption of electromagnetic energy has been proposed to compliment the thermal effect in killing microorganisms (Palaniappan and Sastry, 1990) in ohmic heating and should be an added advantage in assuring the safety of dairy products.

Microwaves are reported to be as effective as traditional heating procedures in inactivating microorganism and enzymes in dairy foods. Comparison of heat inactivation kinetics under microwave and conventional heating for bacteria and enzymes important in dairy processing are given in Table 2.6. Data show that bacteria are more sensitive to microwave heating at the same temperature as D values are consistently lower. The pattern depends on whether continuous or batch conditions were used in determination of kinetics. At around 70°C, the reduction in D values was five times that of conventional heating, particularly for inactivation of alkaline phosphatase enzymes, which is used as an index of the adequacy of pasteurization of milk. This technology also provides the added benefit of post-packaging pasteurization of products, which can be useful in manufacture of some types of yogurt and processed milk or products that are prone to rapid spoilage due to surface microbial growth, such as certain soft cheese varieties.

Apart from heat-related inactivation of microorganisms, other nonthermal mechanisms that may contribute to inactivation of microorganism include electroporation, cell membrane rupture and magnetic field coupling (Khalil and Villota, 1989; Kozempel, *et al.*, 2000; Ramaswami *et al.*, 2000). These effects may complement the thermal effects. Based on the kinetic data of inactivation of alkaline phosphatase enzymes (used for assessing the adequacy of pasteurization of milk), Lin and Ramaswami (2011) demonstrated an order of magnitude increase in thermal effects of continuous flow MW heating over conventional heating for equivalent pasteurization of milk. Continuous flow microwave systems have considerable advantages over batch systems, both from the view of inactivation of microorganisms of concern and retention of quality attributes. However, nonuniform heating by microwaves, particularly in solid foods, can result in cold spots in the food that could result in the survival of microorganisms and pathogens, leading to safety risks in foods (Vincente and Castro, 2007). Some studies (Cho *et al.*, 1993; Knutson *et al.*, 1988) have indicated that heating of milk in a microwave oven at a temperature and time used in normal pasteurization failed to inactivate pathogens such as *Salmonella typhimurium* yet others maintain that MWH caused sublethal injuries to other milk-borne pathogens such as *Listeria monocytogenes*, *Staph. aureus* and *E. coli* (Stearns and Vasavada, 1986; Galuska *et al.*, 1989). Variations in the volume of milk exposed to MWH have also been observed to influence the inactivation of *L. monocytogenes* (Cho *et al.*, 1993). However, heat treatments to 95°C are reported to completely inactivate bacteriophages in cheese whey (Vasavada, 1990). This may be due to differences in the experimental conditions used by these workers. This might have contributed to differences, as has been shown in Tables 2.6 and 2.7.

Despite of the advantages of rapid heating with minimal damage to the quality of dairy foods due to higher penetration depth, applications of RFH reported for pasteurization and sterilization of milk and milk products are promising but limited to the laboratory scale. Rapid heating and higher penetration depths possible by applying RF compared to MW can be of advantage for heating, particularly when high penetration depths are required for heating higher volumes of solids or liquids. The

effect of RFH on microorganisms and food constituents, particularly milk, has not been studied in detail. Using continuous flow systems (2 kW, 27.12 MHz), Awuah *et al.* (2005) reported that RFH effectively destroyed pathogens surrogates, such as *Listeria innocua* and *E. coli* K-12, in milk and could be effective in pasteurizing milk. *E. coli* K-12 was more sensitive to RFH than *Listeria*. The nonthermal effect of RFH with regards to microbial inactivation is, however, believed to be almost negligible under the usual operating condition (Vincente and Castro, 2007). In a study using RF for sterilization of macaroni cheese and whey protein gels, Wang *et al.* (2003b) reported that RF (27 MHz) heating provided a F_0 value (10 min) within 30 minutes of treatment compared to 90 minutes in conventional retorting. This means that, for equivalent lethality, RF treatment can reduce heating time significantly to retain better quality (sensory and nutritional) of product.

2.5 Conclusions

Alternative thermal technologies discussed in this chapter will continue to be investigated in response to consumer demands for fresh and wholesome products without compromising the safety. Several advantages offered by these techniques are related to the generation of heat within dairy product. It is possible to rapidly reduce the processing temperature and times for pasteurization and sterilization, as significant reduction in the D and z values of the microorganisms in milk and milk products is possible using continuous flow systems. While the mechanism of destruction is still accepted to be thermal, some presence of nonthermal effects has been argued, but more conclusive evidence is needed. In any case, from a practical point of view, the presence of nonthermal effects should add to making dairy products safer yet assure the same or superior overall quality compared to traditional heating methods. However, there are some obstacles that prevent application of these technologies in the dairy industry. These have been discussed in many publications (FDA, 2000; Vicente *et al.*, 2006; Zhao, 2006; Ahmed and Ramaswami, 2007; Marra *et al.*, 2009; Villamiel *et al.*, 2009; Salazar-Gonzalez *et al.*, 2012). Major hurdles are lack of generalized information or validation procedures for the safety of treated dairy foods, higher capital and operating costs associated with process equipment and lack of data on the properties needed for proper designs of process and equipment. It is clear that the unpredictability of cold spots can put the safety of dairy foods at risk. The complexity of heating phenomena of milk and its myriad processed products have also limited applications in the dairy industry. The lack of experimental data needed to model these technologies as well as the engineering intelligence to understand and minimize uneven heating have added to the problems. More specifically, the lack of predictive models relating the electrical properties of foods to transient time–temperature profiles (that determine product quality and food safety) has been another major obstacle in the development of these technologies. The chances of runaway and uneven heating are not fully understood and need further research.

It is known that the dairy industry and consumers are conservative about adoption of new technologies. Yet, research opportunities in the technological areas of alternate thermal technologies are far from being exhausted. Applications, such as radio and microwave assisted reactions, will continue to grow due to the superiority and significant cost advantages offered compared to traditional methods. There will be future opportunities for innovations, particularly for process intensification where heat is used. For example, volumetric heating can be used in combination with

conventional heating to enhance rate of drying. Improving the processes used in dairy processing waste treatment by the use of RF and MW heating has a future in both reduction of microbial load and sludge stabilization for further processing. There is need for in-depth research with regards to temperature distribution within dairy products, the kinetics of inactivating microorganisms (spoilage and disease causing) under application conditions and the effects on nutrients as well as the effect of these technologies on various milk constituents. These studies are important to confirm the safety and nutritional aspects of dairy products processed using these technologies.

References

- Ahmed, J. and Ramaswami, H.S. (2007) Microwave pasteurization and sterilization of foods, in *Handbook of Food Preservation*, 2nd edn (ed. M.S. Rahman). CRC Press, pp. 691–711.
- Ahmed, J. and Luciano, G. (2009) Dielectric properties of β -lactoglobulin as affected by pH, concentration and temperature. *Journal of Food Engineering*, **95**: 30–35.
- Ahmed, J., Ramaswami, H.S. and Raghavan, V.G.S. (2007) Dielectric properties of butter in the MW frequency range as affected by salt and temperature. *Journal of Food Engineering*, **82**: 351–358.
- Aider, M., de Halleux, D. and Melnikova, I. (2008) Gravitational and microwave-assisted thawing during milk whey cryoconcentration. *Journal of Food Engineering*, **88**: 373–380.
- Al-Rowaily, M.A. (2008) Effect of heating treatments, processing methods and refrigeration of milk and some dairy products on lipid oxidation. *Pakistan Journal of Nutrition* **7**(1): 118–125.
- Albert, Cs, Mandoki, Zs, Csapo-Kiss, Zs and Csapo, J. (2009) The effect of microwave pasteurization on the composition of milk. *Acta Univ. Sapientiae, Alimentaria*, **2**: 153–165.
- Anantheswaran, A and Ramaswami, H. (2001) Bacterial destruction and enzyme inactivation in microwave heating, in *Handbook of Microwave Technology for Food Applications* (eds A.K. Data and A. Anantheswaran). Marcel Dekker, Inc, New York, pp 191–213.
- Anderson, A.K. and Finkelstein, R. (1919) A study of the electropure process of treating milk. *Journal of Dairy Science*, **2**: 374.
- Anon (2013) Lactoscan: Conductivity measurement. http://www.lactoscan.com/usefull_info/english/conduct.html (last accessed 29 December 2014.)
- Ansari, M.I.A. and Datta, A.K. (2007) Preservation of liquid milk using emerging technologies. *Indian Dairyman*, **59**: 59–65.
- Arimi, J.M., Duggan, E., O’Riordan, E.D. *et al.* (2008a) Microwave expansion of imitation cheese containing resistant starch. *Journal of Food Engineering*, **88**(2): 254–262.
- Arimi, J.M., Duggan, E., O’Sullivan, M. *et al.* (2008b) Effect of refrigerated storage on water mobility and microwave expansion of imitation cheese containing resistant starch. *Journal of Food Engineering*, **89**(3): 258–266.
- Arimi, J.M., Duggan, E., O’Riordan, E.D. *et al.* (2010) Effect of moisture content and water mobility on microwave expansion of imitation cheese. *Journal of Food Chemistry* **121**(2): 509–516.
- Arimi, J.M., Duggan, E., O’Sullivan, M. *et al.* (2011) Effect of protein:starch ratio on microwave expansion of imitation cheese-based product. *Food Hydrocolloids* **25**(5): 1069–1076.

- Arimi, J.M., Duggan, E., O'Sullivan, M. *et al.* (2012) Crispiness of a microwave-expanded imitation cheese: mechanical, acoustic and sensory evaluation. *Journal of Food Engineering*, **108**(3): 403–409.
- Augustin, M.A. and Clarke, P.T. (2008) Dry milk products, in *Dairy Processing and Quality Assurance* (eds R.C. Chandan, A. Kilara and N. Shah). John Wiley & Sons, Ltd, pp. 319–336.
- Awuah, G.B., Ramaswamy, H.S., Economides, A. and Mallikarjun, K. (2005) Inactivation of *Escherichia coli* K-12 and *Listeria innocua* in milk using radio frequency (RF) heating. *Innovative Food Science and Emerging Technologies*, **6**: 396–402.
- Awuah, G.B., Ramaswamy, H.S. and Economides, A. (2007) Thermal processing and quality: Principles and overview. *Chemical Engineering and Processing*, **46**: 584–602.
- Ayadi, M.A., Bouvier, L., Chopard, F. *et al.* (2003) Heat treatment improvement of dairy products via ohmic heating processes: thermal and hydrodynamic effect on fouling, in *Heat Exchanger Fouling and Cleaning: Fundamentals and Applications* (eds P. Watkinson, H. Müller-Steinhagen and M. Reza Malayeri), ECI Symposium Series, Volume RP1. <http://dc.engconfintl.org/heatexchanger/19> (last accessed 29 December 2014).
- Ayadi, M.A., Leuliert, J.C., Chopard, F. *et al.* (2004). Continuous ohmic heating unit under whey proetin fouling. *Innovative Food Science and Emerging Technologies*, **5**: 465–473.
- Ayadi, M.A., Leuliert, J.C., Chopard, F. *et al.* (2005) Experimental study of hydrodynamics in a flat ohmic cell-impact on fouling of dairy products. *Journal of Food Engineering*, **70**(4): 489–498.
- Bansal, B. and Chen, X.D. (2005) Fouling of heat exchanges by dairy fluids. ECI Symposium Series, Vol RP2. Retrieved from https://researchspace.auckland.ac.nz/bitstream/handle/2292/4462/ECI_2005_23.pdf?sequence=1 (last accessed 7 January 2015).
- Bansal, B. and Chen, X.D. (2006) Effect of temperature and power frequency on milk fouling in an ohmic heater. *Food and Bioproduct Processing*, **84**(C4): 286–291.
- Buffler, C.R. (1993) *Microwave Cooking and Processing*. Van Nostrand Reinhold, NY.
- Calay, R.K., Newborough, M., Probert, D. and Calay, P.S. (1995) Predictive equations for the dielectric properties of foods. *International Journal of Food Science and Technology*, **29**: 699–713.
- Castro, I., Macedo, B., Teixeira, J.A. and Vicente, A.A. (2004) The effect of electric field on important food processing enzymes: Comparison of inactivation kinetics under conventional and ohmic heating. *Journal of Food Science*, **69**: 696–701.
- Chandan, R.C. (2008) Dairy processing and quality assurance: An overview, in *Dairy Processing and Quality Assurance* (eds R.C. Chandan, A. Kilara and N. Shah). John Wiley & Sons, Ltd, pp. 1–40.
- Chandrasekaran, S., Ramanathan, S., and Basak, T. (2013). Microwave Food Processing-A review. *Food Research International* **52**: 243–261
- Chiu, C.P., Tateishi K., Kosikowski, F.V and Armbruster, G. (1984) Microwave treatment of pasteurized milk. *Journal of Microwave Power*, **19**: 269–272.
- Cho, K., Marth, E.H. and Vasavada, P.C. (1993) Use of microwave energy to inactivate *Listeria monocytogenes* in milk. *Milchwissenschaft*, **48**: 200–203.
- Cho, H.-Y., Yousef, A. E. and Sastry, S. K. (1999) Kinetics of inactivation of *Bacillus subtilis* spores by continuous or intermittent ohmic and conventional heating. *Biotechnology and Bioengineering*, **62**: 368–372.

- Clare, D.A., Bang, W.S., Cartwright, G. *et al.* (2005) Comparison of sensory, microbiological and biochemical parameters of microwave versus indirect UHT fluid skim milk during storage. *Journal of Dairy Science*, **88**: 4172–4182.
- Coronel, P., Simunovic, J. and Sandeep, K.P. (2003) Temperature profiles within milk after heating in a continuous-flow tubular microwave system operating at 915 MHz. *Journal of Food Science*, **68**(6) 1976–1981.
- Datta, A.K. and Anantheswaran, R.C. (2001) *Handbook of Microwave Technology for Food Applications*. Marcel Dekker, Inc, New York.
- Datta, A.K. and Hu, W. (1992). Quality optimisation of dielectric heating processes. *Food Technology* **46**: 53–56.
- Datta, A.K., Sun, E. and Solis, A. (1995) Food dielectric property data and their composition-based prediction, in *Engineering Properties of Foods*, 2nd edn (eds M.A. Rao and S.S.H. Rizvi). Marcel Dekker, Inc, New York, pp. 457–494.
- Datta, A.K., Sumnu, G. and Raghavan, G.S.V. (2005) Dielectric properties of foods, in *Engineering Properties of Foods* (eds M.A. Rao, S.S.H. Rizvi and A. Datta). Taylor and Francis, pp. 501–566.
- Decareau, R.V. (1985). *Microwave in Food Processing Industry*. Academic Press, Orlando, FL.
- El-Shibiny, S., Sabour, M.M., El-Alamy, H.A. and Alam S. (1982) Effect of microwaves on buffalo's milk. *Egyptian Journal of Dairy Science*, **10**: 29–34.
- Farkye, N.Y. (2008) Evaporated and sweetened condensed milks, in *Dairy Processing and Quality Assurance* (eds R.C. Chandan, A. Kilara and N. Shah). John Wiley & Sons, Ltd, pp. 309–318.
- Fay, L., Richli, U. and Liardon, R. (1991) Evidence for the absence of amino acid isomerisation in microwave-heated milk and infant formulas. *Journal of Agricultural and Food Chemistry*, **39**: 1857–1859.
- Firouzi, R., Shekatforoush, S.S. and Mojaver, S. (2005) Destruction effect of microwave radiation on *Listeria monocytogenes* biotype 4A in milk. *Advances in Food Science* **27**: 131–134.
- FDA (Food and Drug Administration) (2000) Kinetics of microbial inactivation for alternative food processing technologies. Retrieved from <http://www.fda.gov/food/foodscienceresearch/safepacticesforfoodprocesses/ucm100158.htm> (last accessed on 25/7/2013.)
- Fu, Y.C. (2004) Fundamental and industrial applications of microwave and radio frequency in food processing, in *Food Processing: Principles and Applications* (eds J.S. Smith and Y.H. Hui). Blackwell Publishing, IA, pp. 79–100.
- de la Fuente, M.A., Olano, A. and Juarez, M. (2002) Mineral balance in milk heated using microwave energy. *Journal of Agricultural and Food Chemistry*, **50**: 2274–2277.
- Galuska, P.J., Kolarik, R.W., Vasavada, P.C. and Marth, E.H. (1989) Inactivation of *Listeria monocytogenes*. *Journal of Dairy Science*, **72**: 139.
- Geeraerd, A.H., Valdramidis, V.P. Bernaerts, K. and Van Impe, J.F. (2004) Evaluating microbial inactivation models for thermal processing, in *Improving the Thermal Processing of Foods* (ed. P. Richardson). Woodhead Publishing Ltd, Cambridge, UK, pp. 427–453.
- Getchell, B.E. (1935). Electric pasteurization of milk. *Agriculture Engineering*, **16**(10): 408–410.

- Geveke, D.J., Kozempel, M., Scullen, O.J. and Brunkhorst, C. (2000) Radio frequency energy effects on microorganism in foods. *Innovative Food Science and Emerging Technologies*, **3**: 133–138
- Gustaw, W and Mleko, S. (2007) Gelation of whey proteins by microwave heating. *Milchwissenschaft*, **62**(4): 439.
- Harlfinger, L. (1992) Microwave sterilization. *Food Technology*, **46**(12): 57–61.
- Herve, A.G., Tang, J., Luedecke, L. and Feng, H. (1998) Dielectric properties of cottage cheese and surface treatment using microwaves. *Journal of Food Engineering*, **37**: 389–410.
- Herzallah, S.M, Humeid, M.A. and Al-Ismail, K.M. (2005) Effect of heating and processing methods of milk and dairy products on conjugated linoleic acid and trans fatty acid isomer content. *Journal of Dairy Science*, **88**(4)1301–1310.
- Housova, J. and Hoke, K. (2002) Microwave heating-influence of oven and load parameters on the power absorbed in the heated load. *Czech Journal of Food Science*, **20**(3): 117–124.
- Icier, F. (2009) Influence of ohmic heating on rheological and electrical properties of reconstituted whey solutions. *Food and Bioproducts Processing*, **87**: 308–316.
- Icier, F. and Tavman, S. (2006) Ohmic heating behaviour and rheological properties of ice cream mixes. *International Journal of Food Properties*, **9**: 679–689.
- Isse, M.G. and Savoie, L. (2008) Process for making pasta filata. US Patent 2008/0131557 A1.
- Jonker, D. and Penninks, A.H. (1992) Comparative study of the nutritive value of casein heated by microwave and conventionally. *Journal of Science of Food and Agriculture*, **59**: 123–126.
- Khalil, H. and Villota, R. (1989) The effect of microwave sub-lethal heating on the ribonucleic acids of *Staphylococcus aureus*. *Journal of Food Protection*, **52**: 544–548.
- Kilara, A. and Chandan, R.C. (2008) Ice cream and frozen desserts, in *Dairy Processing and Quality Assurance* (eds R.C. Chandan, A. Kilara and N. Shah). John Wiley & Sons, Ltd, pp. 357–386.
- Kim, H.J, Choi, Y.M, Yang, E.C.S. *et al.* (1996) Validation of OH for quality enhancement of food products. *Food Technology*, **50**: 253–261.
- Knutson, K.M., Marth, E.H. and Wagner M.K. (1988) Use of microwave ovens to pasteurize milk. *Journal of Food Protection*, **51**: 715–719.
- Korzenszky, P., Senbery, P. and Geczi, G. (2013) Microwave milk pasteurisation without food safety risk. *Portavinarstvo*, **7**(1): 45–48.
- Koutchma, T., Le Bail, A. and Ramaswami, H.S. (2001) Comparative experimental evaluation of microbial destruction in continuous flow microwave and conventional heating systems. *Canadian Biosystems Engineering*, **43**: 3.1-3.8
- Kudra, T., van de Voort, F.R., Raghavan, G.S.V. and Ramaswami, H.S. (1991). Heating characteristics of milk constituents in microwave pasteurisation system. *Journal of Food Science* **56**(4): 931–934.
- Kudra, T., Raghavan, V., Akyel, C. *et al.* (1992). Electromagnetic properties of milk and its constituents at 2.45 GHz. *Journal of International Microwave Power Institute* **27**(4): 199–204.
- Kumar, P., Coronel, P., Simunovic, J. and Sandeep K.P. (2007) Measurement of dielectric properties of pumpable food materials under static and continuous flow conditions. *Journal of Food Science*, **72**: E177-183.

- Kuncewicz, A., Michalak, J., Panfil-Kuncewicz, H. *et al.* (2002) Influence of microwave heating on the formation of proteolipids in milk. *Milchwissenschaft*, **57**: 250–253.
- Kozempel, M., Annous, B.A., Cook, R.D. *et al.* (1998) Inactivation of microorganisms with microwaves at reduced temperature. *Journal of Food Processing* **61**: 582–585.
- Kozempel, M., Cook, R.D., Scullen, O.J. and Annous, B.A. (2000) Development of a process for detecting non-thermal effects of microwave energy on microorganisms at low temperature. *Journal of Food Processing and Preservation*, **24**: 287–301.
- Laguerre, J.-C., Pascale, G.-W., David, M. *et al.* (2011) The impact of microwave heating of infant formula modrl on neo-formed contaminant formation, nutrient degradation and spore destruction. *Journal of Food Engineering*, **107**: 208–213.
- Lagunas-Solar, M.C., Cullor, J.S., Zeng, N.X. *et al.* (2005). Disinfection of dairy and animal farm wastewater with radiofrequency power. *Journal of Dairy Science*, **88**(11): 4120–4131.
- Lima, M. (2007) Food preservation aspects of ohmic heating, in *Handbook of Food Preservation* (ed. M.S. Rahman). CRC Press, FL, pp. 741–750.
- Lin, M. and Ramaswamy, H. (2011) Evaluation of phosphatase inactivation kinetics in milk under continuous flow microwave and conventional heating conditions. *International Journal of Food Properties*, **14**: 110–123.
- López-Fandiño, R., Villamiel, M., Corzo, N. and Olano, A. (1996) Assessment of thermal treatment of milk during continuous microwave and conventional heating. *Journal of Food Protection*, **59**: 889–892.
- Lubec, G. (1990) D-amino acids and microwaves. *Lancet*, **335**: 792
- Lubec, G., Wolf, C. and Bartosch, B. (1989) Amino acids isomerisation and microwave exposure. *Lancet* **334**: 1392–1393
- Mabrook, M.F. and Petty, M.C. (2003). Effect of composition on the electrical conductance of milk. *Journal of Food Engineering*, **60**: 321–325
- Mainville, I., Montpetit, D., Durand, N. and Farnworth, E.R. (2001) Deactivating the bacteria and yeast in kefir using heat treatment, irradiation and high pressure. *International Dairy Journal*, **11**: 45–49.
- Marchelli, R., Dossena, A., Palla, G. *et al.*, (1992). D-Amino acids in reconstituted infant formula: A comparison between conventional and microwave heating. *Journal of the Science of Food and Agriculture*, **59**: 217–226.
- Marra, F., Zhang, L. and Lyng, J.G. (2009) Radio frequency treatment of foods: Review of recent advances. *Journal of Food Engineering*, **91**: 497–508.
- Meda V., Orsat, V. and Raghavan, G.S.V. (2005) Microwave heating and dielectric properties of foods, in *The Microwave Processing of Foods* (eds H. Schuder and M. Regier). CRC Press, Woodhead Publishing Ltd., Cambridge, pp 61–75.
- Medrano, A., Hernandez, A., Prodanov, M. and Vidal-Valverde, C. (1994). Riboflavin, α -tocopherol and retinol retention in milk after microwave heating. *Lait*, **74**: 153–159.
- Meissner, K. and Erbersdobler, H.F. (1996). Maillard reaction in microwave cooking: comparison of early Maillard products in conventionally and microwave-heated milk. *Journal of the Science of Food and Agriculture*, **70**(3): 307.
- Menendez-Carreno, M., Ansorena, D. and Astiasaran, I. (2008) Stability of sterols in phytosterol-enriched milk under different heating conditions. *Journal of Agricultural and Food Chemistry*, **56**: 9997–10002.
- Merin, U. and Rosenthal, I. (1984) Pasteurization of milk by microwave irradiation. *Milchwissenschaft*, **39**: 643–644.

- Michael, B. (2009) Cook-stable ice cream fillings for use in consumer heatable pastry products. US Patent 2009/0285945 A1.
- Mudgett, R.E. (1986) Microwave properties and heating characteristics of foods. *Food Technology*, **40**(6): 84–93
- Mudgett, R.E. (1995) Electrical properties of foods, in *Engineering Properties of Foods*, 2nd edn (eds M.A. Rao and S.S.H. Rizvi). Marcel Dekker, Inc, New York, pp. 389–456.
- Nielen, M., Deluyker, H., Schukken, Y.H. and Brand, A. (1992). Electrical conductivity of milk: measurement, modifiers, and meta analysis of mastitis detection performance. *Journal of Dairy Science*, **75**: 606–614.
- Ohlsson, T. and Bengtson, N. (2001) Microwave technology and foods. *Advances in Food and Nutrition Research*, **43**: 65–81.
- O’Riordan, D., O’Sullivan, M., Lyng, J.G. and Duggan, E (2009) Heat-expanded food products. Patent No. WO 2009056331 A (<https://www.google.com/patents/WO2009056331A1?cl=en>; last accessed 7 January 2015).
- Palaniappan, S. and Sastry, S.K (1990) Effect of electricity on microorganisms: A review. *Journal of Food Preservation and Processing*, **14**: 393–414.
- Palaniappan, S., Sastry, S.K. and Richter, E.R. (1992) Effects of electroconductive heat treatment and electrical pre-treatment on thermal death kinetics of selected microorganisms. *Biotechnology and Bioengineering*, **39**: 225–232.
- Pandit, R.B., Tang, J., Liu, F., Mikhaylenko, G. (2007) A computer vision method to locate cold spots in foods in microwave sterilization processes. *Pattern Recognition*, **40**: 3667–3676.
- Parrot, D.L. (1992) Use of OH for aseptic processing of food particulates. *Food Technology*, **45**: 68–72.
- Peleg, M. (2004) Analyzing the effectiveness of microbial inactivation in thermal processing, in *Improving the Thermal Processing of Foods* (ed. P. Richardson). Woodhead Publishing Ltd, Cambridge, UK, pp. 411–426.
- Pereira, R.N., Martins, R.C., Mateus, C and Vicente, A.A. (2007) Death kinetics of *E.coli* in goat milk and *Bacillus licheniformis* in cloudberry jam heated by ohmic heating. *Chemical Papers*, **61**(2): 121–126.
- Pereira, R.N., Martins, R.C. and Vicente, A.A. (2008) Goat milk free fatty acid characterization during conventional and ohmic heating pasteurization. *Journal of Dairy Science*, **91**: 2925–2937.
- Pitchai, K., Birla, S.L., Jones, D. and Subbiah, J. (2012) Assessment of heating rate and non-uniform heating in domestic microwave ovens. *Journal of Microwave Power and Electromagnetic Energy*, **46**(4): 229–240.
- Piyasena, P., Dussault, C., Koutchma, T. *et al.* (2003) Radio frequency heating of foods: Principles, applications and related properties – a review. *Critical Reviews in Food Science and Nutrition*, **43**: 587–606.
- Proctor, A. (2011) *Alternatives to Conventional Food Processing*. RCS Publishing, London.
- Ramaswamy, H., Koutchma, T. and Tajchakavit, S. (2000) Enhanced thermal effect under microwave heating conditions. International Conference of Engineering and Food (ICEF-8), Puebla, Mexico.
- Rowley, AT. (2000) Radio frequency heating, in *Thermal Technologies in Food Processing* (ed. P.S. Richardson). Marcel Dekker, NY, pp. 567–588.
- Ruan, R. Ye, X., Chen, P. *et al.* (2004) Developments in ohmic heating, in *Improving the Thermal Processing of Foods* (ed. P. Richardson). Woodhead Publishing Ltd, Cambridge, UK, pp. 224–252.

- Ruhlman, K.T., Jin, Z.T. and Zhang, Q.H. (2001) Physical properties of liquid foods for pulsed electric field treatment, in *Pulsed Electric Fields in Food Processing* (eds V. Barbosa-Canovas and Q.H. Zhang). Technomic Publishing Co., Lancaster, PA, pp. 45–56.
- Rzepecka, M.A. and Pereira, R.R. (1974) Permittivity of some dairy products at 2450 MHz. *Journal of Microwave Power*, **40**: 277–288.
- Salazar-González, C., Martín-González, M.F.S., López-Malo, A. and Sosa-Morales, M.E. (2012) Recent studies related to microwave processing of fluid foods. *Food Bioprocessing and Technology*, **5**(1): 31–46.
- Samaranayke, C.P. and Sastry, S.K. (2005). Electrode and pH effects on electrochemical reactions during ohmic heating. *Journal of Electroanalytical Chemistry*, **577**(1): 125–135.
- Sarkar, S. (2006) Shelf-life extension of culture milk products. *Nutrition & Food Science*, **36**: 24–31.
- Sastry, S. (2005) Electrical conductivity of foods, in *Engineering Properties of Foods* (eds M.A. Rao, S.S.H. Rizvi and A. Datta). Taylor and Francis, pp. 461–500.
- Sastry, S.K. and Palaniappan, S. (1992) Ohmic heating of liquid-particle mixtures. *Food Technology*, **46**(12): 64–67.
- Sato M. (2009) Food for microwave oven heating use. Japanese Patent JP 2009247325.
- Schubert, H. and Regier, M. (2005) *The Microwave Processing of Foods*. CRC Press, Boca Raton/Boston/NY.
- Sieber, R., Eberhard, P., Fuchs, D. *et al.* (1996) Effect of microwave heating on vitamins A, E, B₁, B₂ and B₆ in milk. *Journal of Dairy Research*, **63**: 169–72.
- Sierra, I. and Vidal-Valverde, C. (2000) Influence of heating conditions in continuous-flow microwave or tubular heat exchange systems on the vitamin B1 and B2 content of milk. *Lait*, **80**: 601–608.
- Sierra, I., Vidal-Valverde, C. and Olano, A. (1999) The effects of continuous flow microwave treatment and conventional heating on the nutritional value of milk as shown by influence on vitamin B1 retention. *European Food Research and Technology*, **209**: 352–354.
- Sochanski, J.S., Goyette, J., Bose, T.K. *et al.* (1990) Freeze dehydration of foamed milk by microwaves. *Drying Technology*, **895**: 1017–1037.
- Sosa-Morales, M.E., Valerio-Junco L., López-Malo, A. and García, H.S. (2010) Dielectric properties of foods: Reported data in the 21st Century and their potential applications. *LWT – Food Science and Technology* **43**: 1169–1179.
- Souda, B., Akyel, K. and Bilgen, E. (1989). Freeze dehydration of milk using microwave energy. *Journal of Microwave Power and Electromagnetic Energy*, **24**: 195–202.
- Stancl, J. and Zitny, R. (2010) Milk fouling at direct ohmic heating. *Journal of Food Engineering*, **99**: 437–444.
- Stearns, G. and Vasavada, P.C. (1986) Effect of microwave processing on quality of milk. *Journal of Food Protection*, **48**: 853.
- Stehle, G. (1980) Pasteurization and sterilization of Camembert cheese in flexible packs. *Deutsche Molkerei-Seitung*, **101**: 1422, 1424–1426.
- Sumnu, S.G. and Sahin, S. (2012) Microwave heating, in *Thermal Food Processing: New Technologies and Quality Issues*, 2nd edn (ed. D.-W. Sun). Taylor and Francis, London, pp. 529–582.
- Sun, H., Kawamura, S., Himoto, J. *et al.* (2008) Effects of ohmic heating on microbial counts and denaturation of proteins in milk. *Food Science and Technology Research*, **14**: 117–123.

- Tamine, A. (2009) *Milk Processing and Quality Management*. John Wiley & Sons, Inc., Hoboken, NJ.
- Tang, J. (2005) Dielectric properties of foods, in *The Microwave Processing of Foods* (eds H. Schubert and M. Regier). Woodhead Publishing Ltd, Cambridge, UK, pp. 22–40.
- Tajchakavit, S. and Ramaswamy, H. (1995) Continuous-flow microwave heating of orange juice: Evidence of non-thermal effects. *Journal of Microwave Power and Electromagnetic Energy* **30**: 141–148.
- Tessler, F.J., Gadonna-Widehem, P. and Laguerre, J.-C. (2006) The fluorimetric FAST method, a simple tool for the optimization of microwave pasteurization of milk. *Molecular Nutrition & Food Research*, **50**: 793–798.
- Tewari, G. and Juneja, V.K. (eds) (2007) *Advances in Thermal and Non-thermal Food Preservation*. Blackwell Publishing, IA,
- Tham, H.J., Chen, X.D. and Young, B. (2006) Ohmic heating of dairy fluids – A review, in *Chemeca 2006: Knowledge and Innovation*. [Auckland, N.Z.]: Engineers Australia, 2006. Availability: <<http://search.informit.com.au/documentSummary;dn=269309001398919;res=IELENG>> ISBN: 0868691100 (last accessed 29 December 2014), pp. 1095–1099.
- Tham, H.J., Chen, X.D., Young, B. and Duffy, G.G. (2009) Ohmic heating of dairy fluid – effect of local electrical fields on temperature distribution. *Asia Pacific Journal of Chemical Engineering*, **4**(5): 751–758.
- Tochman, L.M., Stine, C.M. and Harte, B.R. (1985) Thermal treatment of cottage cheese ‘in-package’ by microwave heating. *Journal of Food Protection*, **48**: 932–938.
- Uprit, S. and Mishra H.N. (2004) Microwave heating and its effect on keeping quality of soy fortified paneer. *Egyptian Journal of Dairy Science*, **32**: 269–276.
- Valero, E., Villamiel, M., Sanz, J. and Martinez-Castro, I. (2000) Chemical and sensorial changes in milk pasteurised by microwave and conventional systems during cold storage. *Food Chemistry*, **70**: 77–81.
- Vasavada, P.C. (1990) Microwave processing for the dairy industry. *Food Australia*, **42**: 562–564.
- Vasavada, P.C., Bastian, E.D. and Marth, E.H. (1995) Chemical and functional changes in milk caused by heating in water bath or microwave-oven. *Milchwissenschaft*, **53**: 553–556.
- Vasson, M.P., Farges, M.C., Sarrret, A. and Cynober, L. (1998) Free amino acid concentrations in milk: effects of microwave versus conventional heating. *Amino Acids* **15**: 385–388.
- Venkatesh, M.S. and Raghavan, G.S.V. (2004) An overview of microwave processing and dielectric properties of agri-food materials. *Biosystems Engineering*, **88**(1): 1–18.
- Vernam, A.H. and Sutherland, J.P. (1994) *Milk and Milk Products: Technology, Chemistry and Microbiology*. Chapman & Hall, London.
- Vicente, A. and Castro, I.A. (2007) Novel thermal processing technologies, in *Advances in Thermal and Non-thermal Food Preservation* (eds G. Tewari and V.K. Juneja). Blackwell Publishing, IA, pp. 99–130.
- Vicente, A.A., Castro, I. and Teixeira, J.A. (2006) Ohmic heating for food processing, in *Thermal Food Processing: New Technologies and Quality Issues* (ed. D.-W. Sun). Taylor and Francis, London, pp. 425–468.
- Vicente, A.A., Castro, I., Teixeira, J.A. and Pereira, R.N. (2012) Ohmic heating for food processing, in *Thermal Food Processing: New Technologies and Quality Issues*, 2nd edn (ed. D.-W. Sun). Taylor and Francis, London, pp. 460–500.

- Vadivambal, R. and Jayas, D.S. (2010) Non-uniform temperature distribution during microwave heating of food materials-A review. *Food Bioprocess Technology*, **3**: 161–171.
- Vidal-Valverde, C. and Redondo, P. (1993) Effect of microwave heating on the thiamine content of cows' milk. *Journal of Dairy Research*, **60**: 259–262.
- Villamiel, M., López-Fandiño, R. and Olano, A. (1996) Microwave pasteurization of milk in continuous flow unit: shelf life of cow's milk. *Milchwissenschaft*, **51**: 674–677.
- Villamiel, M., Schutyser, M.A.I. and de Jong, P. (2009) Novel methods of milk processing, in *Milk Processing and Quality Management* (ed. A. Tamime). John Wiley & Sons, Inc., Hoboken, NJ, pp. 205–236.
- Wang, W. and Guohua, C. (2005) Heat and mass transfer model of dielectric material assisted microwave freeze drying of skim milk with hygroscopic effect. *Chemical Engineering Science*, **60**: 6542–6550.
- Wang, Y., Wig, T.D., Tang, J. and Hallberg, L.M. (2003a) Dielectric properties of foods relevant to RF and microwave pasteurization and sterilization. *Journal of Food Engineering*, **57**: 257–268.
- Wang, Y., Wig, T.D., Tang, J. and Hallberg, L.M. (2003b) Sterilization of foodstuffs using radio frequency heating. *Journal of Food Science*, **68**(2): 539–544.
- Zhao, Y. (2006) Radio frequency dielectric heating, in *Thermal Food Processing: New Technologies and Quality Issues* (ed. D.-W. Sun). Taylor and Francis, London, pp. 469–492.
- Zhao, Y. and Ling, Q. (2012) Radio frequency dielectric heating, in *Thermal Food Processing: New Technologies and Quality Issues*, 2nd edn (ed. D.-W. Sun). Taylor and Francis, London, pp. 501–528.
- Zhu, J., Kuznetsov, A.V. and Sandeep, K.P. (2007) Mathematical modelling of continuous flow microwave heating of liquids (effects of dielectric properties and design parameters). *International Journal of Thermal Sciences*, **46**: 328–341.

3

High-Pressure Processing of Milk and Dairy Products

Daniela D. Voigt¹, Alan L. Kelly¹, and Thom Huppertz²

¹*School of Food and Nutritional Sciences, University College Cork, Ireland*

²*NIZO food research, Ede, The Netherlands*

3.1 Introduction to High-Pressure Processing

Traditionally, food is preserved by heat treatment to achieve inactivation of undesirable microbes and give an acceptable shelf life. However, high temperatures can adversely affect the flavour and nutritional value of some foods; for example, through Maillard browning or destruction of vitamins. Thus, a number of nonthermal technologies have been studied in recent years; for example, high-pressure (HP) treatment, pulsed electric fields, ionization radiation and ultrasonication (Ross *et al.*, 2003). Of these, HP processing probably represents the most promising new possibility for preserving and preparing food products with improved functional and microbiological properties. HP technology for application to food products was first reported by Hite (1899), who observed that HP treatment significantly increased the shelf life of raw milk. Since then, it has been established that HP usually has little negative effect on flavour compounds, colour, vitamins and other nutrients and, hence, does not affect the nutritional and organoleptic properties of the product, thus offering significant advantages compared to thermal processing of food (Rastogi *et al.*, 2007).

Two basic principles apply in HP processes, namely Le Chatelier's principle and the Isostatic principle. The former states that 'if a change in conditions is imposed on a system in equilibrium, the system will react to counteract that change and restore the equilibrium'. The Isostatic principle states that the hydrostatic pressure process is volume-independent; therefore, pressure can be applied instantaneously and uniformly throughout a sample, and pressure gradients do not exist, so that the size and geometry of the product is irrelevant. This is another benefit of HP-processed food, compared to heat-processed food, where different thicknesses lead to overheating at

the surface and to inadequate temperatures in the centre of the product, which can lead to survival of food-borne bacteria. It is possible to process liquid and solid foods by HP; only food products with large quantities of air are not suitable, because their structure would be destroyed.

HP units consist of (1) the cylindrical pressure vessel plus closure, (2) a pressure-generating system, including pumps/intensifiers, (3) pressure-transmitting medium, (4) temperature control device and (5) material handling systems (San Martín-González *et al.*, 2006). All materials used have to be able to withstand the extreme pressures applied and, for this reason, special technologies need to be applied in their manufacture.

The pressures of interest for processing of food products are in the range 100–1000 MPa (or 1000–10 000 bar). Nowadays, HP units are available that can treat product volumes from 35–687 litres of product. Key HP treatment parameters are temperature, pressure and holding time. In the food industry, pressures should be ideally below 420 MPa, as this lowers the initial investment cost for equipment (Buzrul *et al.*, 2008). The current pressure limit for commercial-scale pressure vessels is 680 MPa. Generally, it can be said that pressures below 420 MPa result in similar levels of inactivation of bacteria to those found for pasteurization, while pressures over 700 MPa are required for sterilization of the product (Torres and Velazquez, 2005).

The pressure-transmitting medium may be water, or a mixture of oil or alcohol, depending on the system being used. As a result of adiabatic heating, the temperature increases during pressurization, by up to 2–3°C per 100 MPa for water. Similar temperature increases, of up to 2.7°C per 100 MPa, were reported for whole milk (Buzrul *et al.*, 2008). To avoid any unnecessary heat-induced damage of the product, the pressure vessel is temperature controlled.

One potential disadvantage for the pressurization of solid food is the fact that the product has to be loaded onto the HP unit, pressure treated and reloaded before the next batch can be treated. However, due to the increased size and vessel capacity of the new generation HP units, it is now possible to treat up to 600 litres of product in a semi-continuous process (NC Hyperbaric, Burgos, Spain). Over the past few years, the number of commercial HP units sold increased steadily. Beside the initial investment costs, the maintenance costs are high. However, for successful commercial applications of HP treatment, these are outweighed by the added value, the increased shelf life and safety of the food product (Rastogi *et al.*, 2007).

In 1990, the first commercial food products treated with HP were introduced on the Japanese market and, by 2003, these numbers had multiplied significantly. HP is consistent with the demand of modern consumers for healthy, additive-free and minimally-treated food products (Smith *et al.*, 2009) with an adequate shelf life. HP treatment is being used today in various countries (Spain, USA, Italy, Japan, Germany, Mexico, Canada and Australia) for a number of meat, seafood, juice and vegetable products (Table 3.1). Applications of HP treatment for dairy products have, thus far, been slow to appear commercially, which is discussed later.

Up to now, HP technology has been limited to pasteurization processes for commercial use, due to the HP-resistance of microbial spores. However, if elevated temperatures between 60 and 90°C are applied, both bacterial cells and spores can be inactivated, using adiabatic compression for rapid heating (Matser *et al.*, 2004).

Table 3.1 High-pressure treated products on the international market

Product group	Product	Company	Country
Dairy products	COL+ Colostrum	New Image Natural Health Limited	NZ
	Cheese sandwich filling	Rodilla	Spain
	Soya products	Toby's	USA
Meat products	Cured smoked ham	Abraham	Germany
	Slice cooked ham	Espuna Co.	Spain
	Sliced ham and cured meats	Santa Maria Foods	Canada
	Chicken sausages	Lou Famous	USA
	Preservative-free chicken strips	Purdue Farms	USA
	Processed poultry products	Purdue Farms	USA
	Sliced and diced poultry products	Tyson Foods	USA
	Ready-to-eat sliced meats	Hormel, Kraft	USA
Seafood products	Sliced, cured and marinated meat	Campofrio	Spain
	Oysters	Motivatit Seafood, Goose Point Oysters, Joey Oysters	USA
	Lobsters	Clearwater, Ocean Choice, Seafood 2000	Canada
	Crab	Phillips Seafood	USA
	Desalted Cod	Ghezzi	Italy
Vegetables and fruits	Guacamole	Avomex, Freshurized Foods	USA
	Tomato sauces	SimplyFresco	USA
	Avocado products	San Lorenzo	Mexico
	Humus	Calavo	USA
Juices and beverages	Juice	Hannah International	USA
		Pernod Ricard, Pampryl, Ultifruit	France
		Hormel Foods	USA
		Beskyd Frycovice	Czech Republic
		Danny Boy	Australia
		Leahy Orchards	Canada
		Frubaca	Portugal
Others		Ata	Italy
	RTE meals and salads	Maple Leaf	Canada

Source: Kelly, *et al.*, 2009. Reproduced with permission of Elsevier.

3.2 Effects of High Pressure on Food Constituents: Basic Considerations

To understand and use the effects of HP on constituents and properties of milk, it is first important to consider the effects of HP on basic physical and chemical equilibria. When pressure is applied to a product, equilibria are disturbed. As described by Le Chatelier's principle, when the volume of the system is reduced, it will re-equilibrate by suppressing reactions involving an increase in volume, while promoting those involving a reduction in volume. For aqueous systems, volume changes are primarily related to the organization of the molecules of water, which is compressed by about 4% at 100 MPa or 15% at 600 MPa (Hinrichs *et al.*, 1996). Compression is accompanied by: generation of heat (2–3°C per 100 MPa of applied pressure) (Balci and Wilbey, 1999); a decrease in freezing point, to –8 or –22°C at 100 or 210 MPa, respectively (Hinrichs, *et al.*, 1996); and a reduction in pH, by about 1 unit at 1000 MPa (Marshall and Frank, 1981).

Ionization reactions are favoured under HP because organization of water molecules around charged ions is considerably more compact than around the uncharged salts (Stippl *et al.*, 2005). This electrostrictive effect strongly impacts on the mineral balance of milk. With respect to proteins, the volume changes associated with interactions of proteins are primarily due to changes in the compactness of arrangement of water around the proteins, rather than properties of the protein itself (Hvidt, 1975). The primary structure of proteins remains intact during HP treatment because covalent bonds are not affected (Mozhaev *et al.*, 1994), but changes in secondary structure lead to irreversible denaturation at HP, because stabilizing hydrogen bonds are enhanced at low pressures and ruptured only at very high pressures (Hendrickx *et al.*, 1998). Significant changes to the tertiary structure of proteins, which is maintained by hydrophobic and ionic interactions, are observed at >200 MPa (Hendrickx *et al.*, 1998). This is exemplified by the association of β -casein, which is at a minimum at about 150 MPa, above which it increases again (Payens and Heremans, 1969).

3.3 Effects of High Pressure on the Constituents of Milk

3.3.1 Milk Salts

When milk is pressurized, mineral solubility increases due to favoured solvation of ions. For the sodium and potassium salts this is of limited importance, as they are already fully soluble under physiological conditions. However, milk contains far more calcium and magnesium phosphate than is soluble under physiological conditions and the insoluble fraction, that is about 70, 30 and 50% of all calcium, magnesium and inorganic phosphate, respectively, is found in the caseins micelles and referred to as micellar calcium phosphate (MCP).

Increased solubility of salts in milk under HP is highlighted by the increased solubility of MCP (Hubbard *et al.*, 2002; Huppertz and De Kruif, 2007a). Solubilization of MCP increases with increasing pressure up to about 400 MPa, where all MCP is solubilized in unconcentrated milk at neutral pH and ambient temperature (Huppertz

and De Kruif, 2007a), but solubility reverses rapidly on release of pressure (Hubbard *et al.*, 2002). Higher levels of nonsedimentable calcium and phosphorus in HP-treated milk than in untreated milk have previously been reported (Lopez-Fandino *et al.*, 1998; Schrader and Buchheim, 1998; Regnault *et al.*, 2006). However, these findings cannot be taken as a measure of HP-induced solubilization of MCP persisting after decompression, since levels of ultrafiltrable calcium and inorganic phosphate are not affected by HP treatment of milk (Regnault *et al.*, 2006). The HP-induced increase in nonsedimentable calcium and inorganic phosphate in milk is due to an increased level of nonsedimentable protein-bound calcium and inorganic phosphate. Small increases in the concentration of ionic calcium in milk have been observed immediately post-HP treatment (Lopez-Fandino *et al.*, 1998; Zobrist *et al.*, 2005; Knudsen and Skibsted, 2009) but revert readily on subsequent storage (Zobrist *et al.*, 2005; Knudsen and Skibsted, 2009).

3.3.2 Milk Fat and Milk Fat Globules

Few studies have considered HP-induced changes in milk fat and milk fat globules. HP treatment of milk at 100–600 MPa at <40°C does not affect fat globule size in milk (Gervilla *et al.*, 2001; Huppertz *et al.*, 2003; Ye *et al.*, 2004) or cream (Dumay *et al.*, 1996; Kanno *et al.*, 1998) but treatment of cream at 800 MPa for 10 minutes increased fat globule size in cream (Kanno *et al.*, 1998). HP treatment of milk also induced the association of β -lactoglobulin (at >100 MPa), α -lactalbumin (at \geq 700 MPa) and κ -casein (at >500 MPa) with the milk fat globule membrane (MFGM) (Ye *et al.*, 2004). Treatment up to 800 MPa results in some aggregation, but no rupture, of the MFGM (Kanno *et al.*, 1998). Fat crystallization in HP-treated cream occurs at a higher temperature than in untreated cream (Buchheim and Abou El-Nour, 1992), due to a HP-induced increase in the solid/liquid transition temperature of milk fat (Frede and Buchheim, 2000). Improved whipping properties of cream, that is reduced whipping time and reduced serum loss, were observed following HP treatment (500–600 MPa for 1–2 min) of cream and were related to the enhanced crystallization of milk fat (Eberhard *et al.*, 1999). Furthermore, improved crystallization of milk fat in HP-treated cream was also suggested to have potential applications in ageing/ripening of ice cream mix and cream for butter making (Buchheim and Abou El-Nour, 1992; Dumay *et al.*, 1996; Frede and Buchheim, 2000). HP treatment (400 MPa for 4 h at 45°C) of the hard (high melting) fraction of milk fat also significantly suppresses thermal deterioration (Abe *et al.*, 1999).

Creaming of fat globules on cold storage is greater in (unhomogenized) milk treated at 100–250 MPa than in untreated milk, whereas treatment at >400 MPa significantly reduces creaming (Huppertz *et al.*, 2003). Treatment at 100–250 MPa appears to promote the cold agglutination of milk fat globules, as a result of which clusters of fat globules form on cold storage and faster creaming occur. Reduced cold agglutination, and hence reduced creaming, after treatment at >400 MPa occurs as a result of HP-induced denaturation of immunoglobulins.

3.3.3 Whey Proteins

Treatment of milk at up to 100 MPa does not denature β -lactoglobulin (β -lg) but treatment at higher pressures results in considerable denaturation of β -lg, up to about 90%

of the total β -lg in milk treated at ≥ 400 MPa (Lopez-Fandino *et al.*, 1996; Gaucheron *et al.*, 1997; Scollard *et al.*, 2000a; Huppertz *et al.*, 2004a, 2004b). Denaturation of α -lactalbumin (α -la) only occurs at ≥ 400 MPa, and reaches about 70% after 30 minutes at 800 MPa (Huppertz *et al.*, 2004a, 2004b). The extent of HP-induced denaturation of α -la and β -lg increases with treatment time (Scollard *et al.*, 2000a; Hinrichs and Rademacher, 2004; Huppertz *et al.*, 2004a), treatment temperature (Gaucheron *et al.*, 1997; Lopez-Fandino and Olano, 1998; Garcia-Risco *et al.*, 2000; Huppertz *et al.*, 2004a), milk pH (Arias *et al.*, 2000; Huppertz *et al.*, 2004a) and the level of MCP in the milk (Huppertz *et al.*, 2004b). HP-induced denaturation of whey proteins is largely prevented in the presence of sulfhydryl-blocking agents (Huppertz *et al.*, 2004b) and is considerably more extensive in milk than in cheese whey (Huppertz *et al.*, 2004b). Milk solids concentration has relatively little effect on the HP-induced denaturation of whey proteins (Anema, 2008). HP-induced denaturation of whey proteins and their association with the casein micelles is irreversible on subsequent storage of milk (Huppertz *et al.*, 2004c).

Part of the denatured β -lg in HP-treated milk has been shown to be associated with the casein micelles (Gaucheron *et al.*, 1997; Scollard *et al.*, 2000b; Garcia-Risco *et al.*, 2003). When a high centrifugal force, that is $100\,000\times g$, is used for fractionation, the majority of denatured β -lg in HP-treated skimmed milk is associated with the sedimented casein micelles, with a small proportion remaining nonsedimentable, either in the form of whey protein aggregates or associated with casein particles too small to be sedimented (Gaucheron *et al.*, 1997; Huppertz *et al.*, 2004a; Zobrist *et al.*, 2005). At lower centrifugal force, that is $25\,000\times g$, most whey protein remained in the supernatant of HP-treated concentrated milk (Anema, 2008). In HP-treated whole milk, denatured α -la and β -lg are also found associated with the MFGM (Ye *et al.*, 2004).

Huppertz *et al.* (Huppertz *et al.*, 2004b) described the following mechanism for HP-induced denaturation of α -la and β -lg in milk and whey. Under HP, β -lg unfolds (Kuwata *et al.*, 2001), which results in the exposure of the free sulfhydryl group of β -lg (Tanaka *et al.*, 1996; Moller *et al.*, 1998; Stapelfeldt *et al.*, 1999), which can interact with κ -casein, α -la or β -lg, and possibly α_2 -casein, through sulfhydryl-disulfide interchange reactions. In this process, calcium facilitates close approach of proteins through charge shielding (Huppertz *et al.*, 2004b). On release of pressure, unfolded α -la and β -lg molecules that have not interacted with another protein may refold to a state closely related to that of native β -lg (Belloque *et al.*, 2000; Ikeuchi *et al.*, 2001).

Compared to α -la and β -lg, HP-induced denaturation of other whey proteins has received little attention. No denaturation of bovine serum albumin occurred in milk treated at 100–400 MPa (Lopez-Fandino *et al.*, 1996). The immunoglobulins are also relatively stable to HP processing, with about 90% of colostrum immunoglobulin G remaining native after treatment for five minutes at 500 MPa (Indyk *et al.*, 2008).

3.3.4 Casein Micelles

When skimmed milk is placed under pressure, disruption of the casein micelles occurs (Kromkamp *et al.*, 1996; Gebhart *et al.*, 2005; Huppertz *et al.*, 2006a, 2006b; Huppertz and De Kruif, 2006, 2007b; Orlien *et al.*, 2006; Huppertz and Smiddy, 2008). Micellar disruption under pressure increases with pressure, up to about 400 MPa (Kromkamp *et al.*, 1996; Huppertz *et al.*, 2006a, 2006b; Orlien *et al.*, 2006) and proceeds faster at higher pressures (Kromkamp *et al.*, 1996; Huppertz *et al.*, 2006b; Orlien *et al.*, 2006). Reducing temperature (Orlien *et al.*, 2006) or pH (Huppertz and De Kruif, 2006) also

increases the extent of HP-induced disruption of casein micelles, whereas whey proteins do not affect HP-induced disruption of casein micelles (Huppertz and De Kruijff, 2007b). The primary factor inducing micellar disruption under HP is solubilization of MCP (Huppertz and De Kruijff, 2006). When casein micelles are held for prolonged times at 200–300 MPa, the initial disruption of casein micelles is followed by a reformation process, during which casein particles are formed (Huppertz *et al.*, 2006b; Huppertz and De Kruijff, 2006, 2007b; Orlien *et al.*, 2006; Huppertz and Smiddy, 2008). Reformation is more extensive at higher temperatures (Orlien *et al.*, 2006) and higher pH (Huppertz and De Kruijff, 2006) and is not influenced by the presence of whey proteins (Huppertz and De Kruijff, 2007b). Reformation of casein particles is further promoted on release of pressure (Kromkamp *et al.*, 1996; Huppertz *et al.*, 2006b).

As a result of the aforementioned changes in casein micelles during HP treatment, casein micelles in HP-treated milk differ from those in untreated milk in terms of size distribution and sedimentation behaviour. Casein micelle size is affected little by treatment at pressures <200 MPa, but treatment at 250–300 MPa for >15 minutes can result in considerable increases in micelle size (Gaucheron *et al.*, 1997; Needs *et al.*, 2000; Huppertz *et al.*, 2004d, 2004e; Regnault *et al.*, 2004; Anema *et al.*, 2005a; Anema, 2008). This increase in micelle size is far greater when treatment is carried out at higher temperature (Gaucheron *et al.*, 1997; Huppertz *et al.*, 2004b; Anema *et al.*, 2005b) or higher pH (Huppertz *et al.*, 2004d). HP-induced increases in casein micelle size are, at least partially, reversible on subsequent storage of the milk (Huppertz *et al.*, 2004d). Treatment of milk at 300–800 MPa reduces casein micelle size, to approximately half of that in untreated milk (Gaucheron *et al.*, 1997; Needs *et al.*, 2000; Huppertz *et al.*, 2004d, 2004e; Regnault *et al.*, 2004; Anema *et al.*, 2005a; Anema, 2008). However, when treatment at 300–400 MPa is performed at >40°C, micelle size is considerably higher (Garcia-Risco *et al.*, 2000; Huppertz *et al.*, 2004d; Anema *et al.*, 2005a). HP-induced reductions in casein micelle size are irreversible on subsequent storage (Huppertz *et al.*, 2004d). When concentrated skimmed milk (20% w/w) is treated at 300 MPa for 30 minutes, an increase rather than a decrease in micelle size is observed (Anema, 2008).

HP-induced changes in casein micelle size are accompanied by changes in the turbidity and lightness of skimmed milk. These optical parameters are affected little by treatment at 100–200 MPa but decrease strongly on treatment at 200–400 MPa; at higher pressures, little further effect is observed (Needs *et al.*, 2000; Huppertz *et al.*, 2004e; Regnault *et al.*, 2004). HP treatment also increases the level of nonmicellar caseins considerably, with a maximum increase at 250–300 MPa (Lopez-Fandino *et al.*, 1998; Huppertz *et al.*, 2004d); the extent of HP-induced dissociation was reported to be β -casein > κ -casein > α_{s1} -casein > α_{s2} -casein (Lopez-Fandino *et al.*, 1998). HP-induced increases in the levels of nonmicellar caseins are partially irreversible on subsequent storage at 5°C, but reverse rapidly at 20°C (Huppertz *et al.*, 2004d).

3.3.5 Milk Enzymes

When considering the effects of HP on milk enzymes, the effects on plasmin and lipase are of particular technological relevance. During the thermal treatment commonly applied to milk, the lipoprotein lipase indigenous to milk is readily inactivated. However, lipoprotein lipase in milk is resistant to treatment at pressures up to at least 400 MPa (Pandey and Ramaswamy, 2004), suggesting that if HP treatment of milk is applied without a combination with a thermal treatment, residual active lipoprotein

lipase may remain and the shelf life of milk products will be reduced significantly because of lypolysis.

The effects of HP on plasmin have been studied in somewhat greater detail. Treatment of milk at a pressure up to about 300 MPa has little effect on plasmin activity in milk but at higher pressures considerable inactivation is observed, that is up to about 75% inactivation following 30 minutes at 600 MPa (Scollard *et al.*, 2000b; Huppertz *et al.*, 2004f). In buffers, plasmin shows considerably higher barostability and can be treated at 800 MPa without notable inactivation (Scollard *et al.*, 2000a). The inclusion of β -lg in the buffer system reduces the barostability of plasmin considerably (Scollard *et al.*, 2000a). This suggests that HP-induced inactivation of plasmin is likely to be due to the complexation with β -lg, probably through sulfhydryl-disulfide interchange reactions. HP treatment affects proteolysis of milk through inactivation of plasmin but also through its effects on casein micelles. During storage at 37°C, the breakdown of β -casein was most extensive in milk treated at 300 or 400 MPa, despite some HP-induced inactivation of plasmin having occurred (Huppertz *et al.*, 2004f). This strongly suggests that the disruption of casein micelles facilitates the proteolysis of caseins by the residual active plasmin.

3.3.6 Viscosity and Rheological Properties

Predominantly as a result of the HP-induced changes in the milk proteins, the rheological properties of HP-treated milk differ considerably from those of untreated milk. For unconcentrated skimmed milk, viscosity increases slightly, but steadily, with increasing pressure (Desobry-Banon *et al.*, 1994; Huppertz *et al.*, 2003). These increases in viscosity are most likely the result of the disruption of casein micelles and denaturation of whey proteins. Considerably larger increases in viscosity are observed when milk is concentrated prior to HP treatment (Velez-Ruiz *et al.*, 1998). Particularly at a solids content >300 g/kg, the viscosity of milk treated at >400 MPa increases very strongly with increasing milk solids content. In extreme cases, this can even lead to gelation of milk (Keenan *et al.*, 2001). The microstructure of milk systems gelled by HP treatment commonly resembles that of a proteinaceous network of micellar fragments, which are commonly an approximate order of magnitude smaller than the original casein micelles (Keenan *et al.*, 2001). HP-induced gelation of milk is promoted by a reduction in solvent quality, as a result of the addition of sucrose or salts, but is prevented when the casein is in a non-micellar state, for example as sodium caseinate or through disruption by the addition of ethylenediaminetetraacetic acid (EDTA), whereas whey protein denaturation does not affect the HP-induced gelation of milk (Keenan *et al.*, 2001).

3.4 Effects of High Pressure on Dairy Microbiology

As stated earlier, one of the main reasons for the application of HP on food products, besides altering functional and textural properties, is the inactivation of spoilage bacteria (Rendules *et al.*, 2011). The effect of HP on milk has been reviewed extensively (Trujillo *et al.*, 2002; López-Fandiño, 2006; Kelly *et al.*, 2008). Treatment at 400 MPa for 15 minutes or 500 MPa for three minutes was necessary to obtain the same shelf life as pasteurized milk (10 days at 10°C) (Rademacher and Kessler, 1997). HP treatment

Table 3.2 Inactivation of various microorganisms in milk and structural and functional changes in cells at different pressures

Pressure (MPa)	Effect of HP on microorganisms in milk	Effect of HP on cells
500	6.5 log reduction of <i>E.coli</i> 3.8 log reduction of <i>L. innocua</i>	
300	Complete inactivation of <i>P. fluorescens</i> DSM 4358	Irreversible protein denaturation Leakage of cell contents
200		Membrane damage Signs of cell contents leakage
100		Reversible protein denaturation Compression of gas vacuoles
50		Reduction in the number of ribosomes Inhibition of protein synthesis
0.1		Atmospheric pressure

Source: Adapted from Lado and Yousef, 2002; Black *et al.* 2005.

decreases the number of live microorganisms in milk, due to the denaturation of critical enzymes, and increases permeability of the cellular membrane, which is responsible for the nutrient and respiration transport mechanisms of the cell. With modified permeability, the cellular wall loses its transport function, which leads to a loss of nutrients and the complete death of the cell. The actual inactivation of microorganisms is due to various reactions of the cell under HP (Table 3.2).

The level of microbial inactivation depends on the pressure applied, duration of treatment (holding time), temperature, environment and number and types of microbes. Sensitivity to pressure can change depending on the growth phase of the microbe. In general, cells in the exponential phase of growth are less resistant to pressure than cells that are in a stationary phase of growth. Thus, technologically, it represents a potential pasteurization alternative to heat treatment. Yeasts, moulds and most vegetative bacteria are inactivated by pressures between 300 and 600 MPa. Only bacterial spores survive pressures over 1000 MPa but, if germinated at 50 to 300 MPa, spores can be inactivated by mild pressure or heat treatment (Smelt, 1998). In addition, it has also been reported that milk constituents undergo numerous changes, which cause modifications on the quality and functionality of milk.

3.5 HP Treatment and Cheese

Cheese manufacture involves the preparation and coagulation of milk, followed by further handling of the curd, depending on cheese variety. Milk for cheese manufacture is usually pasteurized to avoid the spread of diseases linked to pathogens such as *Listeria monocytogenes*. High temperatures, however, can adversely affect the compositional, nutritional and sensory attributes of milk, and in the case of cheese there is strong evidence that cheese made from raw milk has a more complex and rich flavour than that made from pasteurized milk. Raw milk cheese can pose a significant health

risk due to pathogen contamination; in addition, the development of unwanted secondary flora could result in the decreased shelf life of the cheese.

Over the past few decades, a variety of novel methods have been investigated to achieve the same reduction of unwanted bacteria in milk as pasteurization, without negative effects on the quality of milk, that is impairment of the flavour of milk upon pasteurization, including HP processing (Linton *et al.*, 2008). HP treatment applied to cheese could significantly reduce the risk of infection of humans by pathogens and help to control the cheese microflora. In general, the effect of HP on microflora of the manufactured cheese depends on cheese type, composition and maturity (Kolakowski *et al.*, 1998).

A Japanese patent (Yokohama *et al.*, 1992) reported that it was possible to reduce the ripening time of Cheddar cheese to six months by HP treatment for three days at 50 MPa and 25°C. The main objective of this process was to accelerate the long and very expensive ripening process of cheese. Many subsequent studies (Messens *et al.*, 1999; Trujillo *et al.*, 2000; O'Reilly *et al.*, 2001; San Martín-González *et al.*, 2006) have evaluated this possibility for various cheese varieties (Cheddar, ewes' milk, Mozzarella and Gouda cheese); pressures in the range 50–500 MPa, times from five minutes to 72 hours and temperatures between 4 and 25°C have been studied (Table 3.3).

In general, such studies have led to the conclusion that HP was not effective in accelerating cheese ripening. However, it could possibly be used to arrest cheese ripening, as for mature blue-veined cheese, and as such be used to preserve the cheese at its best texture and flavour (Voigt *et al.*, 2010). In Cheddar cheese treated at 500 MPa, lower levels of free amino acids (FAAs) were reported; however, no change in cheese texture could be observed (Wick *et al.*, 2004). Further studies will be necessary to determine the full potential of HP in arresting cheese ripening.

Flavour development in cheese is a complex combination of various primary and secondary reactions (McSweeney and Sousa, 2000; Singh *et al.*, 2003; Marilley and Casey, 2004). Flavour compounds are produced by the hydrolysis of lactose, lipids and protein into numerous flavour compounds. The degree of hydrolysis is determined by the activities of the starter bacteria, enzymes from the milk, rennet and secondary flora (e.g. in Blue/Camembert cheese).

There have been many studies on the impact of HP on the complex biochemistry of cheese ripening. The effect of HP on proteolysis and lipolysis in Cheddar and ovine milk cheese has been studied. In Cheddar cheese, HP-treated one day post-manufacture, the breakdown of α_{s1} -casein was more rapid than in control untreated cheese (Rynne *et al.*, 2008). In cheese manufactured from milk HP-treated at 300 or 400 MPa for 10 minutes, hydrolysis of β -CN was significantly increased, as was the level of FAA. Similar results were reported for Cheddar cheese treated at 50 MPa for 72 hours; however, proteolysis in reduced fat and low moisture Mozzarella cheese was largely unaffected by HP (O'Reilly *et al.*, 2000, 2003; Sheehan *et al.*, 2005; Garde *et al.*, 2007; Juan *et al.*, 2007a, 2008; Rynne *et al.*, 2008). Lipolysis, measured by the level of free fatty acids in cheese was decelerated by HP treatment at 400 MPa of caprine cheese (Saldo *et al.*, 2003).

The effect of HP on the flavour development and volatiles in cheese has been studied only by a small number of researchers. Ewe's milk cheese, HP treated one day post-manufacture, showed lower amounts of ketones and aldehydes, whereas cheese HP treated after 15 days of ripening showed similar sensory characteristics to control cheese (Juan *et al.*, 2007b). Other studies have shown lower levels of butyric acid and acetoin in Gouda cheese after HP-treatment between 50 and 400 MPa, but differences

Table 3.3 Effect of various pressure conditions on a selection of cheese varieties

Cheese	Pressure (MPa)	Treatment time (min)	Temperature (°C)	Effect of high-pressure treatment on the cheese	References
Reduced-Fat Mozzarella	400	5	21	Increased levels of nonexpressible serum per gramme protein, decreased lightness, increased greenness and reduced yellowness	Sheehan <i>et al.</i> , 2005
Mozzarella	400	20	25	Increased water-holding capacity	O'Reilly <i>et al.</i> , 2002
Cheddar	400	10	20	Decreased levels of starter bacteria and FFA, delayed NSLAB development, less intense flavour	Rynne <i>et al.</i> , 2008
Cheddar Cheddar	50 200–300	3d –	25 –	No effect on ripening indices Decreased FFA content in cheese	O'Reilly <i>et al.</i> , 2000 Sendra <i>et al.</i> , 2000
Gouda	50–400	–	–	Increased concentrations of butyric acid and acetoin in HP cheese	Butz <i>et al.</i> , 2000
Gouda	50, 225, 400	60	14	Initial effects on cheese texture, however no significant changes were observed after 42d of ripening	Messens <i>et al.</i> , 2000
Queso Fresco	400	20	20	Cheese was less crumbly than control	Sandra <i>et al.</i> , 2004
La Serena	300–400	10	10	High-pressure treatments at 300 or 400 MPa on day 2 or day 50 of ripening significantly reduced the counts of undesirable microorganisms and, thus, improved the microbiological quality and safety of La Serena cheese immediately after treatment and at the end of the ripening period.	Arqués <i>et al.</i> , 2006

(continued overleaf)

Table 3.3 (continued)

Cheese	Pressure (MPa)	Treatment time (min)	Temperature (°C)	Effect of high-pressure treatment on the cheese	References
La Serena	300–400	10	10	HP treatment at day 2 of ripening resulted in a decelerated formation of volatile compounds; however, if HP was applied at day 50 of ripening, no effect on the sensory characteristics was found.	Arqués <i>et al.</i> , 2007
Garrotxa	400	5	14	Decelerated lipolysis, resulting in an altered volatile profile	Saldo <i>et al.</i> , 2003
Garrotxa	400	5	–	Lower cheese lightness after 60 d of ripening	Saldo <i>et al.</i> , 2002
Goat	300	10	–	Cheese treated at day 1 of ripening showed increase levels of FFA, however, the sensory characteristics were not preferred by the panel, cheese HP-treated at day 15 of ripening were preferred by the sensory panel	Juan <i>et al.</i> , 2008
Goat	200–500	10	1	HP treatment at day 1 <300 MPa increased and >400 MPa decelerated lipolysis	Juan <i>et al.</i> , 2007a
Goat	500	5, 15, 30	10, 25	Increased whey expulsion after HP treatment for 30 min at 25°C, but no changes in cheese composition	Capellas <i>et al.</i> , 2001
Blue-veined cheese	400/600	10	20	HP able to partially arrest ripening	Voigt <i>et al.</i> , 2010

in the volatile compounds were not large enough to suggest acceleration of ripening (Butz *et al.*, 2000).

3.6 High-Pressure Processing and Yoghurt

During the traditional process for the manufacture of yoghurt, milk is treated at high temperatures to induce significant levels of whey protein denaturation and, ultimately, yield an acid gel with enhanced strength and resistance to syneresis, or contraction leading to expulsion of whey; the key principle in yoghurt manufacture is, in fact, ensuring the involvement of as many milk constituents as possible in gel assembly.

The fact that HP can, under certain conditions, both induce significant levels of whey protein denaturation and reduce the size (and increase the number) of casein micelles, thereby increasing the number of structural elements available for gel assembly, made it a possible application of HP in dairy processing that was studied quite early. Significant differences in structure between yoghurt made from heat- or HP-treated milk have been reported (Needs *et al.*, 2000; Harte *et al.*, 2002). Microstructural changes in gel assembly have been correlated with changes in texture and rheological properties (Desobry-Banon *et al.*, 1994; Needs *et al.*, 2000; Harte *et al.*, 2002, 2003). However, many such differences disappeared when the yoghurt was stirred following acidification (Knudsen *et al.*, 2006). Yoghurt made from HP-treated milk was less susceptible to undesirable syneresis on storage, presumably due to changes in gel structure and water-binding capacity of milk proteins (Johnston *et al.*, 1993; Capellas and Needs, 2003). In addition, consumer studies of preference for yoghurt made from HP-treated or heat-treated milk reported that the former type of yoghurt may be scored more favourably by consumers in terms of texture and creaminess, although the flavour of the heat-treated sample was preferred (Capellas *et al.*, 2002).

Potential future developments of the use of high-pressure processing (HPP) in yoghurt manufacture may involve combining HPP with treatments such as cross-linking of milk proteins by transglutaminase (Capellas *et al.*, 2002; Anema *et al.*, 2005b) or optimization of the combination of HPP with heat treatment and/or addition of other ingredients, such as stabilizers or milk powders. Udabage *et al.* (2010) reported the microstructure and rheological properties of stirred yoghurt from milk that was HP-treated at pressures from 100 to 400 MPa and temperatures from 25 to 90°C, and found that HPP at elevated temperatures would reduce the ultimate viscosity of yoghurt.

A further possible application of HPP in yoghurt manufacture is the treatment of the gel following fermentation, to inactivate starter cultures and yeasts and moulds and, thereby, extend the shelf life of the product by prevention of post-acidification. There has also been some commercial interest in selection of barotolerant strains of probiotic bacteria that would survive such treatment selectively (De Cruz *et al.*, 2010).

3.7 High-Pressure Processing and Functional Dairy Products

In recent years, there has been a major focus from industry and researchers on the development of products, particularly dairy products, that can positively impact on human health beyond provision of basic nutrition. Products in this category

include probiotic products and those containing proteins or other agents proven to improve health.

For processors, one specific challenge relating to these products is the fact that the biological activities that confer the properties of interest (e.g. the presence of a bacterium or a native protein) must be preserved during manufacture, while undesirable activities (e.g. pathogenic or spoilage bacteria, or enzymes whose activity would impair product quality) are inactivated. The inability of conventional processes such as heat treatment to be sufficiently discriminating as to retain only certain properties has led to the investigation of the potential of novel technologies such as HPP for preservation of such products (De Cruz *et al.*, 2010). In addition, the fact that functional dairy products are high value makes this a product category for which the high cost of HPP equipment may not be as significant a barrier as for other types of product.

The applications of HPP to functional dairy products have been reviewed by Kelly and Zeece (2009). Particular applications of interest include reducing the allergenicity of whey proteins by unfolding under pressure to facilitate peptic hydrolysis (Zeece *et al.*, 2008; Kelly and Zeece, 2009), and use of HP to preserve colostrum. Colostrum is particularly rich in biologically active proteins such as immunoglobulins, and treatment with HP under certain conditions has been shown to retain biological activity better than heat treatment could achieve while ensuring a reasonable shelf life as a commercial product (Carroll *et al.*, 2006; Li *et al.*, 2006; Trujillo *et al.*, 2007; Indyk *et al.*, 2008). Recent research on human milk indicated that with HP treatment at 400 MPa for five minutes, it was possible to retain all immunoglobulin A (IgA) in milk serum, which offers passive protection to infants for the gastrointestinal system, which is usually destroyed by pasteurization using heat treatment (Permanyer *et al.*, 2010).

The company Fonterra in New Zealand has patented processes for preservation of colostrum using HP treatment and extending the shelf life of probiotic yoghurt (Carroll *et al.*, 2004).

3.8 Ice Cream

Potential applications of HP processing in ice cream manufacture were studied by (Huppertz *et al.*, 2011). For this purpose, ice cream mixes were prepared using conventional techniques and subsequently subjected to treatment at 200–500 MPa for one second to 20 minutes. At 400 or 500 MPa, even treatment for a time as short as one second was shown to increase mix viscosity. The increase in mix viscosity could be attributed to the formation of a proteinaceous network in the mix, consisting primarily of micellar fragments. Fat globule size in ice cream mixes was, as expected, not affected by HP treatment. When ice cream was prepared from HP-treated mixes, a similar proteinaceous network was observed and such ice creams showed a strong increase in resistance to meltdown. Informal sensory assessment suggested that ice cream prepared from HP-treated mixes had strongly improved textural characteristics, such as mouthfeel and creaminess.

Mechanistic studies on the HP-induced formation of a proteinaceous network in ice cream mix suggested that the formation of the network occurs on decompression of the ice cream mix and is driven by the reduction in solubility of calcium phosphate on release of pressure. The association of denatured whey proteins with casein micelles was found to hinder network formation, whereas smaller fat globules contributed more strongly to network formation. These findings highlight applications for HP processing in the manufacture of reduced-fat and stabilizer-free ice creams with

improved mouthfeel. In addition, the improved functionality of protein can facilitate cost savings by allowing ice cream manufacturers to reduce protein content in their product (Huppertz *et al.*, 2011).

3.9 Conclusions and Perspectives for the Dairy Industry

There is no question that the effects of HP treatment on milk have provided a rich field of scientific investigation in recent years and much is now understood about the complex changes that take place in milk under pressure. Due to this scientific richness of the field, far more papers relating to HP processing of dairy products have appeared in recent years compared to any other product category. However, compared to product categories such as meat and shellfish, where HP has become a relatively well established technology in recent years (Table 3.1), there is no doubt that the dairy industry has been relatively slow to embrace HP processing. The barriers for commercialization of HP processing for dairy products have been discussed in detail by Patel *et al.* (2008). Principal obstacles include the high cost and low scale of HP equipment, which mean that the process is more suited to high value, low volume materials, that is more favouring functional ingredients than bulk commodities such as cheese, and applications where existing alternative (more economical) technological solutions do not offer the advantages that HP can deliver.

However, this may be changing slowly. For example, a cheese spread that is HP treated to increase its shelf life came on the market in Spain in recent years. Also, as mentioned above, another key potential application for HP processing is colostrum, for which the application of HP, instead of heat, keeps all its unique beneficial health benefits (Carroll *et al.*, 2006).

A key question concerns the extent to which HP processing will be in use in the dairy industry in 10 years time. It seems inevitable that niche applications that build on the extensive scientific underpinning that now exists and offer unique advantages (and not just equivalence to existing processes) will be exploited.

References

- Abe, S., Kawashima, A., Masuda T. *et al.* (1999) Evaluation of heat deterioration of hard milk fat as a function of pressurization time by chemiluminescence analysis. *Food Sci Technol Res*, **5**: 381–383.
- Anema, S.G. (2008) Effect of milk solids concentration on whey protein denaturation, particle size changes and solubilization of casein in high-pressure-treated skim milk. *Int Dairy J*, **18**: 228–235.
- Anema, S.G., Lowe, E.K., Stockman, G. (2005a) Particle size changes and casein solubilization in high-pressure-treated skim milk. *Food Hydrocolloids*, **19**: 257–267.
- Anema, G.G., Lauber, S., Lee, S.K. *et al.* (2005b) Rheological properties of acid gels prepared from pressure- and transglutaminase-treated skim milk. *Food Hydrocolloids*, **19**: 879–887.
- Arias, M., Lopez-Fandino, R., Olano, A. (2000) Influence of pH on the effects of high pressure on milk proteins. *Milchwissenschaft*, **55**: 191–194.

- Arqués, J.L., Garde, S., Gaya, P. *et al.* (2006) Short Communication: Inactivation of Microbial contaminants in raw milk La Serena cheese by high-pressure treatments. *J Dairy Sci*, **89**: 888–891.
- Arqués, J.L., Garde, S., Fernández, E. *et al.* (2007) Volatile compounds, odor, and aroma of La Serena Cheese high-pressure treated at two different stages of ripening. *J Dairy Sci*, **90**: 3627–3639.
- Balci, A.T., Wilbey, R.A. (1999) High-pressure processing of milk – the first 100 years in the development of a new technology. *Int J of Dairy Technol*, **52**: 149–155.
- Belloque, J., Lopez-Fandino, R., Smith, G.M. (2000) A ¹H-NMR study on the effect of high pressures on β -lactoglobulin. *J Agric Food Chem*, **48**: 3906–3912.
- Black, E.P., Kelly, A.L., Fitzgerald, G.F. (2005) The combined effect of high pressure and nisin on inactivation of microorganisms in milk. *Innov Food Sci Emerg Technol*, **6**: 286–292.
- Buchheim, W., Abou El-Nour, A.M. (1992) Induction of milkfat crystallization in the emulsified state by high hydrostatic pressure. *Fat Science Technology*, **94**: 369–373.
- Butz, P.A., Fernandez, A., Koller, W.-D. *et al.* (2000) Effects of High Pressure treatment on fermentation processes during ripening of Gouda cheese. *High Pressure Res*, **19**: 37–41.
- Buzrul, S., Alpas, H., Largeteau, A. *et al.* (2008) Compression heating of selected pressure transmitting fluids and liquid foods during high hydrostatic pressure treatment. *J Food Eng*, **85**: 466–472.
- Capellas, M., Needs, E. (2003) Physical properties of yoghurt prepared from pressure-treated concentrated or fortified milks. *Milchwissenschaft*, **58**: 46–48.
- Capellas, M., Mor-Mur, M., Sendra, E., Guamis, B. (2001) Effect of high-pressure processing on physico-chemical characteristics of fresh goats' milk cheese Mato. *Int Dairy J*, **11**: 165–173.
- Capellas, M., Noronha, R., Mor-Muh, M., Needs, E. (2002) Effect of high pressure on the consumer liking and preference of yoghurt. *High Pressure Res*, **22**: 701–704.
- Carroll, T., Ping, C., Harnett, M., Harnett, J. (2004) Pressure treating food to reduce spoilage. International Patent Wo 2004/032655.
- Carroll, T.J., Patel, H., Gonzalez-Martin, M.A. *et al.* (2006) High pressure processing of bioactive compositions. International Patent Wo 2006/096074.
- De Cruz, A.G., Foncesca Faria, J. de A., Isay Saad, S.M. *et al.* (2010) High pressure processing and pulsed electric fields; potential use in probiotic dairy foods processing. *Trends Food Sci Technol*, **21**: 483–493.
- Desobry-Banon, S., Richard, F., Hardy, J. (1994) Study of acid and rennet coagulation of high pressurized milk. *J Dairy Sci*, **77**: 3267–3274.
- Dumay, E., Lambert, C., Funtenberger, S., Cheftel, J.C. (1996) Effects of high pressure on the physico-chemical characteristics of dairy creams and model oil/water emulsions. *Lebensmitteln Wissenschaft und Technologie*, **29**: 606–625.
- Eberhard, P., Strahm, W., Eyer, H. (1999) High pressure treatment of whipped cream. *Agrarforschung*, **6**: 352–354.
- Frede, E., Buchheim, W. (2000) The influence of high pressure upon the phase transition behaviour of milk-fat and milk-fat fractions. *Milchwissenschaft*, **55**: 683–686.
- Garcia-Risco, M.R., Olano, A., Ramos, M., Lopez-Fandino, R. (2000) Micellar changes induced by high pressure Influence in the proteolytic activity and organoleptic properties of milk. *J Dairy Sci*, **83**: 2184–2189.
- Garcia-Risco, M.R., Recio, I., Molina, E., Lopez-Fandino, R. (2003) Plasmin activity in pressurized milk. *J Dairy Sci*, **86**: 728–734.

- Garde, S., Arques, J.L., Gaya, P. *et al.* (2007) Effect of high-pressure treatments on proteolysis and texture of ewes' raw milk La Serena cheese. *Int Dairy J*, **17**: 1424–1433.
- Gaucheron, F., Famelart, M.H., Mariette, F. *et al.* (1997) Combined effects of temperature and high-pressure treatments on physicochemical characteristics of skim milk. *Food Chem*, **59**: 439–447.
- Gebhart, R., Doster, W., Kulozik, U. (2005) Pressure-induced dissociation of casein micelles: size distribution and effects of temperature. *Braz J Med Biol Res*, **38**: 1209–1214.
- Gervilla, R., Ferragut, V., Guamis, B. (2001) High hydrostatic pressure effects on color and milk fat globule size in ewe's milk. *J Food Sci*, **66**: 880–885.
- Harte, F., Amonte, M., Luedecke, L. *et al.* (2002) Yield stress and microstructure of set yoghurt made from high hydrostatic pressure-treated full fat milk. *J Food Sci*, **67**: 2245–2250.
- Harte, F., Luedecke, L., Swanson, B., Barbosa-Canovas, G. V. (2003) Low-fat set yoghurt made from milk subjected to combinations of high hydrostatic pressure and thermal processing. *J Dairy Sci*, **86**: 1074–1082.
- Hendrickx, M., Ludikhuyze, L., Van den Broek, I., Weemaes, C. (1998) Effects of high pressure on enzymes related to food quality. *Trends Food Sci Technol*, **9**: 197–203.
- Hinrichs, J., Rademacher, B. (2004) Kinetics of combined thermal and pressure-induced whey protein denaturation in bovine skim milk. *Int Dairy J*, **14**: 315–323.
- Hinrichs, J., Rademacher, B., Kessler, H.G. (1996) Reaction kinetics of pressure-induced denaturation of whey proteins. *Milchwissenschaft*, **51**: 504–509.
- Hite, B.H. (1899) The effect of high pressure preservation of milk. *Bulletin of the West Virginia Agricultural Experimental Station*, **58**: 15–35.
- Hubbard, C.D., Caswell, D., Lüdemann, H.D., Arnold, M. (2002) Characterization of pressure-treated skimmed milk powder dispersions: application of NMR spectroscopy. *J Sci Food Agric*, **82**: 1107–1114.
- Huppertz, T., De Kruif, C.G. (2006) Disruption and reassociation of casein micelles under high pressure: influence of milk serum composition and casein micelle concentration. *J Agric Food Chem*, **54**: 5903–5909.
- Huppertz, T., De Kruif, C.G. (2007a) High pressure-induced solubilisation of micellar calcium phosphate from cross-linked casein micelles. *Colloids Surf A*, **295**: 264–268.
- Huppertz, T., De Kruif, C.G. (2007b) Disruption and reassociation of casein micelles during high pressure treatment: influence of whey proteins. *J Dairy Res*, **74**: 194–197.
- Huppertz, T., Smiddy, M.A. (2008) Behaviour of partially cross-linked casein micelles under high pressure. *Int J Dairy Technol*, **61**: 51–55.
- Huppertz, T., Fox, P.F., Kelly, A.L. (2003) High pressure-induced changes in the creaming properties of bovine milk. *Innov Food Sci Emerging Technol*, **4**: 349–359.
- Huppertz, T., Fox, P.F., Kelly, A.L. (2004a) High pressure treatment of bovine milk: effects on casein micelles and whey proteins. *J Dairy Res*, **71**: 97–106.
- Huppertz, T., Fox, P.F., Kelly, A.L. (2004b) High pressure-induced denaturation of α -lactalbumin and β -lactoglobulin in bovine milk and whey: a possible mechanism. *J Dairy Res*, **71**: 489–495.
- Huppertz, T., Fox, P.F., Kelly, A.L. (2004c) Effect of cycled and repeated high pressure treatment on casein micelles and whey proteins in bovine milk. *Milchwissenschaft*, **59**, 123–126.
- Huppertz, T., Fox, P.F., Kelly, A.L. (2004d) Dissociation of caseins in high pressure-treated bovine milk. *Int Dairy J*, **14**: 675–680.

- Huppertz, T., Fox, P.F., Kelly, A.L. (2004e) Properties of casein micelles in high pressure-treated bovine milk. *Food Chem*, **87**: 103–110.
- Huppertz, T., Fox, P.F., Kelly, A.L. (2004f) Plasmin activity and proteolysis in high pressure-treated bovine milk. *Lait*, **84**: 297–304.
- Huppertz, T., Fox, P.F., De Kruif, K.G., Kelly, A.L. (2006a) High pressure-induced changes in bovine milk proteins: a review. *Biochimica et Biophysica Acta – Proteins and Proteomics*, **1764**: 593–598.
- Huppertz, T., Kelly, A.L., De Kruif, C.G. (2006b) Disruption and reassociation of casein micelles under high pressure. *J Dairy Res*, **73**: 294–298.
- Huppertz, T., Smiddy, M.A., Kelly, A.L., Goff, H.D. (2011) Effect of high pressure treatment of mix on ice cream manufacture. *Int Dairy J*, **21**: 718–727.
- Hvidt, A.A. (1975) Discussion of pressure-volume effects in aqueous protein solutions. *J Theor Biol*, **50**: 245–252.
- Ikeuchi, Y., Nakagawa, K., Endo, T. *et al.* (2001) Pressure-induced denaturation of monomer β -lactoglobulin is partially reversible: comparison of monomer form highly acidic pH with dimer form neutral pH. *J Agric Food Chem*, **49**: 4052–4059.
- Indyk, H.E., Williams, J.W., Patel, H.A. (2008) Analysis of denaturation of bovine IgG by heat and high pressure using an optical biosensor. *Int Dairy J*, **18**: 359–366.
- Johnston, D.E., Austin, B.A., Murphy, R.J. (1993) Properties of acid-set gels prepared from high pressure treated skim milk. *Michwissenschaft*, **48**: 206–209.
- Juan, B., Ferragut, V., Buffa, M. *et al.* (2007a) Effects of high-pressure treatment on free fatty acids release during ripening of ewes' milk cheese. *J Dairy Res*, **74**: 438–445.
- Juan, B., Trujillo, A.J., Guamis, V. *et al.* (2007b) Rheological, textural and sensory characteristics of high-pressure treated semi-hard ewes' milk cheese. *Int Dairy J*, **17**: 248–254.
- Juan, B., Ferragut, V., Guamis, B., Trujillo, A.J. (2008) The effect of high-pressure treatment at 300 MPa on ripening of ewes' milk cheese. *Int Dairy J*, **18**: 129–138.
- Kanno, C., Uchimura, T., Hagiwara, T. *et al.* (1998) Effect of hydrostatic pressure on the physicochemical properties of bovine milk fat globules and the milk fat globule membrane, in *High Pressure Food Science, BioScience and Chemistry* (ed. N. Isaacs). The Royal Society of Chemistry, Cambridge, pp. 182–192.
- Keenan, R.D., Young, D.J., Tier, C.M. *et al.* (2001) Mechanism of pressure-induced gelation of milk. *J Agric Food Chem*, **49**: 3394–3402.
- Kelly, A.L., Zeece, M. (2009) Applications of novel technologies in processing of functional foods. *Aust J Dairy Technol*, **64**: 12–15.
- Kelly, A.L., Huppertz, T., Sheehan, J.J. (2008) Review: Pre-treatment of cheese milk: principles and development. *Dairy Sci Technol*, **88**: 549–572.
- Kelly, A.L., Kothari, K.I., Voigt, D.D., Huppertz, T. (2009) Improving the technological and functional properties of milk by high-pressure processing, in *Dairy-Derived Ingredients: Food and Nutraceutical Uses* (ed. M Corredig). Woodhead Publishing Ltd, Oxford, UK, pp. 417–441.
- Knudsen, J.C., Skibsted, L.H. (2009) High pressure effects on the structure of casein micelles in milk as studied by cryo-transmission electron microscopy. *Food Chem*, **119**: 202–208.
- Knudsen, J.C., Karlsson, A.O., Ipsen, R., Skibsted, L.H. (2006) Rheology of stirred acidified skim milk gels with different particle interactions. *Colloids Surf A*, **274**: 56–61
- Kolakowski, P., Reps, A., Babuchowski, A. (1998) Characteristics of pressurized ripened cheeses. *Pol J Food Nutr Sci*, **7**: 473–482.

- Kromkamp, J., Moreira, R.M., Langeveld, L.P.M., Van Mil, P.J.J.M. (1996) Microorganisms in milk and yoghurt: selective inactivation by high hydrostatic pressure, in *Heat Treatments and Alternative Methods*. International Dairy Federation, Brussels, pp. 266–271.
- Kuwata, K., Li, H., Yamada, H. *et al.* (2001) High pressure NMR reveals a variety of fluctuating conformers in β -lactoglobulin. *J Molec Biol*, **305**: 1073–1083.
- Lado, B.H., Yousef, A.E. (2002) Alternative food-preservation technologies: efficacy and mechanisms. *Microbes Infect*, **4**: 433–440.
- Li, S.Q., Zhang, H.Q., Balasubramaniam, V.M. *et al.* (2006) Comparison of effects of high-pressure processing and heat treatment on immunoactivity of bovine milk immunoglobulin G in enriched soymilk under equivalent microbial inactivation levels. *J Agric Food Chem*, **54**: 739–746.
- Linton, M., Mackle, A.B., Upadhyay, V.K. *et al.* (2008) The fate of *Listeria monocytogenes* during the manufacture of Camembert-type cheese: A comparison between raw milk and milk treated with high hydrostatic pressure. *Innov Food Sci Emerg Technol*, **423–428**.
- López-Fandiño R. (2006) High pressure-induced changes in milk proteins and possible applications in dairy technology. *Int Dairy J*, **16**: 1119–1131.
- Lopez-Fandino, R., Olano, A. (1998) Effects of high pressures combined with moderate temperatures on the rennet coagulation properties of milk. *Int Dairy J*, **8**: 623–627.
- Lopez-Fandino, R., Carrascosa, A.V., Olano, A. (1996) The effects of high pressure on whey protein denaturation and cheese-making properties of raw milk. *J Dairy Sci*, **79**: 929–936.
- Lopez-Fandino, R., De la Fuente, M.A., Ramos, M., Olano, A. (1998) Distribution of minerals and proteins between the soluble and colloidal phases of pressurized milks from different species. *J Dairy Res*, **65**: 69–78.
- Marilley, L., Casey, M.G. (2004) Review article: Flavours of cheese products: metabolic pathways, analytical tools and identification of producing strains. *Int J Food Microbiol*, **90**: 139–159.
- Marshall, W.L., Frank, E.U. (1981) Ion product of water substance, 0–1000°C, 1–10000 bars New International Formulation and 1st background. *J Phys Chem Ref Data*, **10**: 295–304.
- Matser, A.M., Krebbers, B., Van den Berg, R.W., Bartels, P.V. (2004) Advantages of high pressure sterilisation on quality of food products. *Trends Food Sci Technol*, **15**: 79–85.
- McSweeney, P.L.H., Sousa, M.J. (2000) Biochemical pathways for the production of flavour compounds in cheeses during ripening: A review. *Lait*, **80**: 293–324.
- Messens, W., Estepar-Garcia, J., Dewettinck, Huyghebaert, K.A. (1999) Proteolysis of high-pressure-treated Gouda cheese. *Int Dairy J*, **9**: 775–782.
- Messens, W., Van de Walle, D., Arevalo, J. *et al.* (2000) Rheological properties of high-pressure-treated Gouda cheese. *Int Dairy J*, **10**: 359–367.
- Moller, R.E., Stapelfeldt, H., Skibsted, L.H. (1998) Thiol reactivity in pressure-unfolded β -lactoglobulin Antioxidative properties and thermal refolding. *J Agric Food Chem*, **46**: 425–430.
- Mozhaev, V.V., Heremans, K., Frank, J. *et al.* (1994) Exploiting the effects of high hydrostatic pressure in biotechnological applications. *Trends Biotechnol*, **12**: 493–501.
- Needs, E.C., Stenning, R.A., Gill, A.L. *et al.* (2000) High-pressure treatment of milk: effects on casein micelle structure and on enzymic coagulation. *J Dairy Res*, **67**: 31–42.
- O'Reilly, C.E., O'Connor, P.M., Murphy, P.M. *et al.* (2000) The effect of exposure to pressure of 50 MPa on Cheddar cheese ripening. *Innov Food Sci Emerg Technol*, **1**: 109–117.

- O'Reilly, C.E., Kelly, A.L., Murphy, P.M., Beresford, T.P. (2001) High pressure treatment: applications in cheese manufacture and ripening. *Trends Food Sci Technol*, **12**: 51–59.
- O'Reilly, C.E., O'Connor, P.M., Murphy, P.M. *et al.* (2002) Effects of high-pressure treatment on viability and autolysis of starter bacteria and proteolysis in Cheddar cheese. *Int Dairy J*, **12**: 915–922.
- O'Reilly, C.E., Kelly, A.L., Oliveira, J.C. *et al.* (2003) Effect of varying high-pressure treatment conditions on acceleration of ripening of cheddar cheese. *Innov Food Sci Emerg Technol*, **4**: 277–284.
- Orien, V., Knudsen, J.C., Colon, M., Skibsted, L.H. (2006) Dynamics of casein micelles in skim milk during and after high pressure treatment. *Food Chem*, **98**: 513–521.
- Pandey, P.K., Ramaswamy, H.S. (2004) Effect of high-pressure treatment of milk on lipase and γ -glutamyl transferase activity. *J Food BioChem*, **28**: 449–462.
- Patel, H., Carroll, T., Kelly, A.L. (2008) New dairy processing technologies, in *Dairy Processing Technology and Quality Assurance* (eds R.C. Chandan, A. Kilara and N.P. Shah) Elsevier, London, pp. 465–482.
- Payens, T.A.J., Heremans, K. (1969) *Effect of pressure on the temperature-dependent association of β -casein.* , **8**: 335–345.
- Permanyer, M., Castellote, C., Ramírez-Santana, C. *et al.* (2010) Maintenance of breast milk immunoglobulin A after high-pressure processing. *J Dairy Sci*, **93**: 877–883.
- Rademacher, B., Kessler, H.G. (1997) High pressure inactivation of microorganisms and enzymes in milk and milk products, in *High pressure Bio-Sci and Biotechnology* (ed. K. Heremans). Leuven University Press, Belgium, pp. 291–293.
- Rastogi, N.K., Raghavarao, K.S.M.S., Balasubramaniam, V.M. *et al.* (2007) Opportunities and Challenges in High Pressure Processing of Foods. *Criti Rev Food Sci Nutr*, **47**: 69–112.
- Regnault, S., Thiebaud, M., Dumay, E., Cheftel, J.C. (2004) Pressurisation of raw skim milk and of a dispersion of phosphocaseinate at 9°C or 20°C: effects on casein micelle size distribution. *Int Dairy J*, **14**: 55–68.
- Regnault, S., Dumay, E., Cheftel, J.C. (2006) Pressurisation of raw skim milk and of a dispersion of phosphocaseinate at 9°C or 20°C: effects on the distribution of minerals and proteins between colloidal and soluble phases. *J Dairy Res*, **73**: 91–100.
- Rendules, E., Omer, M.K., Alvseike, O. *et al.* (2011) Microbiological food safety assessment of high hydrostatic pressure processing: A review. *LWT – Food Sci Technol*, **44**: 1251–1260.
- Ross, A.I.V., Griffiths, M.W., Mittal, G.S., Deeth, H.C. (2003) Combining nonthermal technologies to control foodborne microorganisms. *Int J Food Microbiol*, **89**: 125–138.
- Rynne, N.M., Beresford, T.P., Guinee, T.P. *et al.* (2008) Effect of high-pressure treatment of 1day-old full-fat Cheddar cheese on subsequent quality and ripening. *Innov Food Sci Emerg Technol*, **9**: 429–440.
- Saldo, J., Sendra, E., Guamis, B. (2002) Colour changes during ripening of high pressure treated hard Caprine cheese. *High Pressure Res*, **22**: 659–663.
- Saldo, J., Fernandez, A., Sendra, E. *et al.* (2003) High pressure treatment decelerates the lipolysis in a caprine cheese. *Food Res Int*, **36**: 1061–1068.
- San Martín-González, M.F., Welti-Chanes, J., Barbosa-Cánovas, G.V. (2006) Cheese manufacture assisted by high pressure. *Food Rev Int*, **22**: 275–289.
- Sandra, S., Stanford, M.A., Meunier Goddik, L. (2004) The use of high-pressure processing in the production of Queso Fresco cheese. *Food Engin Phys Prop, J Food Sci*, **69**: 153–158.

- Schrader, K., Buchheim, W. (1998) High pressure effects on the colloidal calcium phosphate and the structural integrity of micellar casein in milk II Kinetics of the casein micelle disintegration and protein interactions in milk. *Kieler Milchwirtschaftliche Forschungsberichte*, **50**: 79–88.
- Scollard, P.G., Beresford, T.P., Murphy, P.M., Kelly, A.L. (2000a) Barostability of milk plasmin activity. *Lait*, **80**: 609–619.
- Scollard, P.G., Beresford, T.P., Needs, E.C. *et al.* (2000b) Plasmin activity, β -lactoglobulin denaturation and proteolysis in high pressure treated milk. *Int Dairy J*, **10**: 835–841.
- Sendra, E., Saldo, J., Capellas, M., Guamis, B. (2000) Decrease of free amino acids in high-pressure treated cheese. *High Pressure Res*, **19**: 33–36.
- Sheehan, J.J., Huppertz, T., Hayes, M.G. *et al.* (2005) High pressure treatment of reduced-fat Mozzarella cheese: Effects on functional and rheological properties. *Innov Food Sci Emerg Technol*, **6**: 73–81.
- Singh, T.K., Drake, M.A., Cadwallader, K.R. (2003) Flavor of Cheddar cheese: A chemical and sensory perspective. *Compr Rev Food Sci Food Saf*, **2**: 139–162.
- Smelt, J.P.P.M. (1998) Recent advances in the microbiology of high pressure processing. *Trends Food Sci Technol*, **9**: 152–158.
- Smith, K., Mendonca, A., Jung, S. (2009) Impact of high-pressure processing on microbial shelf-life and protein stability of refrigerated soymilk. *Food Microbiol*, **26**: 794–800.
- Stapelfeldt, H., Olsen, C.E., Skibsted, L.H. (1999) Spectrofluorometric characterization of β -lactoglobulin B covalently labeled with 2-4'-maleimidylanilino naphthalene-6-sulfonate. *J Agric Food Chem*, **47**: 3986–3990.
- Stipp, V.M., Delgado, A., Becker, T.M. (2005) Ionization equilibria at high pressure. *Eur Food Res Technol*, **221**: 151–156.
- Tanaka, N., Tsurui, Y., Kobayashi, I., Kunugi, S. (1996) Modification of the single unpaired sulphhydryl group of β -lactoglobulin under high pressure and the role of intermolecular S-S exchange in the pressure denaturation. *Int J Biol Macromol*, **19**: 63–68.
- Torres, J.A., Velazquez, G. (2005) Commercial opportunities and reserach challenges in the high pressure processing of food. *J Food Eng*, **67**: 95–112.
- Trujillo, A.J., Capellas, M., Buffa, M. *et al.* (2000) Application of high pressure treatment for cheese production. *Food Res Int*, **33**: 311–316.
- Trujillo, A.J., Capellas, M., Saldo, J. *et al.* (2002) Applications of high-hydrostatic pressure on milk and dairy products: a review. *Innovative Food Sci, Emerging Technologies*, **3**: 295–307.
- Trujillo, A.J., Castro, N., Quevedo, J.M. *et al.* (2007) Effect of heat and high-pressure treatments on microbiological quality and immunoglobulin G stability of caprine colostrum. *J Dairy Sci*, **90**: 833–839.
- Udabage, P., Augustin, M.A., Versteeg, C. *et al.* (2010) Properties of low-fat stirred yoghurts made from high-pressure-processed skim milk. *Innov Food Sci Emerg Technol*, **11**: 32–38.
- Velez-Ruiz, J.F., Swanson, B.G., Barbosa-Canovas. (1998) Flow and viscoelastic properties of concentrated milk treated with high hydrostatic pressure. *Lebensmittel Wissenschaft und Technologie*, **31**: 182–195.
- Voigt, D.D., Chevalier, F., Qian, M.C., Kelly, A.L. (2010) Effect of high-pressure treatment on microbiology, proteolysis, lipolysis and levels of flavour compound in mayure blue-veined cheese. *Innov Food Sci Emerg Technol*, **11**: 68–77.
- Wick, C., Nienaber, U., Anggraeni, O. *et al.* (2004) Texture proteolysis and viable lactic acid bacteria in commercial Cheddar cheeses treated with high pressure. *J Dairy Res*, **71**: 107–115.

- Ye, A., Anema, S.G., Singh, H. (2004) High-pressure–induced interactions between milk fat globule membrane proteins and skim milk proteins in whole milk. *J Dairy Sci*, **87**: 4013–4022.
- Yokohama, H., Sawamura, N., Motobayashi, N. (1992) Method for accelerating cheese ripening. European Patent Application, EP 0 469857 A1.
- Zeece, M., Huppertz, T., Kelly, A.L. (2008) Effect of high pressure treatment on *in vitro* digestibility of β -lactoglobulin. *Innov Food Sci Emerg Technol*, **9**: 62–69.
- Zobrist, M.R., Huppertz, T., Uniacke, T. *et al.* (2005) High pressure-induced changes in rennet-coagulation properties of bovine milk. *Int Dairy J*, **15**: 655–662.

4

Applications of High-Pressure Homogenization and Microfluidization for Milk and Dairy Products

John Tobin^{1,2}, Sinead P. Heffernan¹, Daniel M. Mulvihill¹, Thom Huppertz³, and Alan L. Kelly¹

¹School of Food and Nutritional Sciences, University College Cork, *Ireland*

²Moorepark Food Research Centre, *Ireland*

³NIZO food research, *The Netherlands*

4.1 Introduction

Emulsions comprise two immiscible liquid phases, a dispersed phase, typically consisting of droplets of sizes in the range 0.1–100 μm , and a continuous phase, with an interfacial layer between the phases stabilized by an emulsifier or surfactant. Emulsifiers are surface-active molecules that adsorb at the surface of oil droplets, reducing the interfacial tension, and thus providing stability to the dispersed droplets. If water forms the continuous phase, for example in milk, oil-in-water (o/w) emulsions are formed, whereas, in a water-in-oil (w/o) emulsion, for example butter, oil forms the continuous phase. Homogenization is the main technology used to produce emulsions, through mixing oil and aqueous phases, in the presence of a suitable emulsifier, or through the reduction in droplet size of an existing (pre-) emulsion.

Raw milk contains 3–5% fat, with fat globules ranging from 0.2 to 15 μm in diameter and a mean diameter of about 4 μm , dispersed in a continuous skimmed milk phase. The milk fat globules are surrounded by the milk fat globule membrane

(MFGM), which consists of phospholipids, proteins and neutral lipids, that protects the fat globules against flocculation and coalescence. In addition to the MFGM, milk proteins also have excellent emulsification properties (Mulvihill and Ennis, 2003). Homogenization at pressures typically in the range 10–30 MPa has been used for more than 100 years in the dairy industry to reduce milk fat globule size and, hence, prevent creaming on storage (Banks, 1993; Walstra, 1999) and is used today in the production of many dairy products such as milk, yoghurt, ice cream and cream liqueurs. Homogenization facilitates the production of dairy products with improved texture, taste, flavour and shelf life (Banks, 1993; McClements 1999; Paquin, 1999).

While traditional forms of homogenization have been applied in the dairy industry for over 100 years, this chapter reviews some recent developments in technologies for homogenization of dairy products, specifically those generally referred to as high-pressure homogenization and microfluidization (which operate at pressures from 100 to 300 MPa), and discusses their likely applications and implications for dairy products. Other novel emulsification technologies, such as membrane emulsification and ultrasonic emulsification, which have been studied mainly at laboratory scale, are not considered in this chapter.

4.2 Emulsion Stability and Instability

Emulsions may destabilize *via* a number of different mechanisms, including creaming, sedimentation and flocculation. Creaming occurs if the dispersed droplets have a lower density than that of the continuous phase, whereas sedimentation occurs if the droplets have a higher density. Creaming and sedimentation are very sensitive to the size distribution of the droplets, which is one of the most important factors influencing the stability of emulsions. Reducing the mean diameter of the droplets, for example through homogenization, therefore enhances the stability of an emulsion to creaming or sedimentation (Chanamai and McClements, 2000a, 2000b).

Flocculation occurs when two or more droplets come together to form an aggregate, wherein the droplets retain their individual integrity; flocculation is reversible unless coalescence occurs, whereby two or more small droplets form a larger one. This increase in diameter leads to more rapid creaming and, eventually, leads to the formation of an oil layer, referred to as oiling-off (McClements, 1999; van Aken, 2003). Coalescence of droplets arises from rupture of the film separating the droplets. Emulsion destabilization mechanisms, including creaming, flocculation and coalescence, are shown in Figure 4.1.

4.2.1 Effects of Homogenization

In order to produce stable emulsions, a dispersed phase must be distributed as fine droplets in a continuous phase. This involves two steps: droplet disruption and stabilization of the newly formed droplet surfaces by emulsifiers (Figure 4.2) (Walstra, 1993; Karbstein and Schubert, 1995). Droplet break-up is determined by the interfacial forces, which hold the droplets together, and the disruptive forces generated, which pull the droplets apart. The interfacial forces are characterised by the Laplace pressure (ΔP_L), which acts across the oil–water interface, so that there is a larger pressure inside the droplet than outside it. To deform and disrupt a droplet during homogenization, it is necessary to apply an external force that is significantly larger than the interfacial

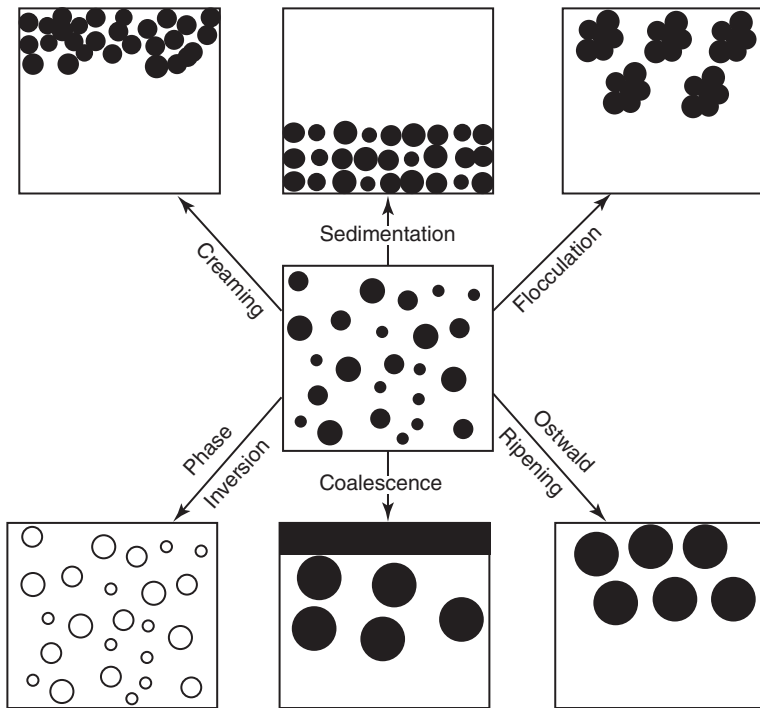

Figure 4.1 Schematic representation of the breakdown processes in emulsions (adapted from Tadros *et al.*, 2004).

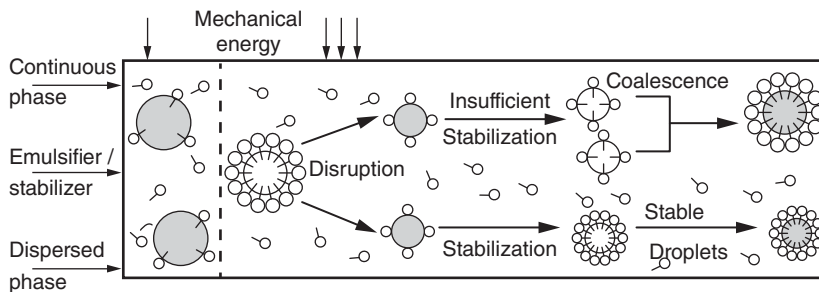

Figure 4.2 Mechanical emulsification process: Droplets in a pre-emulsion are disrupted in the dispersion zone by mechanical energy input followed by stabilization of the newly formed droplet surfaces by emulsifiers (adapted from Karbstein and Schubert, 1995).

forces. Disruptive forces acting on droplets during homogenization depend on the flow conditions experienced (laminar, turbulent or cavitation) and, therefore, on the type of homogenizer used. In most emulsification systems, multiple mechanisms of droplet disruption are important. For example, droplets may be deformed by forces in shear flow and, subsequently, disrupted in turbulent flow or by cavitation.

During conventional homogenization, there is usually a dynamic equilibrium between droplet break-up and coalescence that determines the final droplet size distribution. It has been reported that the impact forces that act on emulsion droplets as a result of the collisions during homogenization might be sufficient to cause disruption of the interfacial membrane at extremely high pressures. In turbulent flow, droplets are deformed and disrupted mostly by inertial forces that are generated by energy dissipating small eddies (Walstra, 1993). Inertial forces in turbulent flow are largely responsible for droplet disruption in many types of homogenizers (Stang *et al.*, 2001). As homogenization pressure increases, cavitation, shear and inertial forces, in addition to compression, acceleration, rapid pressure drop and impact forces, are significantly increased.

A decrease in static pressure results in the formation of cavities filled with gas or vapour, which collapse when the static pressure increases. The sudden collapse of bubbles caused by rapid increases in pressure induces shock waves, with accompanying extremely high local pressures and temperatures. Pressure impulses due to the collapse of bubbles filled with vapour or implosion of the bubbles are thought to be responsible for droplet disruption in cavitation. Such forces, in combination with extremely high temperature increases, may promote an increasing collision frequency between droplets and may lead to large droplet deformation and to forces stretching the adsorbed protein layers and thin films between colliding droplets (Robin *et al.*, 1993; Mohan and Narsimhan, 1997; Flourey *et al.*, 2000, 2004a; van Aken, 2003; Thiebaud *et al.*, 2003; McClements, 2004). Stretching leads to depletion of adsorbed materials, and re-coalescence may occur if protein-depleted regions on different droplets come into close proximity (McClements, 2004).

New emulsification systems are continuously being developed to produce emulsions with small mean droplet diameters and narrow size distributions more efficiently. The type of homogenizer used can make a large difference to the type of emulsion droplets which are formed (Dalglish *et al.*, 1996; Stang *et al.*, 2001; Tesch *et al.*, 2003; Schultz *et al.*, 2004; Perrier-Cornet *et al.*, 2005; Jafari *et al.*, 2007). The major process variables to be considered are the pressure, temperature, flow rate, dispersed phase concentration and emulsifier concentration; power input requirements should be low to reduce process costs. Some of the major developments in this regard are considered in this chapter.

4.2.2 Principles of High-Pressure Homogenization

In a high-pressure homogenizer, a high-pressure pump forces an emulsion through a narrow gap called the homogenization nozzle. During homogenization, the liquid upstream of the nozzle has a high potential energy, which, on entering the nozzle, is converted to kinetic energy. A combination of intense shear, cavitation and turbulent flow conditions results in droplet disruption. High-pressure homogenization (HPH) is accompanied by a pressure drop (cavitation), which can lead to further powerful implosive forces on the globules. High-pressure homogenizers can be subdivided into radial diffuser-type, counter-jet-disperser-type, and axial-flow-nozzle-type.

Schematic diagrams of the valves used in a number of types of high-pressure homogenizer are shown in Figure 4.3, while the flow geometries of conventional and high-pressure homogenizers are compared in Figure 4.4. The valve seat and piston for high-pressure homogenizers are often made of ceramics, which are able to withstand the high pressures and stresses encountered during the process. The pressurized

(a) Axial-flow-nozzle-type homogenizer

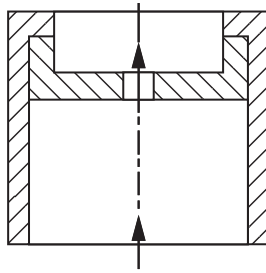

(b) Radial diffuser-type homogenizer

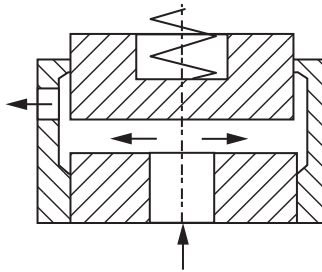

(c) Counter-jet-disperser-type homogenizer

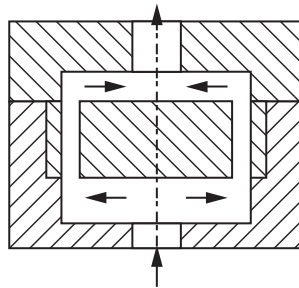

Figure 4.3 High-pressure homogenisers: (a) nozzle of an orifice nozzle homogenizer; (b) standard flat valve of a radial diffuser homogenizer; (c) interaction chamber of a counter-jet-disperser homogenizer (adapted from Stang *et al.*, 2001).

fluid flows axially in the homogenizing valve, past the piston and, subsequently, at extremely high velocity, through the gap formed between the piston and the valve seat. The pressure and velocity in the homogenizing valve are determined by the size of this adjustable valve gap. Subsequently, the fluid leaves the valve seat at atmospheric pressure.

On passing through a high-pressure homogenizer, milk or comparable products encounter a number of simultaneous and interlinked physical phenomena, including high velocity, shear, collision of particles, turbulence, and rapid increases and decreases in pressure and accompanying cavitation. In high-pressure homogenizers, fluid velocity increases very rapidly, from <0.5 m/s up to as high as 100 m/s on

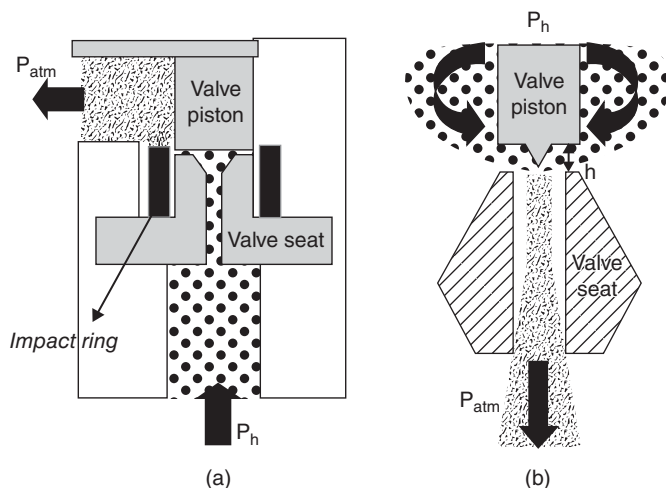

Figure 4.4 Flow geometries of: (a) conventional homogenizing valve (APV-Gaulin) and (b) Stansted high-pressure homogenizing valve (adapted from Flourey *et al.*, 2004b).

approach to the gap in the homogenizing valve (Flourey *et al.*, 2004a, 2004b). This strong acceleration results in elongational flow, which is probably the main mechanism of disruption of emulsion droplets. Velocity is further increased when the fluid accelerates into the gap between the valve and the valve seat and pressure suddenly drops and the fluid may, at pressures of 300 MPa, reach a velocity in the region of 200 m/s (Flourey *et al.*, 2004a, 2004b). These high velocities make the residence time in the homogenizing valve extremely short. During passage through the valve, high degrees of turbulence and cavitation can occur.

Large increases in temperature are also observed when milk is high-pressure-homogenized. Temperatures of about 65, 84 or 103°C have been reported downstream of the first homogenizing valve when milk at an initial temperature of 40°C was homogenized at 100, 200 or 300 MPa, respectively (Pereda *et al.*, 2007). The temperature of milk has generally been found to increase in near-linear fashion with homogenization pressure in HPH, at a rate of about 0.15–0.20°C/MPa (Hayes and Kelly, 2003a; Datta *et al.*, 2005; Hayes *et al.*, 2005; Picart *et al.*, 2006; Thiebaud *et al.*, 2003; Pereda *et al.*, 2007); temperature increases observed during HPH are largely independent of the temperature of the milk prior to homogenization. However, increases in temperature during HPH are dependent on the fat content of the milk, with the increase in temperature encountered on HPH of milk at 150 MPa increasing in linear fashion with fat content at a rate of about 0.5°C per % fat in milk (Hayes and Kelly, 2003a).

4.2.3 Microfluidization

A particular type of high-pressure homogenizer is of the counter-jet-disperser design. These are generally referred to as microfluidizers, based on the best known available system for such homogenization used in the food industry.

A microfluidizer can be described as a high-energy emulsification apparatus in which two or more opposed jets of coarse emulsion collide as they emerge from

at least two opposing bores or channels. In contrast to radial diffuser homogenizers, counter-jet-disperser homogenizers do not have any movable parts and the homogenization pressure is controlled by the flow rate.

The process of high-shear fluid processing using a microfluidizer was patented by Cook and Lagace (1985) and was first described for food applications by Paquin and Giasson (1989). Microfluidization is commonly used in the cosmetic and pharmaceutical industries to produce very fine emulsions (Robin *et al.*, 1992, 1993). Microfluidization has also been suggested as a suitable method for homogenization of milk (Paquin and Giasson, 1989; Robin *et al.*, 1992, 1993; McCrae, 1994; Dagleish *et al.*, 1996; Tosh and Dagleish, 1998; Hardham *et al.*, 2000).

During microfluidization, the product enters the system via an inlet reservoir and is delivered by a high-pressure intensifier pump into an interaction chamber at speeds of up to 400 m/s and pressures in the range 20–275 MPa. In the fixed-geometry interaction chamber, the liquid is divided into two or more microstreams (McCrae, 1994). These streams, travelling at high velocity, undergo a sudden pressure drop when they collide, frequently at a perpendicular angle, causing turbulence, cavitation, shear and ultimately droplet disruption (Hardham *et al.*, 2000). At the outlet of the interaction chamber, emulsified droplets are no longer subject to turbulent flow; therefore, interaction of small particles is less likely and a uniform distribution is maintained (Perrier-Cornet *et al.*, 2005). The product is subsequently rapidly cooled, if required, and collected in the output reservoir.

Compared to traditional homogenizers, microfluidizers are claimed to require less maintenance because there are no moving parts in the interaction chamber, and operate at higher pressures and generate emulsions with narrower particle size distributions (Banks, 1993). According to the manufacturer, the narrowest cross-section of the microfluidizer nozzle is 75 μm . A microfluidizer may be fitted with an auxiliary processing module designed to prevent clustering of droplets, similar to a second stage in a conventional valve homogenizer. Disadvantages can include ‘over processing’ at high processing pressures, whereby fat globule sizes increase due to interaction of small droplets and subsequent re-coalescence (Jafari *et al.*, 2007).

4.3 Effects of High-Pressure Homogenization and Microfluidization on Milk Constituents

4.3.1 Milk Fat Globules

The primary reason for homogenization in dairy processing is to reduce milk fat globule size, with the aim of prolonging physical shelf life and/or creating desirable textural attributes. It is thus not surprising that a considerable body of research on new homogenization technologies for application to milk systems has focused its effects on milk fat globules. In terms of HPH, when emulsion droplets pass through the valve of a high-pressure homogenizer, they encounter a number of processes simultaneously:

1. Deformation and disruption of droplets.
2. Adsorption of surface active material at the newly formed droplet interface.
3. Collision and possible re-coalescence of globules.

The balance between disruption of the original emulsion droplets and re-coalescence of newly formed droplets determines the final emulsion droplet size distribution in the

homogenized product. In general, decreases in milk fat globule size attained by HPH are greater than those attained by conventional homogenization (Hayes and Kelly, 2003a; Hayes *et al.*, 2003, 2005; Serra *et al.*, 2007). Typical parameters for the size distribution of particles in milk homogenized at 100 MPa in a high-pressure homogenizer are a volume-surface weighted mean diameter ($D[3,2]$) of about 0.2 μm and a volume-weighted mean diameter ($D[4,3]$) of about 0.5 μm . These values are typically about 1.0 μm and 4.5 μm , respectively, in unhomogenized milk and about 0.5 μm and 1.0 μm , respectively, in conventionally homogenized milk.

The two main determinants of fat globule size in high-pressure-homogenized milk are the pressure and temperature at which the homogenization is carried out. Minimum globule sizes are found at homogenization pressures of about 200–250 MPa (Hayes and Kelly, 2003a; Thiebaud *et al.*, 2003; Hayes *et al.*, 2005; Picart *et al.*, 2006; Serra *et al.*, 2007). At higher homogenization pressures, that is >250 MPa, milk fat globule size may actually increase again (Thiebaud *et al.*, 2003; Pereda *et al.*, 2007; Serra *et al.*, 2007); this is probably because the newly created fat globule surface is too large to be rapidly covered by surface active material, and clustering of the fat globules occurs. Kielczewska *et al.* (2000) reported that, while HPH decreased the mean diameter of milk fat globules, homogenization at pressures beyond 80 MPa increased the susceptibility of fat globules to coalescence.

In addition, it has been shown that warming milk to >30°C prior to HPH is essential for achieving the narrowest and smallest particle size distributions (Hayes and Kelly, 2003a; Thiebaud *et al.*, 2003; Datta *et al.*, 2005). This can be attributed to the fact that crystalline fat should be absent in the homogenization valve and, for this purpose, a minimum temperature of 45°C is commonly required. The rapid increase in temperature during HPH can certainly contribute to melting of fat but appears insufficient to allow cold homogenization of milk.

The effect of microfluidization on the properties of fat globules in liquid milk and dairy emulsions has been widely reported also. Even at relatively low pressures, microfluidization has been found to be more efficient in disrupting milk fat globules than conventional homogenization (McRae, 1994; Dalgleish *et al.*, 1996). Mean fat globule diameter in microfluidized milk decreased significantly with increasing pressure (Dalgleish *et al.*, 1996); however, McRae (1994) suggested that fat globule size is less sensitive to changes in operating pressure for microfluidization than for conventional homogenization. In terms of droplet disruption, an optimal microfluidization pressure of 50 MPa has been reported (Robin *et al.*, 1992). Microfluidization of milk yields very small emulsion droplets that are not present in conventionally homogenized milk (Pouliot *et al.*, 1991; Dalgleish *et al.*, 1996) and produces milk with lower levels of fat clustering (McCrae, 1994).

Microfluidization of milk results in a considerable rearrangement of the oil–water interface (McCrae, 1994; Dalgleish *et al.*, 1996; Dalgleish, 1997). In conventionally homogenized milks, casein micelles are adsorbed to and spread at the fat globule surface, while nonadsorbed casein micelles remain intact (Dalgleish *et al.*, 1996; Dalgleish, 1997). The fat globules in microfluidized milk are described as having thin well-defined membranes of approximately 10 nm thickness, devoid of large micellar fragments associated with conventional homogenization. Some of the larger fat globules produced by microfluidization were partially coated by smaller ones via protein bridges, and some of the smallest class of globules actually appeared to be embedded within casein micelles (Dalgleish *et al.*, 1996). Whey protein does not seem to be part

of the adsorbed layer in microfluidized milk, although it is present in conventionally homogenized milks (Dalglish *et al.*, 1996).

There is apparently an effective limit to the pressure that should be applied to milk during microfluidization, beyond which either no effect or a deleterious effect on particle size distribution is observed (Olson *et al.*, 2004). These authors found that, following microfluidization at pressures >100 MPa, the particle size of skimmed and 2% fat milk was not significantly further reduced, while for whole milk or 41% fat cream the particle size increased significantly at pressures greater than 100 MPa; these increases in particle size were attributed to fat clustering and, possibly, coalescence.

Robin *et al.* (1992) investigated the influence of microfluidization temperature and pressure on the size distribution of model dairy emulsions. The principal factors affecting fat globule size were, in order of importance, fat content, monoglyceride content, emulsification pressure, protein content and emulsification temperature. Robin *et al.* (1996) further reported on the influence of microfluidization and compositional variables on the surface protein load of model dairy emulsions. Schokker and Dalglish (1998) compared the effects of microfluidization and conventional homogenization on the calcium-induced flocculation of emulsions and found that lower levels of calcium were required to induce flocculation in microfluidized emulsions. Perrier-Cornet *et al.* (2005) reported that high-pressure-jet homogenization produced smaller particle sizes than microfluidization but that the latter yielded a more uniform size distribution.

Kanafusa *et al.* (2007) reported that microfluidization produced stable sodium caseinate-stabilized emulsions with narrow size distributions, but there was a maximum homogenization efficiency at a fixed protein content. Thompson and Singh (2006) prepared liposomes from milk fat globule material membrane using a microfluidizer and found that liposome size was related to phospholipid concentration (1, 5 or 10%) and number of passes through the microfluidizer; however, multiple passes did not significantly affect the polydispersity of the liposomes. Henry *et al.* (2010) demonstrated that kinetically stable submicron emulsions could be produced by microfluidization (200–350 nm) in systems containing phospholipids or whey proteins as emulsifiers.

4.3.2 Milk Proteins

While fat globules have, for obvious reasons, probably been most intensively studied in terms of effects thereon of new homogenization technologies, the effects of such processes on milk proteins have also been studied relatively widely.

Casein micelles are reported to be partially disrupted by HPH at ~200 MPa (Hayes and Kelly, 2003a; Sandra and Dalglish, 2005; Roach and Harte, 2008; Lodaite *et al.*, 2009). However, casein micelle size is far less dramatically altered by HPH than fat globule size; even the application of up to six homogenization steps at 186 MPa reduced particle size in skimmed milk only by about 10–15% (Sandra and Dalglish, 2005). Considering the time scale and pressures involved in HPH, it is likely that reductions in micelle size are the result of physical disruption of casein micelles or aggregates thereof, because the conditions would not allow significant solubilization of micellar calcium phosphate, which governs micellar disruption at high hydrostatic pressures. HPH of milk at pressures >250 MPa can cause increases in casein micelle size. In the presence of calcium, considerable aggregation of casein micelles can occur during HPH at >200 MPa (Roach and Harte, 2008).

HPH can result in denaturation of whey proteins, the extent of which increases with increasing homogenization pressure and is enhanced by the application of a second homogenization stage. HPH of skimmed milk at an inlet temperature of 30°C, a primary stage pressure of 300 MPa and a secondary stage pressure of 30 MPa resulted in about 45% denaturation of β -lactoglobulin and about 30% denaturation of α -lactalbumin (Serra *et al.*, 2008a; Pereda *et al.*, 2009). Whey protein denaturation during HPH is most likely largely due to thermal effects encountered during the process. The extent of HPH-induced whey protein denaturation in whole milk appears to be similar to that observed for skimmed milk (Datta *et al.*, 2005; Hayes *et al.*, 2005).

Microfluidization of milk proteins has been evaluated as a tool for production of microparticulated milk proteins that may function as fat replacers; conditions of pressure, temperature and number of passes were optimized to produce protein aggregates of a defined size and shape (Paquin *et al.*, 1993). In a similar study, Iordache and Jelen (2003) microfluidized heat-denatured whey proteins to improve their functionality and found that denatured whey proteins could be partially or even fully re-solubilized by high pressure microfluidization, allowing their incorporation in heated beverage systems without the formation of sediment during storage. Dissanayake and Vasiljevic (2009) found that a combination of heat treatment and microfluidization produced micro-aggregates of whey protein with enhanced heat stability and improved foaming properties, while emulsions formed using such proteins had a higher content of adsorbed protein and increased emulsifying activity index compared to nondenatured microfluidized proteins.

4.3.3 Milk Enzymes

The effect of homogenization of milk on lipases is particularly important, as homogenization facilitates access for lipases to the triglyceride core through changes in the fat globule membrane, thus facilitating lipolysis, which can reduce pH and result in a rancid flavour. HPH of milk at 100 or 200 MPa at an inlet temperature <40°C does not completely inactivate lipoprotein lipase in milk (Datta *et al.*, 2005; Pereda *et al.*, 2008a); in fact, treatment at this pressure at an inlet temperature of 10–30°C appears to greatly promote the lipolysis process in milk, probably as a result of incomplete inactivation of lipase combined with greatly facilitated access of the enzyme to the milk fat globules (Datta *et al.*, 2005). Homogenization of milk at 200 MPa at a milk inlet temperature >40°C does appear to result in complete inactivation of lipase in milk (Datta *et al.*, 2005; Pereda *et al.*, 2008a).

Hayes and Kelly (2003b) showed that HPH does not reduce activity of the indigenous milk proteinase plasmin in skimmed milk. However, in milk containing fat, plasmin activity decreased following HPH, with inactivation increasing with increasing pressure (Hayes and Kelly, 2003b; Hayes *et al.*, 2005), inlet temperature (Datta *et al.*, 2005) and the fat content of the milk (Hayes and Kelly, 2003b). Such reductions in plasmin activity were invariably attributed to inactivation of the enzyme. However, Lucci *et al.* (2008) showed that a large proportion of the reduction in plasmin activity observed is due to association of casein micelles, where plasmin is naturally found in milk, with milk fat globules during homogenization and their subsequent removal from the reaction mixture during sample preparation prior to analysis. These findings agree with observations that proteolysis in high-pressure-homogenized milk does

not differ significantly from that in untreated milk (Hayes and Kelly, 2003b). Only at conditions of high homogenization pressure (200 MPa) and high inlet temperature (50°C) did significant (<20%) inactivation of plasmin occur (Iucci *et al.*, 2008).

When milk is homogenized at an inlet temperature of 4°C, alkaline phosphatase is not inactivated at pressures <250 MPa, but homogenization at 200 MPa at inlet temperatures >20°C induced considerable inactivation of alkaline phosphatase (Hayes and Kelly, 2003b; Hayes *et al.*, 2005; Datta *et al.*, 2005; Picart *et al.*, 2006). Inactivation of lactoperoxidase in milk occurs on HPH of milk at 200 MPa at milk inlet temperatures >10°C (Datta *et al.*, 2005).

There have been no reports to date of inactivation of milk enzymes by microfluidization.

4.3.4 Microorganisms

Bacterial cells are strongly affected by the shear, cavitation, temperature and pressure occurring during HPH, and inactivation of a wide range of bacterial species can thus be achieved by this process. HPH-induced inactivation of bacteria increases with increasing pressure, temperature and fat content of the medium (Diels *et al.*, 2004, 2005; Vannini *et al.*, 2004; Hayes *et al.*, 2005; Pereda *et al.*, 2006, 2007; Picart *et al.*, 2006; Iucci *et al.*, 2007; Lanciotti *et al.*, 2007; Smiddy *et al.*, 2007; Capra *et al.*, 2009; Donsi *et al.*, 2009; Roig-Sagues *et al.*, 2009). Inactivation of bacteria by HPH appears to be related to the actual physical destruction of bacterial cells (Huppertz, 2011), and Gram-positive bacteria are more resistant to HPH-induced inactivation than Gram-negative bacteria (Donsi *et al.*, 2009). Diels *et al.* (2004, 2005) showed that the viscosity of the medium, rather than its composition, is the crucial factor affecting the degree of bacterial inactivation by HPH; in low viscosity media, bacterial cells are readily disrupted as a result of deformation under the forces encountered but, if viscosity is high, deformation, and hence disruption and inactivation, of bacterial cells is much more limited (Diels *et al.*, 2005).

There is little available information on inactivation of microorganisms in dairy systems by microfluidization. However, destruction of *Bacillus licheniformis* spores by microfluidization (50–200 MPa) of ice cream mixes has been evaluated (Feijoo *et al.*, 1997); spore destruction was correlated with increased processing pressure and a concomitant increase in temperature during processing, causing a multiplier effect on spore destruction.

4.4 Applications of HPH and Microfluidization in the Manufacture of Dairy Products

4.4.1 Milk

Because HPH can inactivate bacteria in milk, it has been suggested that the process can act as a one-step alternative for the pasteurization and homogenization of milk. Several studies have shown that combinations of sufficiently high pressure and inlet temperature, for example >150 MPa and >40°C, resulted in degrees of microbial inactivation that are comparable to those achieved during HTST pasteurization processes

commonly applied for the production of milk for consumption (Hayes *et al.*, 2005; Pereda *et al.*, 2006, 2007; Picart *et al.*, 2006; Smiddy *et al.*, 2007). The refrigerated shelf life of such high-pressure-homogenized milk is comparable to that of traditionally pasteurized/homogenized milk (Pereda *et al.*, 2006, 2007; Smiddy *et al.*, 2007). In addition, the HPH-induced reductions in fat globule size are efficient in decreasing the extent of creaming in milk (Hayes *et al.*, 2005).

However, residual lipase activity in milk homogenized at 200 MPa can lead to significant lipolysis in milk, as observed by increased levels of free fatty acids and reductions in pH (Hayes *et al.*, 2005; Pereda *et al.*, 2008a). Milk homogenized at 300 MPa has been shown to be very susceptible to lipid oxidation (Pereda *et al.*, 2008a), possibly due to the fact that the extremely large fat globule surface area created at this pressure cannot be covered adequately by the amount of surface active material present in the milk. Thus, while, from a microbiological perspective, HPH could potentially form a one-step alternative for pasteurization and homogenization of milk, increased levels of lipid oxidation and lipolysis (Pereda *et al.*, 2008a), as well as aldehydes (Pereda *et al.*, 2008b) in high-pressure-homogenized milk are likely to create an undesirable flavour profile.

Microfluidization has been used to reduce the extent of fat separation during storage of UHT milk (Hardham *et al.*, 2000). Microfluidized samples were deemed to be stable for up to nine months without excessive separation, compared to 2–3 months for conventionally homogenized samples.

4.4.2 Yoghurt Manufacture

Homogenization is almost always used in the manufacture of yoghurt and many other acid-coagulated dairy products; it plays a key role in achieving desirable texture, stability and mouthfeel, through the reduction in fat globule size and the adsorption of milk proteins on the fat globule interface. This increases the exposed casein surface area through the creation of a large number of casein-covered fat globules, which can then participate in the acid-coagulated milk gel. Since HPH decreases particle size more than conventional homogenization and is, thus, likely to increase exposed casein surface area even further, a number of studies have examined the suitability of this technology in the production of yoghurt. A further advantage of the use of HPH is that, as mentioned before, it can denature whey proteins in milk, which further contributes to the improvement of yoghurt texture and structure.

It has been reported that HPH alone, even at 350 MPa, cannot induce increases in gel strength to the same extent as traditional heat treatment, for example at 90°C (Hernandez and Harte, 2008; Serra *et al.*, 2008a). However, Serra *et al.* (2007, 2009a) reported that the firmness of set yoghurt gels prepared from milk (3.2% protein, 3.5% fat) homogenized at 200–300 MPa at an inlet temperature of 30 or 40°C was comparable or greater than that of milk fortified with 3% skimmed milk powder, homogenized conventionally (15 MPa) and heat treated at 90°C for 90 seconds.

Contradictory results have been published on the effect of homogenization pressure on the properties of acidified skimmed milk gels. Hernandez and Harte (2008) reported little effect on the storage modulus of acid milk gels of increasing pressure, while Serra *et al.* (2008a) reported reduced gel firmness with increasing homogenization pressure. When HPH and heat treatment were combined, increases in storage modulus were observed with increasing homogenization pressure.

HPH of milk at 200 or 300 MPa yielded stirred yoghurt with improved textural properties and water-holding capacity compared to stirred yoghurt prepared from the same milk fortified with 3% skimmed milk and treated by conventional homogenization and heating (Serra *et al.*, 2009a). The improved textural properties of yoghurt made from high-pressure-homogenized milk are probably largely attributable to the considerably lower milk fat globule size, and hence considerably increased casein surface area, in high-pressure-homogenized milk. Since whey protein denaturation during HPH is not complete (Serra *et al.*, 2007, 2009a), the combination of HPH and high heat treatment is likely to improve gel firmness even further.

Reduced susceptibility to syneresis has also been observed for yoghurt produced from high-pressure-homogenized milk (Serra *et al.*, 2007, 2009a), whereas fermentation times were largely unaffected (Serra *et al.*, 2007). For both set and stirred yoghurts, improvements in rheological properties and water-holding capacity were found to persist during storage at refrigeration conditions for up to 28 days. Proteolysis in yoghurt during the same storage period was not found to be affected by HPH (Serra *et al.*, 2009b) but, in yoghurt prepared from milk homogenized at 200 MPa at an inlet temperature of 30°C, conditions were insufficient to inactivate lipase and lipolysis was observed during storage (Serra *et al.*, 2008b).

These results indicate interesting opportunities for HPH in the manufacture of yoghurt products, particularly since the added cost as a result of the process may be balanced by savings in the reduced amount of protein required to prepare a product of desirable properties.

Cobos *et al.* (1995) studied the acid gelation of recombined milk prepared by microfluidization and conventional valve homogenization, and found that homogenizer type, temperature and pressure had no effect on the rheological properties of acid milk gels prepared with glucono-delta-lactone; solids content, heat treatment and incubation temperature were the main factors controlling rheological properties. Ciron *et al.* (2010a) compared the stability and textural properties of stirred yoghurts produced from microfluidized and conventionally homogenized milk. For fat-free yoghurts, microfluidization at 150 MPa had a deleterious effect on product quality, leading to increased syneresis, while reducing firmness, cohesiveness and viscosity. However, the textural and water-retention properties of low-fat yoghurts subjected to the same treatment were not significantly different from those produced by conventional homogenization, even though a more effective emulsification of the milk had occurred. Ciron *et al.* (2010b) studied the sensory characteristics and texture of yoghurt made from microfluidized milk and concluded that microfluidization may have applications for production of high quality yoghurt with reduced fat content.

4.4.3 Cheese

Homogenization has traditionally been avoided as a pretreatment for milk to be used for cheese making, as the key role of casein micelles in formation of the rennet gel is impaired by interaction with fat globules. Negative effects of homogenization on cheese making include hindered rennet coagulation, poor syneresis and high cheese moisture content, often accompanied by a coarse and brittle structure (Kelly *et al.*, 2008). In recent years, a number of studies have evaluated the impact of HPH, as opposed to traditional homogenization at much lower pressures, on cheese manufacture.

Zamora *et al.* (2007) studied the rennet coagulation properties of milk treated by single- or two-stage HPH at 100–330 MPa and reported that yield of rennet curds could be increased with pressure, through increased moisture content, and that the use of a second stage in HPH was less beneficial for rennet coagulation properties than single-stage processing. Lodaite *et al.* (2009) also used model systems to evaluate the impact of HPH on the rennet coagulation of skimmed or standard milk; they concluded that HPH-induced modifications to casein micelles and fat globules resulted in a significantly altered gel formation process, even in skimmed milk containing little or no fat.

Lanciotti *et al.* (2008) reported that Caciotta cheese made from bovine milk HPH-treated at 100 MPa had altered microbial populations, increased lipolysis and proteolysis, with modified volatile and sensory properties, compared to cheese made from control milk. Similar results for Pecorino cheese made from ovine milk HPH-treated at 100 MPa were reported by Vannini *et al.* (2008). Vannini *et al.* (2008) also found a modified microbial population in Italian cheese made from ovine or bovine milk HPH-treated at 100 MPa, as well as significantly reduced contents of biogenic amines.

HPH may have particular applications in manufacture of soft cheese types, where impaired whey drainage may not be a significant problem. Escobar *et al.* (2011) reported promising effects of HPH at pressures up to 300 MPa on yield and textural properties of Queso Fresco.

The effect of microfluidization of whole milk at 7 MPa or of cream at 14 and 69 MPa, followed by standardization of the fat content by mixing with skimmed milk, on the whiteness of Cheddar cheese has been studied (Lemay *et al.*, 1994); microfluidization of cheese milk produced Cheddar with a higher yield and whiter colour. However, cheese produced from microfluidized cream had poor texture, due to higher moisture content; whole milk microfluidized at 7 MPa produced good quality cheese, with a high yield.

Tosh and Dalgleish (1998) reported decreased fat globule size, reduced rennet coagulation time and reduced curd firming rate, with poor curd microstructure, following microfluidization of cheese milk. These authors concluded that casein micelles, disrupted during microfluidization, had adsorbed to the fat–serum interface, leading to the formation of a complex gel rather than the filled gel typically associated with curd formation, and thus a weakened curd structure.

The effect of microfluidization of milk on the rheology and microstructure of low-fat and high-fat Mozzarella cheese has been investigated (Tunick *et al.*, 2000; van Hekken *et al.*, 2007). Milk was microfluidized at 34 (conventional pressure for a valve-type homogenizer), 103 or 172 MPa, at temperatures of 10–54°C. Microfluidization of milk modified the microstructure of the high-fat cheese due to the formation of finer lipid dispersions, and cheese made from low-fat milk subjected to high pressures and temperatures had very poor stretching properties (Tunick *et al.*, 2000). Cheese made from microfluidized milk also had poor melt characteristics and altered rheological properties compared to control cheeses made from unhomogenized milk (van Hekken *et al.*, 2007).

4.4.4 Ice Cream

HPH and microfluidization have also been studied for their uses in manufacture of ice cream, a product in which the size, structure and stability of the emulsion droplets are

crucial for achieving desirable stability, texture and organoleptic properties of the final product, thus highlighting the potential of the technology in ice cream manufacture.

When emulsifier content was not adjusted, it was observed that HPH of high-fat ice cream mixes caused considerable coalescence and flocculation in the mixes, as shown by high fat globule sizes and bimodal particle size distribution, particularly in mixes homogenized at 200 MPa (Hayes *et al.*, 2003). Subsequent studies have shown that, when emulsifier concentration is increased accordingly, HPH at 200 MPa can be used successfully to create extremely fine emulsion droplets in ice cream mixes (Hupertz, unpublished data). Increases in ice cream mix viscosity have also been observed following HPH (Hayes *et al.*, 2003; Innocente *et al.*, 2009). HPH has been found to improve textural characteristic of ice cream; ice cream prepared from mix containing 5% fat homogenized at 100 MPa was found to be equivalent to that prepared from mix containing 8% fat that was homogenized at conventional pressure (18 MPa), thus highlighting possibilities for HPH in the improvement of textural characteristics of reduced-fat ice cream (Hayes *et al.*, 2003; Innocente *et al.*, 2009),

Olson *et al.* (2003) found that microfluidization of mixes decreased the rate of meltdown compared to conventionally processed ice cream; however, no significant improvement in sensory scores was reported. In a similar study (Morgan *et al.*, 2000), full-fat ice cream mixes were microfluidized (12–150 MPa) and analysed for emulsion stability and instrumental/sensory measures of ice cream quality; the highest sensory scores for creaminess were obtained for samples processed at the highest pressure, providing there was sufficient emulsifier present.

4.4.5 Cream Liqueurs

Cream liqueurs are products that typically contain cream, sodium caseinate, sugar, alcohol (typically 12–17%, w/w), flavours, colours and low molecular weight surfactants such as glycerol monostearate (Banks and Muir, 1988; Lynch and Mulvihill, 1997). The combination of high alcohol and sugar content presents significant hurdles against microbial growth in such products, and thus physical instability during storage is the main problem facing cream liqueur manufacturers (Banks *et al.*, 1981a, 1981b; Muir and Banks, 1987; Banks and Muir, 1988). Homogenization is thus a critical step in the manufacture of cream liqueurs, as a finely dispersed emulsion is required to ensure the long-term stability of the product. The effectiveness of homogenization in reducing fat globule size depends on feed temperature and homogenization pressure; higher homogenization pressures and feed temperatures are claimed to result in more stable products (Paquin and Giasson, 1989).

There may be advantages in microfluidization for products such as liqueurs that require a long shelf life, often at elevated storage temperatures (Hardham *et al.*, 2000). Paquin and Giasson (1989) showed that microfluidization yields cream liqueurs with a higher stability than standard homogenization due to a reduced mean droplet diameter. Heffernan *et al.* (2009) compared the effectiveness of HPH and conventional radial-diffusion homogenization for stabilization of cream liqueurs. The impact of HPH process variables, such as pressure, inlet temperature and number of passes, were studied and optimal conditions for production of stable liqueurs identified. Heffernan *et al.* (2011) extended this work to compare the effectiveness of HPH, microfluidization and ultrasonic emulsification for stabilization of cream liqueurs, and found that microfluidization produced emulsions with the smallest droplet diameters, and hence greatest stability. The smaller emulsion droplet size produced

in the microfluidizer has been reported to be due to the smaller dispersing volume in the interaction chamber compared to that of the radial diffuser in a conventional homogenizer (Stang *et al.*, 2001).

4.5 Conclusions and Future Perspectives

It is clear that, although both HPH and microfluidization have possible applications for the dairy industry, the products produced would need to be of high value to justify the movement away from conventional and well-established techniques. Microfluidization of full-fat milk does produce very stable emulsions; however, due to the short shelf life of milk, conventional homogenization probably remains the appropriate treatment for pasteurized refrigerated products, while HPH may result in flavour defects in milk. The stability of full-fat UHT milk to separation during storage was improved by microfluidization, yet cost effectiveness may still be an issue. Undeniably, both technologies can yield excellent particle size reduction and a narrow size distribution; however, certain conditions of temperature and pressure can, based on the composition of the system, that is protein and fat content, have deleterious effects on the emulsion such as coalescence or fat clustering.

Microfluidization is not suitable for the production of cheese, due to deleterious effects on the subsequent structure, while the potential application of HPH for such products will depend on the cheese system involved, and the relative benefits to be gained. Further studies of applications of both processes in the manufacture of yoghurt and ice cream may build on some interesting preliminary studies of such products to establish the commercial value of their use in industry. Both technologies also have interesting applications in the production of cream liqueurs, although this is a relatively niche product category.

Technologically speaking and from a cost effectiveness point of view, microfluidization is probably a technology more suitable for use in the production of high end/high value products and, as such, has a more likely uptake by the pharmaceutical and cosmetic industry for the production of long shelf life products (where there may be stability issues) or products requiring very fine emulsions. It is, however, a useful tool from a research point of view, allowing for the rapid production of very fine emulsions on a pilot scale.

References

- Banks W. (1993) Dairy products technology. *Journal of the Society of Dairy Technology*, **46**: 83–86.
- Banks W. and Muir D.D (1988). Stability of alcohol-containing emulsions. In: *Advances in Food Emulsions and Foams* (eds E. Dickinson and G. Stainby). Elsevier Science Publishing Co, New York, pp. 257–283.
- Banks W., Muir D.D. and Wilson A.G. (1981a) The formation of cream based liqueurs. *The Milk Industry*, **83**: 16–18.
- Banks W., Muir D.D. and Wilson A.G. (1981b) Extension of the shelf-life of cream-based liqueurs at high ambient temperatures. *Journal of Food Technology*, **16**: 587–595.

- Capra M.L., Patrignani F., del Lujan Quiberoni A. *et al.* (2009) Effect of high pressure homogenization on lactic acid bacteria phages and probiotic bacteria phages. *International Dairy Journal*, **19**: 336–341.
- Chanamai R. and McClements D.J. (2000a) Dependence of creaming and rheology of monodisperse oil-in-water emulsions on droplet size and concentration. *Colloids and Surfaces A: Physicochemical and Engineering Aspects*, **172**: 79–86.
- Chanamai R. and McClements D.J. (2000b) Creaming stability of flocculated monodisperse oil-in-water emulsions. *Journal of Colloid and Interface Science*, **225**: 214–218.
- Ciron C.I.E., Gee V.L., Kelly A.L. and Auty M.A.E. (2010a) Comparison of the effects of high-pressure Microfluidization and conventional homogenization of milk on particle size, water retention and texture of non-fat and low-fat yoghurts. *International Dairy Journal*, **20**: 314–320.
- Ciron C.I.E., Gee V.L., Kelly A.L. and Auty M.A.E. (2010b) Effects of Microfluidization of heat-treated milk on rheology and sensory properties of reduced-fat yoghurt. *Food Hydrocolloids*, **25**: 1470–1476.
- Cobos A., Horne D.S. and Muir D.D. (1995) Rheological properties of acid milk gels. II. Effect of composition, process and acidification conditions of products from recombined milks using the Microfluidizer. *Milchwissenschaft*, **50**: 603–606.
- Cook E.J. and Lagace A.P. (1985) Apparatus for forming emulsions. US Patent, 4,533,254.
- Dalgleish D.G. (1997) Adsorption of proteins and the stability of emulsions. *Trends in Food Science and Technology*, **8**: 1–6.
- Dalgleish D.G., Tosh S.M. and West S.J. (1996) Beyond homogenization: The formation of very small emulsion droplets during the processing of milk by a Microfluidizer. *Netherlands Milk and Dairy Journal*, **50**: 135–148.
- Datta N., Hayes M.G., Deeth H.C. and Kelly A.L. (2005) Significance of frictional heating for effects of high pressure homogenization on milk. *Journal of Dairy Research*, **72**: 393–399.
- Diels A.M.J., Callewaert L., Wuyack E.Y. *et al.* (2004) Moderate temperature affects *Escherichia coli* inactivation by high-pressure homogenization only through fluid viscosity. *Biotechnology Progress*, **20**: 1512–1517.
- Diels A.M.J., Callewaert L., Wuyack E.Y. *et al.* (2005) Inactivation of *Escherichia coli* by high-pressure homogenization is influenced by fluid viscosity but not by water activity and product composition. *International Journal of Food Microbiology*, **101**: 281–291.
- Dissanayake M. and Vasiljevic T. (2009) Functional properties of whey proteins affected by heat treatment and hydrodynamic high-pressure shearing. *Journal of Dairy Science*, **94**: 1387–1397.
- Donsi F., Ferrari G., Lenza E. and Maresca P. (2009) Main factors regulating microbial inactivation by high-pressure homogenization: operating parameters and scale of operation. *Chemical Engineering Science*, **64**: 520–532.
- Escobar D., Clark S., Ganesan V. *et al.* (2011) High-pressure homogenization of raw and pasteurized milk modifies the yield, composition and texture of queso fresco cheese. *Journal of Dairy Science*, **94**: 1201–1210.
- Feijoo S.C., Hayes W.W., Watson C.E. and Martin J.H. (1997) Effects of microfluidizer technology on *Bacillus licheniformis* spores in ice cream mix. *Journal of Dairy Science*, **80**: 2184–2187.
- Floury J., Desrumaux A. and Lardières J. (2000) Effect of high-pressure homogenization on droplet size distributions and rheological properties of model-oil-in-water emulsions. *Innovative Food Science and Emerging Technologies*, **1**: 127–134.

- Floury J., Legrand J. and Desrumaux A. (2004a) Analysis of a new type of high-pressure homogeniser. Part B. Study of droplet break-up and re-coalescence phenomena. *Chemical Engineering Science*, **59**: 1285–1294.
- Floury J., Bellettre J., Legrand J. and Desrumaux A. (2004b) Analysis of a new type of high-pressure homogeniser. A study of the flow pattern. *Chemical Engineering Science*, **59**: 843–853.
- Hardham J.F., Imison B.W. and French H.M. (2000) Effect of homogenization and microfluidisation on the extent of fat separation during storage of UHT milk. *Australian Journal of Dairy Technology*, **55**: 16–22.
- Hayes M.G. and Kelly A.L. (2003a) High-pressure homogenization of raw bovine milk (a) effect on fat globule size and other properties. *Journal of Dairy Research*, **70**: 297–305.
- Hayes M.G. and Kelly A.L. (2003b) High-pressure homogenization of milk (b) effects on indigenous enzymatic activity. *Journal of Dairy Research*, **70**: 307–313.
- Hayes M.G., Lefrancois A.C., Waldron D.S. *et al.* (2003) Influence of high-pressure homogenization on some characteristics of ice cream. *Milk Science International*, **58**: 465–580.
- Hayes M.G., Fox P.F. and Kelly A.L. (2005) Potential applications of high pressure homogenization in processing of liquid milk. *Journal of Dairy Research*, **72**: 25–33.
- Heffernan S.P., Kelly A.L. and Mulvihill D.M. (2009) High-pressure-homogenised cream liqueurs: emulsification and stabilization efficiency. *Journal of Food Engineering*, **95**: 525–531.
- Heffernan S.P., Kelly A.L., Mulvihill D.M. *et al.* (2011) Efficiency of a range of homogenization technologies in the emulsification and stabilisation of cream liqueurs. *Innovative Food Science and Emerging Technologies*, **12**(4): 628–634.
- Henry J.V.L., Fryer P.J., Frith W.J. and Norton I.T. (2010) The influence of phospholipids and food proteins on the size and stability of sub-micron emulsions. *Food Hydrocolloids*, **24**: 66–71.
- Hernandez A. and Harte F.M. (2008) Manufacture of acid gels from skim milk using high-pressure homogenization. *Journal of Dairy Science*, **91**: 3761–3767.
- Huppertz T. (2011) Homogenization of milk: high pressure homogenizers. In: *Encyclopedia of Dairy Sciences*, 2nd edn (eds J.W. Fuquay, P.F. Fox and P.L.H. McSweeney). Academic Press, San Diego, CA, pp. 755–760.
- Innocente N., Biasutti M., Venir E. *et al.* (2009) Effect of high-pressure homogenization on droplet size distribution and rheological properties of ice cream mixes. *Journal of Dairy Science*, **92**: 1864–1875.
- Iordache M. and Jelen P. (2003) High pressure Microfluidization treatment of heat denatured whey proteins for improved functionality. *Innovative Food Science and Emerging Technologies*, **4**: 367–376.
- Iucci L., Patrignani F., Vallicelli M. *et al.* (2007) Effects of high pressure homogenization on the activity of lysozyme and lactoferrin against *Listeria monocytogenes*. *Food Control*, **18**: 558–565.
- Iucci L., Lanciotti R., Kelly A.L. and Huppertz T. (2008) Plasmin activity in high-pressure-homogenised milk. *Milchwissenschaft*, **63**: 68–70.
- Jafari S.M., He Y. and Bhandari B. (2007) Production of sub-micron emulsions by ultrasound and Microfluidization techniques. *Journal of Food Engineering*, **82**: 478–488.
- Kanafusa S., Chu B. and Nakajima M. (2007). Factors affecting droplet size of sodium caseinate-stabilized o/w emulsions containing B-carotene. *European Journal of Lipid Science and Technology*, **109**: 1038–1041.

- Karbstein H. and Schubert H. (1995) Developments in the continuous mechanical production of oil-in-water macro emulsions. *Chemical Engineering and Processing*, **34**: 205–211.
- Kelly A.L., Huppertz T. and Sheehan J. J. (2008) Pre-treatment of cheese milk: principles and developments. *Dairy Science and Technology*, **88**(4–5), 549–572.
- Kielczewska K., Haponiuk E. and Krzyzewska A. (2000) Effect of high-pressure homogenization on some physicochemical properties of milk. *Mededelingen- Faculteit Landbouwkundige en Toegepaste Biologische Wetenschappen Universiteit Gent*, **65**(3b): 603–606.
- Lanciotti R., Patrignani F., Iucci L. *et al.* (2007) Potential of high pressure homogenization in the control and enhancement of proteolytic and fermentative activities of some *Lactobacillus* species. *Food Chemistry*, **102**: 542–550.
- Lanciotti R., Vannini L., Patrignani F. *et al.* (2008) Effects of high pressure homogenization of milk on cheese yield and microbiology, lipolysis and proteolysis during Caciotta cheese. *Journal of Dairy Research*, **73**: 216–226.
- Lemay A., Paquin P. and Lacroix C. (1994) Influence of Microfluidization of milk on cheddar cheese composition, color, texture and yield. *Journal of Dairy Science*, **77**: 2870–2879.
- Lodaite K., Chevalier F., Armaforte E. and Kelly A.L. (2009) Effect of high-pressure homogenization on rheological properties of rennet-induced skim milk and standardised milk gels. *Journal of Dairy Science*, **76**: 294–300.
- Lynch A.G. and Mulvihill D.M. (1997) Effect of sodium caseinate on the stability of cream liqueurs. *International Journal of Dairy Technology*, **50**: 1–7.
- McClements D.J. (1999) *Food Emulsions: Principles, Practices and Techniques*. CRC Press, Boca Raton, FL.
- McClements D.J. (2004) Protein-stabilized emulsions. *Current Opinion in Colloid and Interface Science*, **9**: 305–313.
- McCrae C. (1994) Homogenization of milk emulsions: use of Microfluidizer. *Journal of the Society of Dairy Technology*, **47**: 28–31.
- Mohan S. and Narsimhan G. (1997) Coalescence of protein-stabilized emulsions in a high-pressure homogenizer. *Journal of Colloid and Interface Science*, **192**: 1–15.
- Morgan D., Hosken B. and Davis C. (2000) Microfluidised ice-cream emulsions. *Australian Journal of Dairy Technology*, **55**: 93–93.
- Muir D.D. and Banks W. (1987) Cream Liqueurs. *Hannah Research*, pp. 83–88.
- Mulvihill D.M. and Ennis M.P. (2003) Functional milk proteins: production and utilization. In: *Advanced Dairy Chemistry-1 Proteins*, (eds P.F. Fox and P.L.H. McSweeney). Kluwer Academic, New York, pp. 1175–1219.
- Olson D.W., White C.H. and Watson C.E. (2003) Properties of frozen dairy desserts processed by Microfluidization of their mixes. *Journal of Dairy Science*, **86**: 1157–1162.
- Olson D.W., White C.H. and Richter, R.L. (2004) Effect of pressure and fat content on particle sizes in microfluidized milk. *Journal of Dairy Science*, **87**: 3217–3223.
- Paquin P. (1999) Technological properties of high-pressure homogenizers: the effects of fat globules, milk proteins and polysaccharides. *International Dairy Journal*, **9**: 329–335.
- Paquin P. and Giasson J. (1989) Microfluidization as an homogenization process for cream liqueur. *Lait*, **69**: 491–498.
- Paquin P., Lebeuf Y., Richard J. P. and Kalab M. (1993) Microparticulation of milk proteins by high pressure homogenization to produce a fat substitute. *International Dairy Federation, Special Issue No. 9303*, 389–396.

- Pereda J., Ferragut V., Guamis B. and Trujillo A.J. (2006) Effect of ultra high-pressure homogenization on natural-occurring micro-organisms in bovine milk. *Milchwissenschaft*, **61**: 245–248.
- Pereda J., Ferragut V., Quevedo J.M. *et al.* (2007) Effects of ultra-high pressure homogenization on microbial and physicochemical shelf life of milk. *Journal of Dairy Science*, **90**: 1081–1093.
- Pereda J., Ferragut V., Quevedo J.M. *et al.* (2008a) Effects of ultra-high-pressure homogenization treatment on the lipolysis and lipid oxidation of milk during refrigerated storage. *Journal of Agricultural and Food Chemistry*, **56**: 7125–7130.
- Pereda J., Jaramillo D.P., Quevedo J.M. *et al.* (2008b) Characterization of volatile compounds in ultra-high-pressure homogenized milk. *International Dairy Journal*, **18**: 826–834.
- Pereda J., Ferragut V., Quevedo J.M. *et al.* (2009) Heat damage evaluation in ultra-high pressure homogenized milk. *Food Hydrocolloids*, **23**: 1974–1979.
- Perrier-Cornet J.M., Marie P. and Gervais P. (2005) Comparison of emulsification efficiency of protein-stabilized oil-in-water emulsions using jet, high pressure and colloid mill homogenization. *Journal of Food Engineering*, **66**: 211–217.
- Picart L., Thiebaut M., Rene M. *et al.* (2006) Effects of high pressure homogenization of raw bovine milk on alkaline phosphate and microbial inactivation. A comparison with continuous short-time thermal treatments. *Journal of Dairy Research*, **73**: 454–463.
- Pouliot Y., Paquin P., Robin O. and Giasson J. (1991) Étude comparative de l'effet de la microfluidisation et de l'homogénéisation sur la distribution de la taille des globules de gras du lait de vache. *International Dairy Journal*, **1**: 39–49.
- Roach A. and Harte F. (2008) Disruption and sedimentation of casein micelles and casein micelle isolated under high-pressure homogenization. *Innovative Food Science and Emerging Technologies*, **9**: 1–8.
- Robin O., Blanchot V., Vuilleumard J.C. and Paquin P. (1992) Microfluidization of dairy model emulsions. I. Preparation of emulsions and influence of processing and formulation on the size distribution of milk fat globules. *Lait*, **72**: 511–531.
- Robin O., Remillard N. and Paquin P. (1993) Influence of major process and formulation parameters on microfluidized fat globule size distribution and example of a practical consequence. *Colloids and Surfaces A: Physicochemical and Engineering Aspects*, **80**: 211–222.
- Robin O., Kalab M., Britten M. and Paquin P. (1996) Microfluidization of model dairy emulsions. 2. Influence of composition and process factors on the protein surface concentration. *Lait*, **76**: 551–570.
- Roig-Sagues A.X., Velazquez R.M., Montealegre-Agramont P. *et al.* (2009) Fat content increases the lethality of ultra-high-pressure homogenization on *Listeria monocytogenes* in milk. *Journal of Dairy Science*, **92**: 5396–5402.
- Sandra S. and Dalgleish D.G. (2005) Effects of ultra-high-pressure homogenization and heating on structural properties of casein micelles in reconstituted skim-milk powder. *International Dairy Journal*, **15**: 1095–1104.
- Schokker E.P. and Dalgleish D.G. (1998) The shear-induced destabilization of oil-in-water emulsions using caseinate as emulsifier. *Colloids and Surfaces A: Physicochemical and Engineering Aspects*, **145**: 61–69.
- Schultz S., Wagner G., Urban K. and Ulrich J. (2004) High-pressure homogenization as a process for emulsion formation. *Chemical Engineering Technology*, **27**: 361–368.

- Serra M., Trujillo A.J., Quevedo J.M. *et al.* (2007) Acid coagulation properties and suitability for yoghurt production of cow's milk treated by high-pressure homogenization. *International Dairy Journal*, **17**: 782–790.
- Serra M., Trujillo A.J., Jaramillo P.D. *et al.* (2008a) Ultra-high pressure homogenization-induced changes in skim milk: impact on acid coagulation properties. *Journal of Dairy Research*, **75**: 69–75.
- Serra M., Trujillo A.J., Pereda J. *et al.* (2008b) Quantification of lipolysis and lipid oxidation during cold storage of yoghurts produced from milk treated by ultra-high pressure homogenization. *Journal of Food Engineering*, **89**: 99–104.
- Serra M., Trujillo A.J., Guamis B. and Ferragut V. (2009a) Evaluation of physical properties during storage of set and stirred yoghurt made from ultra-high pressure homogenization-treated milk. *Journal of Dairy Research*, **23**: 82–91.
- Serra M., Trujillo A.J., Guamis B. and Ferragut V. (2009b) Proteolysis in yoghurt made from ultra-high-pressure homogenized milk during cold storage. *Journal of Dairy Science*, **92**: 71–78.
- Singh H. (2006) The milk fat globule membrane – A biophysical system for food applications. *Current Opinion in Colloid and Interface Science*, **11**: 154–163.
- Smiddy M.A., Martin J.E., Huppertz T. and Kelly A.L. (2007) Microbial shelf-life of high-pressure-homogenised milk. *International Dairy Journal*, **17**: 29–32.
- Stang M., Schuchmann H. and Schubert H. (2001) Emulsification in high-pressure homogenizers. *Engineering Life Science*, **1**: 151–157.
- Tadros T., Izquierdo P., Esquena J. and Solans C. (2004) Formation and stability of nano-emulsions. *Advances in Colloid and Interface Science*, **108–109**: 303–318.
- Tesch S., Freudig B. and Schubert H. (2003) Production of emulsions in high-pressure homogenizers – Part 1: Disruption and stabilization of droplets. *Chemical Engineering Technology*, **26**: 569–573.
- Thiebaud M., Dumay E., Picart L. *et al.* (2003) High-pressure homogenization of raw bovine milk. Effects on fat globule size distribution and microbial inactivation. *International Dairy Journal*, **13**: 427–439.
- Thompson A.K. and Singh H. (2006) Preparation of liposomes from milk fat globule membrane phospholipids using a microfluidizer. *Journal of Dairy Science*, **89**: 410–419.
- Tosh S. and Dalgleish D.G. (1998) The physical properties and renneting characteristics of the synthetic membrane on the fat globules of microfluidised milk. *Journal of Dairy Science*, **81**: 1840–1847.
- Tunick M.H., van Hekken D.L., Cooke P.H. *et al.* (2000) Effect of high pressure Microfluidization on microstructure of mozzarella cheese. *Lebensmittel-Wissenschaft und-Technologie – Food Science and Technology*, **33**: 538–544.
- van Aken G.A. (2003) Coalescence mechanisms in protein-stabilized emulsions. In: *Food Emulsions-8*, 4th edn (eds S. Friberg, K. Larsson and J. Sjoblom). Marcel Dekker/ CRC Press, New York, pp. 299–325.
- van Hekken D.L., Tunick M.H., Malin E.L. and Holsinger V.H. (2007) Rheological and melt characterization of low-fat and full fat mozzarella cheese made from microfluidised milk. *LWT – Food Science and Technology*, **40**: 89–98.
- Vannini L., Lanciott R., Baldi D. and Guerzoni M.E. (2004) Interactions between high pressure homogenization and antimicrobial activity of lysozyme and lactoperoxidase. *International Journal of Food Microbiology*, **94**: 123–135.

- Vannini L., Patrignani F., Iucci L. *et al.* (2008) Effect of a pre-treatment of milk with high pressure homogenization on yield as well as on microbiological, lipolytic and proteolytic patterns of “Pecorino” cheese. *International Journal of Food Microbiology*, **128**: 329–335.
- Walstra P. (1993) Principles of emulsion formation. *Chemical Engineering Science*, **48**: 333–349.
- Walstra P. (1999) Colloidal particles of milk. In: *Dairy Technology: Principles of Milk Properties and Processes* Eds T.J. Geurts, A. Noomen, A. Jelema, and M.A.J.S van Boekel). Marcel Dekker, New York, pp. 107–147.
- Zamora A., Ferregut V., Jaramillo P.D. *et al.* (2007) Effects of ultra-high-pressure homogenization on the cheese-making properties of milk. *Journal of Dairy Science*, **90**: 13–23

5

Pulsed Electric Fields (PEF) Processing of Milk and Dairy Products

Fernando Sampedro¹ and Dolores Rodrigo²

¹Center for Animal Health and Food Safety, College of Veterinary Medicine, University of Minnesota, USA

²Instituto de Agroquímica y Tecnología de Alimentos (IATA-CSIC), Spain

5.1 Introduction

5.1.1 Technology Principles

For many years, high intensity electric fields have been applied to induce electroporation, a phenomenon used to promote bacterial DNA interchange by perforating microbial membranes (Zhang *et al.*, 1995). Advances in the design of the treatment chamber led to the development of a new processing technology known as pulsed electric fields (PEF) (Vega-Mercado *et al.*, 1997). PEF technology involves the treatment of a biological material or food placed between two electrodes installed 0.1–1.0 cm apart in a treatment chamber separated by an insulator, with short pulses (1–10 μ s) that are generated by a high voltage (5–20 kV) pulse generator. A power source is used to charge a capacitor bank and a switch is used to discharge energy to the treatment chambers (Zhang *et al.*, 1995). The first type of chamber used for studies on microbial inactivation in liquid food was a static chamber designed for treating a small volume of sample inside a cylindrical vessel with two parallel electrodes (Grahl and Markl 1996; Martin *et al.*, 1997; Picart *et al.*, 2002). Static chambers have been used in research studies for the extraction of bioactive compounds, improvement of dehydration and rehydration and juice yield of plant based foods by applying electric voltage (Ade-Omowaye *et al.*, 2001; Guderjan *et al.*, 2005; Soliva-Fortuny *et al.*, 2009).

Advances in chamber design also led to the introduction of continuous systems for pasteurization of liquid foods with new configurations such as the cofield (applying

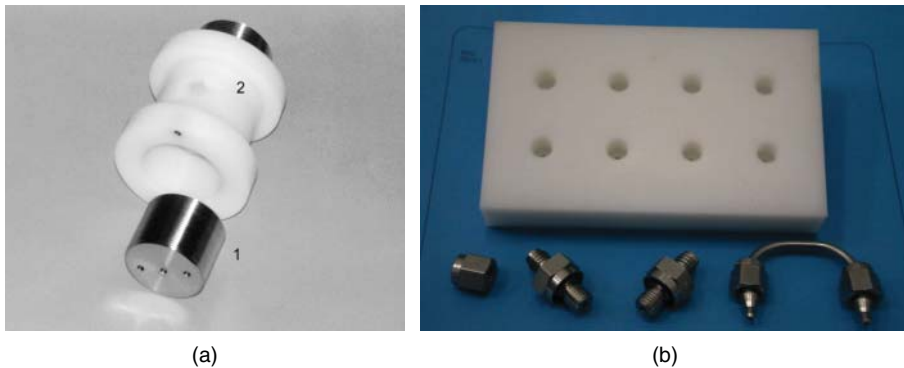

Figure 5.1 (a) Cylindrical chamber (1: chamber, 2: insulator) (Picart, *et al.*, 2002. Reproduced with permission of Elsevier; (b) cofield chamber.

the electric field in the same direction as the fluid flow), coaxial and cylindrical concentric-electrodes (Sobrino-López and Martin-Belloso, 2010) (Figure 5.1). These new designs have allowed a uniform electric field distribution to be applied in larger scale equipment.

New manufacturing materials have been suggested to overcome the metal migration issues encountered with electrodes made from stainless steel, even though recent studies have demonstrated that the metal concentrations of foods treated by PEF are below those legislated for human consumption (Roodenburg *et al.*, 2005a, 2005b). Graphite has been shown to be much more resistant to electrolysis and metal migration (Toepfl *et al.*, 2007; Huang and Wang, 2009).

The main processing parameter in PEF processing is the electric field strength, which is defined by a relationship between the electrical potential difference (V) applied to two electrodes (V) and d is the distance between them (cm). This relationship depends on chamber geometry and in its simpler form for parallel electrodes reads as:

$$E = \frac{V}{d} \quad (5.1)$$

where E is the electric field strength (kV/cm).

The electric field pulses may be applied in the form of exponential decay or square-wave pulses (Evrendilek and Zhang, 2005) (Figure 5.2).

Exponential decay pulses are characterized by a rapid increase in voltage reaching the maximum value, followed by the exponential decrease of voltage. Square-wave pulses, widely applied for pasteurization of liquid food, can be described as the rapid increase of applied voltage, application of the constant voltage for a specified period of time and then the rapid decrease of the applied voltage. Square-wave pulses can be applied in monopolar or bipolar mode depending on the polarity. In the case of the bipolar mode, one positive pulse is followed by one negative consecutive pulse whereas in the case of the monopolar mode, two consecutive positive or negative pulses are applied. Treatment time (μs) is usually defined by multiplying the pulse

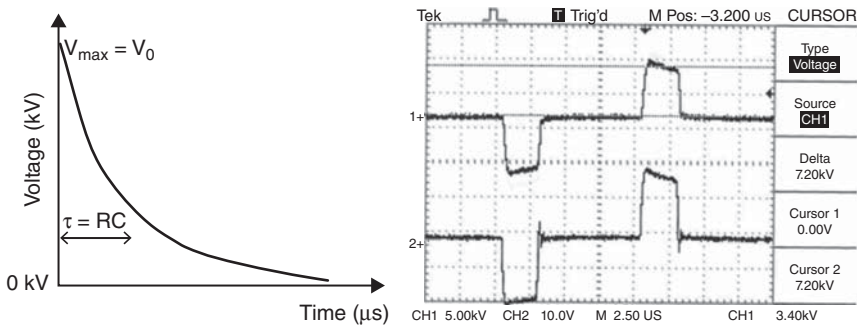

Figure 5.2 (a) Exponential decay pulse; (b) bipolar square-wave pulse.

duration (μs) by the number of pulses (n):

$$t = \tau \cdot n \quad (5.2)$$

where t is the total treatment time (μs), τ is pulse duration (μs) and n is the number of pulses.

Treatment time is also expressed as frequency (Hz) and is defined by the number of pulses per second. Pulse frequency also depends on the flow rate of the liquid food and chamber volume. An oscilloscope is used to monitor voltage, current and pulse duration during the treatment. PEF treatment produces a temperature rise due to ohmic heating and a cooling system is used to minimize the thermal effects. High temperatures increase the electrical conductivity of the product, lowering the maximum electric field strength that is feasible in the treatment chamber before undergoing a ‘dielectric breakdown’ of the system, evidenced by an electric spark. In addition, air bubbles or suspended particles may also produce ‘dielectric breakdown’ phenomenon (Wouters *et al.*, 2001; Picart *et al.*, 2002; Gongora-Nieto *et al.*, 2002).

5.1.2 Processing Equipment

The wide availability in research universities and institutes throughout the world of bench and pilot plant scale PEF systems capable of generating a uniform electric field, has made possible the development of larger units for pilot plant studies and commercial use with overall throughputs ranging from 400 to 2000 l/h (Min *et al.*, 2003a, 2003b) (Figure 5.3). The technology arising from these combined research efforts has been transferred to several companies manufacturing PEF processing units, such as Diversified Technologies Inc. and PurePulse Technologies Inc. in the USA and ScandiNova Systems AB in Sweden with overall flow rates ranging from 400 to 6000 l/h (Kempkes, 2011).

The use of PEF by the juice processing industry became a reality in the USA when several types of fruit juices treated by PEF were commercialized (Clark, 2006); however, the PEF-treated juices are no longer being produced by the firm due to economic



(a)



(b)

Figure 5.3 (a) Bench scale PEF processing unit (OSU 4D, 6 cofield chambers, 12 kV, 30 l/h, bipolar square-wave pulses); (b) commercial scale PEF processing unit (OSU-6, 3 cofield chambers, 60 kV, 2000 l/h, bipolar square-wave pulses).

constraints. The cost of a PEF-processed product by these units was estimated to be 4 ¢ per liter (Huang and Wang, 2009). It is expected that the continuing high number of research studies and commercial efforts will lead to new industrial applications of PEF technology in the near future.

5.2 Application of PEF for Milk Pasteurization

5.2.1 Microbiological Aspects

Most research studies on microbial inactivation by PEF processing concurred that high voltage treatments produce a series of structural and functional changes in the cellular membrane that lead to microorganism death (Mañas and Pagán, 2005). According to the well-known theory proposed by Zimmermann (1986), an external electric field

applied to a system induces a potential difference across the cellular membrane. The maximum potential difference that the membrane can withstand is known as the 'critical transmembrane potential' or 'critical electric field' (E_c) (kV/cm). When the external electric field exceeds E_c , membrane breakdown occurs, leading to the formation of pores. The magnitude of E_c principally depends on the membrane characteristics of the microorganism. Size and shape are also important, with small and/or rod-shaped cells requiring higher E_c values (Qin *et al.*, 1998; Heinz *et al.*, 2001; Toepfl *et al.*, 2007). In general, 'reversible' pores are formed when the external electric field is less than E_c and the membrane returns to its initial form after the treatment. These pores may cause certain sublethal damage leading to cellular death under conditions that induce stress, such as an acidic environment and/or refrigeration temperatures. On the contrary, if the external electric field value is much greater than E_c , 'irreversible' pores are produced leading to the death of the microorganism. Besides structural changes in the membrane, changes have been observed inside the cell after PEF treatment, such as leakage of intracellular material (cytoplasmic contents due to the detachment of the cytoplasm from the cell membrane) and alterations in the cell proteins (Dutreux *et al.*, 2000).

The effectiveness of PEF processing on reducing the microbial load of fluid milk depends upon several factors related to: (i) the process [electric field strength, treatment time, pulse duration and pulse polarity]; (ii) the microorganism [physiological state (spores versus vegetative cells), size and shape of the microbial cell, cell wall characteristics (Gram-positive versus Gram-negative), inoculum size and natural flora versus inoculation tests]; and (iii) milk composition [electrical conductivity and fat content]. Table 5.1 summarizes the results of research studies performed to date on microbial inactivation of milk using continuous PEF processing.

Milk that was inoculated with various levels of pathogens, such as *Escherichia coli*, *Staphylococcus aureus*, *Pseudomonas fluorescens*, *Listeria monocytogenes*, or *Listeria innocua* as a surrogate, and then treated by PEF processing, showed a significant overall reduction in pathogen levels between 2 and more than 5 \log_{10} by applying processing energies in the range 100–550 kJ/l.

The effects of the PEF process parameters on microbial inactivation in milk show that, in general, the higher the electric field and treatment time values applied, the greater the inactivation level produced. As commented earlier in this chapter, a critical electric field value (E_c) needs to be exceeded to produce damage in the cell membrane and microbial death (Castro *et al.*, 1993). In most cases, E values lower than 20 kV/cm do not have any significant effect on microbial inactivation. To minimize the energy usage required and maximize microbial reduction in milk, several studies optimized the PEF processing conditions by using high E values with short treatment times and moderate temperatures (Sampedro *et al.*, 2007; Sepulveda *et al.*, 2009; Guerrero-Beltran *et al.*, 2010). Other studies focused on the effects of the other PEF process parameters such as pulse polarity (monopolar or bipolar) using square-wave pulses on microbial reduction in milk. For example, Evrendilek and Zhang (2005) conducted a study on the inactivation of *Escherichia coli* O157:H7 in skimmed milk that showed a significant reduction of 1.96 \log_{10} after applying bipolar pulses compared to 1.27 \log_{10} for the monopolar configuration. A possible explanation stated by the authors for the increased reduction in *E. coli* O157:H7 with application of the bipolar configuration is that additional stress in the cell membrane occurs because of the alternating changes of the movement of charged molecules by applying one positive followed by one negative pulse, enhancing the membrane permeabilization. The greater

Table 5.1 Effects of PEF processing on inactivation of microorganisms in milk

Bacteria	Sample	Process conditions	Log reductions	Energy usage	References
<i>Listeria innocua</i>	Skimmed milk (0.2% fat)	30–50 kV/cm, 21.2–64 μ s, 22–34°C ¹	2.5 3.4 (PEF + nisin 10 IU/ml)		Calderon-Miranda <i>et al.</i> (1999)
		41 kV/cm, 160 μ s, 37°C ²	3.8 (PEF + nisin 100 IU/ml) 4.0		Dutreux <i>et al.</i> (2000)
		32.5–38.9 kV/cm, 145–290 μ s, 35°C ¹	3.0	200 kJ/l	Fernandez-Molina <i>et al.</i> (2006)
		30–40 kV/cm, 1–75 μ s, 3–53°C ¹	5.5	243–296 kJ/l	Guerrero-Beltran <i>et al.</i> (2010)
<i>Escherichia coli</i>	Skimmed milk (0.2% fat)	41 kV/cm, 160 μ s, 37°C ²	4.5		Dutreux <i>et al.</i> (2000)
		24 kV/cm, 141 μ s ²	1.88	548 kJ/l	Evrndilek and Zhang (2005)
<i>Pseudomonas fluorescens</i>	Skimmed milk (0.2% fat)	35 kV/cm, 188 μ s, 52°C ²	2.2	314 kJ/l	Michalac <i>et al.</i> (2003)
		32.5–38.9 kV/cm, 145–290 μ s, 35°C ¹	3.0	107 kJ/l	Fernandez-Molina <i>et al.</i> , (2006)
	Skimmed milk Whole milk	31–38 kV/cm, 60 μ s, 20°C ¹	1.9		Fernandez-Molina <i>et al.</i> (2005c)
		28 kV/cm, 20 μ s at 15–40°C ² 28, 31 kV/cm, 20 μ s at 15–55°C ²	2.0 (skimmed milk) >3.0 (10 ³ CFU/ml) >5.0 (10 ⁵ CFU/ml)	112 kJ/l	Craven <i>et al.</i> (2008)
<i>Bacillus cereus</i>	Skimmed milk (0.2% fat)	35 kV/cm, 188 μ s, 52°C ²	3.0	314 kJ/l	Michalac <i>et al.</i> (2003)

<i>Streptococcus lactis</i>	Skimmed milk (0.2% fat)	35 kV/cm, 188 μ s, 52 °C ²	0.3	314 kJ/l	Michalac et al. (2003)
<i>Staphylococcus aureus</i>	Skimmed milk (0.2% fat)	35 kV/cm, 1200 μ s, 100 Hz, 25 °C ²	4.5 (PEF, 100 Hz)		Sobrino-Lopez et al. (2006);
		35 kV/cm, 1200 μ s, 75 Hz, 25 °C ²	3.5 (PEF, 75 Hz)		Sobrino-Lopez and Martin-Belloso (2006),
		35 kV/cm, 2400 μ s, 100 Hz, 25 °C ²	4.5 (PEF-1200 μ s + enterocin)		Sobrino-Lopez and Martin-Belloso (2008);
			6.3 (PEF-1200 μ s + enterocin + nisin)		Sobrino-Lopez et al. (2009)
			4.5 (PEF-1200 μ s + lysozyme)		
			6.4 (PEF-1200 μ s + nisin + lysozyme)		
<i>Salmonella enteritidis</i>	Skimmed milk	47 kV/cm, 500 ns, 62 °C ³	2.3		Floury et al. (2006)
<i>Listeria monocytogenes</i>	Whole milk (3.5%)	30 kV/cm, 100 – 600 μ s, 25 – 50 °C ²	4.0		Reina et al. (1998)
	Partially skimmed milk (2%)				
	Skimmed milk (0.2%)				

¹Pilot scale continuous system (100 l/h), coaxial chamber, exponential decay wave

²Bench scale continuous system (30 l/h), coiled chamber, bipolar square wave

³Bench scale continuous system (10 l/h), coaxial chamber, monopolar square wave

effectiveness of the bipolar configuration was also confirmed by Sobrino-López *et al.* (2006) for *S. aureus* inoculated in skimmed milk. Log reductions of *S. aureus* were 3.6 versus 4.5 log₁₀ with the monopolar and bipolar configurations, respectively. Pulse duration has also attracted attention recently for its potential influence on microbial inactivation but controversial results have been obtained thus far. In a study conducted by Sobrino-López *et al.* (2006), application of longer pulses (from 4 to 8 µs) increased the log reduction of *S. aureus* by 1 log₁₀, from 3.3 to 4.3 log₁₀. However, the effects of pulse duration on microbial inactivation have not yet been elucidated. In fact, some studies in other food matrices have shown that pulse width did not have a significant effect on microbial inactivation (Sampedro *et al.*, 2007). The differences among the studies suggest that the effects of pulse duration on microbial inactivation depend on combination with other parameters such as *E* and the total energy applied.

The efficacy of PEF treatment on microbial inactivation also depends greatly on the characteristics of the microorganism, such as its shape and size. In an early study, Grahl and Markl (1996) compared the PEF inactivation of different microbial strains in skimmed milk by estimating the specific critical electric field (*Ec*) values required for inactivation. It was concluded that smaller cells developed a lower electric potential across the cell membrane; thus, *Ec* values were greater, making them more difficult to inactivate than the larger cells. The study did not find significant differences in *Ec* values among bacteria (*E. coli*, *L. brevis*, *P. fluorescens*) but the *Ec* value estimated for yeasts (*S. cerevisiae*) was significantly smaller, indicating the greater inactivation due to its larger size. In addition to microbial cell size, cell wall characteristics also influence the effectiveness of PEF treatment. Gram-positive bacteria are known to be more resistant to electroporation by PEF treatment than Gram-negative due to the thicker cell membrane and greater peptidoglycan content (Hulsheger *et al.*, 1983; Dutreux *et al.*, 2000). The physiological state of the cell (spore versus vegetative state) also influences the effectiveness of PEF treatment. Spores are characterized as being very resistant to different types of environmental stresses and electric voltage is not an exception. Only one study has been conducted on spore inactivation in milk by PEF processing; it showed no inactivation of the endospores of *Clostridium tyrobutyricum* and *Bacillus cereus* after PEF treatment at 22.4 kV/cm (Grahl and Markl, 1996). Research studies conducted to inactivate *B. cereus* spores in other food matrices also showed the negligible effect of PEF processing on spores but germination of the spores was induced in some cases (Pol *et al.*, 2001; Cserhalmi *et al.*, 2002; Shin *et al.*, 2010). Vegetative cells of *B. cereus* inoculated into skimmed milk have been treated by PEF achieving a greater log reduction of 3 log₁₀ after 35 kV/cm at 52°C (Michalac *et al.*, 2003). *Mycobacterium paratuberculosis* has also been inoculated in whole milk and treated by PEF with more than 5 log₁₀ reductions achieved after 30 kV/cm at 50°C. Substantial structural damage was evident (Rowan *et al.*, 2001).

One of the challenges of extending the shelf life of milk is to reduce the natural microbial load in raw milk. In general, results suggest that lower inactivation levels of natural flora are achieved in comparison with inoculation tests with pathogen microorganisms when conducting PEF treatment on raw milk samples. PEF treatment of raw milk has resulted in log reductions of 1–1.4 log₁₀ with or without a preheating step (Smith *et al.*, 2002; Michalac *et al.*, 2003; Flourey *et al.*, 2006). In some cases, no differences in the log reduction of microflora were observed among PEF, low temperature, long time pasteurization (LTLT) (63°C, 30 min) and high temperature, short time pasteurization (HTST) (72°C, 15 s) (Shamsi *et al.*, 2008). The variability of microbial species, the presence of Gram-positive and spore-forming bacteria and physiological

state could be the main reasons for the reduced effectiveness of PEF in raw milk. Sepúlveda-Ahumada *et al.* (2000) and Rodríguez-González *et al.* (2011) have shown that mesophilic bacteria are more resistant to PEF than coliforms or psychrotrophs, due to possible differences in their cell membrane characteristics. Bermúdez-Aguirre *et al.* (2011) also demonstrated that microbial reduction of mesophilic bacteria was less than that for psychrophilic bacteria in whole raw milk (0.4 versus 0.7 log, respectively) and in skimmed raw milk (0.7 versus 3.0 log, respectively) after PEF processing at 46.5 kV/cm and 60°C. Another interesting scenario is assessing the efficacy of PEF treatment on the inactivation of a pathogen in the presence of the native or indigenous microflora of milk (Otunola *et al.*, 2008). Significant differences in the log reduction were achieved when indigenous flora (10^4 – 10^6 CFU/ml) and *E. coli* (5.2 and 5.6 log₁₀) were combined in skimmed milk. The inactivation was lower when *E. coli* and indigenous flora (1.5 log₁₀) were combined in comparison with other studies conducted on single inoculations of *E. coli*, which demonstrated log reductions on the order of 4.5 log₁₀ (Dutreux *et al.*, 2000). The study concluded that microbial community affected the overall efficacy of PEF treatment on reducing a specific pathogen.

The physicochemical characteristics of milk, particularly the electrical conductivity and the fat content, play an important role on the effectiveness of PEF processing for microbial inactivation. One of the earliest studies on the effects of electrical conductivity was performed on PEF inactivation of *Salmonella dublin* in skimmed milk (Sensoy *et al.*, 1997). The study showed that decreasing the medium conductivity increased the inactivation rate even though the same amount of processing energy was applied. The authors explained that decreasing the medium conductivity increased the difference in conductivity between the microorganism and the medium, causing an increase in the osmotic pressure on the membrane, making it more susceptible to PEF treatment. Fat content is another factor related to milk composition that may compromise the efficacy of PEF treatment. Several studies have assessed the possibility that the fat globules of milk have a protective effect on the microorganisms in milk, making them less susceptible to the PEF treatment. Several authors using *E. coli* and static PEF systems (Grahl and Markl, 1996; Martín *et al.*, 1997; Otunola *et al.*, 2008) and the natural microflora in raw whole milk (Bermúdez-Aguirre *et al.*, 2011) have demonstrated the protective effects of fat in preventing the microbial inactivation. However, in contrast, it was noted that PEF continuous processing of milk with different fat contents (3.5, 2 and 0.2%) resulted in no significant differences in log reduction of the inoculated *L. monocytogenes* among the samples (Reina *et al.*, 1998). Sobrino-López *et al.* (2006) obtained similar results for *S. aureus* inoculated in milk samples with different fat contents (0, 1.5 and 3%). In a more detailed study to determine if milk fat has a protective effect on the microorganisms during PEF treatment, Picart (2002) inoculated *L. innocua* in four different samples: dairy cream (20%), whole milk (3.7%), skimmed milk, and phosphate buffer. A comparison of the results obtained at 28–29 kV/cm showed the *L. innocua* inactivation was greater in whole milk than in phosphate buffer but lower in the cream sample showing a protective effect. The authors argued that the protective effects of the fat on microbial inactivation only occurred when a minimum fat content level was achieved. Similar conclusions were reached by Rodríguez-González *et al.* (2011) when comparing raw milk samples with different fat contents (skimmed milk 0.5%, fluid milk 1.0–3.1%) and cream (12.2%) inoculated with native microflora in which lower inactivation levels were achieved in samples with higher fat content being the cream sample the one with the lowest microbial effectiveness due to a combination of high fat content and low electrical conductivity.

The hurdle approach has been proposed as an effective way to enhance the efficacy of nonthermal preservation technologies such as PEF. One of the main strategies to increase the efficiency of PEF processing is to combine the effects of the electric voltage pulses with that of temperature to enhance microbial inactivation. Temperature may decrease the electrical breakdown potential of the membrane making it more susceptible to the electric voltage (Floury *et al.*, 2006). The combination of temperature and PEF processing has also been proposed as an energy saving strategy because fewer pulses or a lower electric field value are required to obtain a certain degree of microbial reduction. Craven *et al.* (2008) studied the inactivation of *Pseudomonas* spp. in skimmed milk after PEF treatment at different processing temperatures in the range 15–55°C. Increasing temperature enhanced inactivation with log reductions of 3.2 and more than 5.0 achieved after 28 and 31 kV/cm at 55°C, respectively. Using this approach, Guerrero-Beltran *et al.* (2010) used a combination of PEF and thermal treatment to inactivate *L. innocua* in whole milk. Increasing the initial temperature (3–53°C) enhanced inactivation and reduced the number of pulses (energy consumption) necessary to achieve a certain degree of inactivation, in this case 5.5 log₁₀. Bermudez-Aguirre *et al.* (2011) found greater inactivation of the natural microflora (mesophilic and psychrophilic bacteria) in skimmed and whole raw milk samples by combining temperature (60°C) and PEF (46.5 kV/cm) achieving a 3.6 log reduction in mesophilic counts and no viable psychrophilic cells.

The combination of PEF technology with antimicrobial/bactericidal compounds has also been proposed by several authors as a hurdle approach. Two main strategies have been proposed to combine synergistically the effects of electric voltage and antimicrobial activity. One approach uses PEF treatment to induce electroporation in the cellular membrane, resulting in larger pores or pores lasting longer (Sobrino-Lopez and Martin-Belloso, 2006) prior to adding the antimicrobial compound, thus facilitating its penetration into the cytoplasmic membrane. Following this hurdle approach strategy, Calderon-Miranda *et al.* (1999) applied a combination of PEF and nisin to inactivate *L. innocua* inoculated into skimmed milk. The authors found a synergetic effect between PEF and nisin occurring only at *E* values greater than 30 kV/cm. This may have been the minimum *E* value necessary to produce pores with a large enough size to allow nisin penetration. On the other hand, some other research studies have proposed the addition of the antimicrobial compound prior to PEF treatment. Smith *et al.* (2002) studied the inactivation of the natural microflora of raw skimmed milk by combining PEF, PEF plus nisin, PEF plus lysozyme and PEF plus both antimicrobial compounds. PEF (80 kV/cm at 52°C) plus lysozyme, PEF plus nisin and PEF plus lysozyme and nisin showed the synergistic effects of PEF plus antimicrobials with log reductions in the natural microflora of 3.2, 5.7 and >7.0 log₁₀, respectively.

Following the same hurdle approach, Sobrino-López *et al.* (2006, 2009; Sobrino-López and Martín-Belloso, 2006) evaluated the combined effects of the antimicrobial compounds enterocin AS-48, nisin and lysozyme and PEF treatment on the inactivation of *S. aureus* in skimmed milk at the natural pH of milk and an acidic pH of 5.0. PEF treatment plus antimicrobials had the same effect on the log reduction of *S. aureus* in skimmed milk regardless of pH. Adding the enterocin compound enhanced the log reduction of *S. aureus* achieved by PEF alone by 1.3 log₁₀, whereas adding nisin plus enterocin enhanced PEF efficacy by doubling the log reduction compared to the PEF and nisin applied alone. The addition of lysozyme did not enhance the log reduction compared to treatment by PEF alone. According to the authors (Sobrino-Lopez *et al.*, 2006, 2009; Sobrino-Lopez and Martin-Belloso, 2006), the benefits of adding

the antimicrobial compound prior to PEF processing were explained by the fact of antimicrobial activity weakening the membrane, thus lowering the value of E_c needed for membrane electroporation and helping to maintain the pores produced by PEF. However, the authors found that the synergism between PEF and antimicrobials was dependent on pH. No enhanced effects were observed at pH 5.0, possibly due to a different conformation of the antimicrobial compound molecule, change of the sensitivity of the cell or recovery from possible sublethal damage. The authors also observed no additional effects after applying PEF treatment prior to adding the antimicrobial compound as the recovery of the damage in the membrane probably occurred immediately after the ending of the treatment enabling bacteriocins to act.

Combination of PEF with other nonthermal technologies has also been assessed as a strategy to improve the effectiveness of nonthermal pasteurization of milk. One of these research studies examined the combined effects of thermosonication (TS) plus PEF treatment on milk pasteurization by using three different experimental protocols (Noci *et al.*, 2009). The first protocol consisted of applying different TS powers (320 and 400 W) and electric field values (30 and 40 kV/cm) at room temperature. Log reductions of native microflora of 4.7 and 6.8 \log_{10} were observed after TS at 320 and 400 W, respectively, followed by PEF at 40 kV/cm. Log reductions in the native microflora were similar to that obtained by thermal pasteurization (72°C, 26 s) (7.0 \log_{10}). In the second protocol, a preheating step (55°C) was conducted prior to TS (400 W) followed by PEF treatment (30 and 40 kV/cm). At 30 kV/cm, the preheating step increased the log reduction by 1.5 \log_{10} (from 3.1 to 4.5) whereas at 40 kV/cm no significant differences in log reduction were noticed between the preheated and unpreheated samples (5.9 and 6.2 \log_{10}). The third protocol assessed the effect of PEF treatment time (energy density) at constant processing conditions consisting of a preheating step at 55°C, TS at 400 W, and PEF at 40 and 50 kV/cm. The increasing energy density led to log reductions of 6.3 and 6.7 \log_{10} after 40 and 50 kV/cm, respectively. In a later study, Rodriguez-Gonzalez *et al.* (2011) combined microfiltration (membrane pore size of 1.4 μm) followed by PEF (32–48 kV/cm, 459–1913 μs) achieving more than a 4 \log_{10} reduction of the natural microflora in raw skimmed milk. The authors found a similar microbial reduction after HTST treatment (72°C, 15 s). These studies have shown that the combination of different nonthermal processes may achieve a microbial effectiveness comparable to thermal processing and may better preserve the fresh characteristics of milk.

5.2.2 Quality Aspects

Quality-Related Enzymes Bacterial enzyme activity can cause important economic losses of food products such as milk because they alter the important quality parameters. Enzyme activity can cause off-flavours, bitter flavours and rancidity. The electric voltage of PEF induces conformational changes and alters the helix alignment of the proteins of quality-related enzymes changing the overall enzyme structure, making difficult the active site–substrate interactions with a loss in the biological activity (Zhang *et al.*, 1995; Bendicho *et al.*, 2003). In general, enzymes are considered more resistant to PEF treatment than microorganisms and complete reduction has not been achieved by PEF processing. PEF processing is less effective than thermal treatment in reducing the activity of milk enzymes. Enzyme inactivation by PEF greatly depends on the type of enzyme and the composition of the matrix.

One of the early studies on PEF inactivation of milk enzymes performed by Bendicho (Bendicho *et al.*, 2003) on a protease from *Bacillus subtilis* inoculated in skimmed and whole milk reached a maximum inactivation of 81% after PEF treatment (20–35.5 kV/cm at 46°C). Pulse duration (4 and 7 μ s) did not have a significant effect when considering the total treatment time. However, when the number of pulses was counted, longer pulses were more effective, achieving similar inactivation by applying fewer pulses. Higher frequencies enhanced the inactivation achieved; however, a correlation was found with the fat content. No significant differences in enzyme inactivation were observed between skimmed and whole milk samples at a low frequency level (67 Hz), but at higher levels (89 and 111 Hz) the enzyme inactivation observed in whole milk was lower than in skimmed milk, possibly due to protection of the enzyme by the milk fat making it more stable. In a later study, Bendicho *et al.* (2005) found no significant inactivation of protease from *B. subtilis* after applying PEF treatment in a batch system (16.4–27.4 kV/cm at 34°C) or continuous bench scale system (20–35.5 kV/cm at 40°C) and slight inactivation (10–15%) in a pilot plant system (26–37 kV/cm at 35°C) compared to LTLT treatment which produced complete inactivation. Shamsi *et al.* (2008) studied the inactivation of alkaline phosphatase in raw skimmed milk by PEF (25–37 kV/cm at 15–60°C) achieving a maximum inactivation of 67%, whereas 98% inactivation was observed after LTLT (63°C, 30 min) and HTST (72°C, 15 s) treatments, respectively. Riener *et al.* (2008) studied the inactivation of lipase, protease, alkaline phosphatase and lactoperoxidase by PEF (15–35 kV/cm at 30°C) achieving inactivation levels of 14.5%, 37.6%, 29% and no effect, respectively. Jaeger *et al.*, (2010) showed inactivation levels of 50 and 60% in lactoperoxidase (LPO) and alkaline phosphatase (ALP) in raw milk after PEF plus heat treatment (34–38 kV/cm at 70–85°C). In general, studies on PEF treatment of enzymes present in milk have shown significant levels of inactivation; however, more research is needed to achieve the inactivation levels of thermal pasteurization.

Physicochemical and Sensory Properties One of the main goals of nonthermal processing is to preserve the original fresh characteristics of the food. These characteristics include the physicochemical properties, such as pH, viscosity, electrical conductivity, protein and fat content, and the sensory properties, such as aroma, flavour and colour, which are the ones of utmost importance in milk. One of the early studies on the effects of PEF processing on the physicochemical parameters of milk found no significant effects on the total solids, pH, electrical conductivity, viscosity, density, colour and particle size after either PEF (35 kV/cm) or thermal processing (73°C, 30 s), possibly due to the mild processing conditions applied (Michalac *et al.*, 2003). Later on, Floury *et al.* (2006) did not find significant effects of PEF processing on the value of pH but a decrease in viscosity was noticed, possibly due to modifications of the hydrodynamic volume of the casein micelles or an alteration in the mineral balance. Further analysis showed that PEF treatment did not affect the mineral balance, since the colloidal calcium fraction remained the same after processing. However, PEF treatment decreased significantly the size of the casein micelles, possibly due to modification of the apparent charge after exposure to high electric fields and modification of the ionic interactions among the caseins. In a study conducted by Odriozola-Serrano *et al.* (2006), comparison of PEF treatment (35.5 kV/cm, 40°C) with traditional thermal pasteurization (75°C, 15 s) showed no significant effects of either process on pH, acidity and free fatty acids content in whole milk.

During storage, significant effects were found between treated and fresh (untreated) samples decreasing the pH and increasing the acidity due to the growth of microorganisms. In addition, the free fatty acid content values increased during storage possibly due to fat degradation by lipases produced by spoilage flora. After PEF and thermal treatment, significant differences in the concentration of whey protein fractions from treated milk samples were observed with the thermally-treated sample having the lowest value of whey protein content due to the protein thermal denaturation. During storage, fresh and PEF-treated samples had a faster whey protein denaturation due to the proteolytic activity of the milk microflora. In a later study conducted by Garcia-Amézquita *et al.* (2009) on fat globule size distribution, a PEF-treated sample at 36–42 kV/cm had a fat globule size distribution similar to that of the LTLT (63°C, 30 min) treated sample regardless of the electric field and number of pulses.

Bermúdez-Aguirre *et al.* (2011) studied the effects of PEF treatment (31–54 kV/cm, 20–40°C) on the pH, electrical conductivity, density, solid not fat content (SNF), colour, fat and protein content in skimmed and whole raw milk samples. Values of the pH and electrical conductivity in PEF-treated samples differed significantly from the untreated samples whereas the densities were not statistically different. Interestingly, SNF, fat and protein content values decreased significantly after PEF treatment, due to electrodeposition of fat and protein on the electrodes. On the other hand, under high electric field values, the fat content values increased after PEF treatment. PEF technology is able to disintegrate the fat by electroporating the fat globule membrane releasing its contents. In this instance, the breakdown or electroporation of the fat globule released its triacylglycerol content to the medium increasing the fat content values. Colour parameters of PEF-treated samples were statistically different from untreated but in general no trend could be observed with the varied experimental parameters. A slight pattern of colour moving to the greenish region was noticed after application of the higher electric field values. The authors attributed this to electrical wearing down of the electrodes followed by the milk constituents reacting with the metallic parts of electrodes producing a green material.

Other physical and rheological properties of milk may be influenced by PEF processing. Modifications in the protein structure of milk induced by PEF processing have been shown to influence the cheese making process and the properties of cheese. Flourey *et al.* (2006) found that PEF treatment increased curd firmness and decreased clotting time, suggesting an increase in the coagulation properties of milk. Yu *et al.* (2009) compared the effects of PEF processing (20–30 kV/cm, 20–50°C) and thermal treatment (63°C, 30 min) in the rennet coagulation properties of milk. The typical curd firmness value decreased after PEF processing; however, the decrease was less pronounced than the thermally treated sample if PEF process temperatures were below 50°C. Rennet coagulation time was influenced by processing and PEF led to a longer coagulation time; however, those changes could be minimized if temperature was below 50°C and electric fields were below 30 kV/cm. Xiang *et al.* (2011) evaluated the flow behaviour of skimmed reconstituted milk after PEF processing (15–20 kV/cm, 35°C). PEF processing affected flow behaviour by increasing the apparent viscosity and consistency index. The authors suggested using PEF processing to alter the rheological properties of milk.

Aroma is one of the sensory properties intimately related to the flavour and overall acceptability of a product. The effects of processing on aroma are usually evaluated through the changes in concentration of the volatile compounds relative to the

fresh sample. Sha *et al.* (2011) compared the volatile compounds profiles of a PEF (15–30 kV/cm, 40°C), HTST (75°C, 15 s) treated and untreated raw milk sample. A total of 37 volatile compounds were extracted and quantified in milk. Thermal and PEF processing resulted in an increase of aldehydes. Heat treatment also increased methyl ketones concentration. No significant changes in acids, lactones or alcohols were detected among the untreated raw, thermally-treated and PEF-treated samples. In addition, olfactometric analysis did not reveal remarkable differences among the samples.

5.2.3 Bioactive Compounds

Preservation of the nutrient content of foods is one of the main advantages of nonthermal processing (Zhang *et al.*, 2011). Research has shown that bioactive compounds such as vitamins and other valuable antioxidant compounds are better preserved by PEF processing in comparison to traditional thermal pasteurization mainly in fruit juices (Sánchez-Moreno *et al.*, 2009; Soliva-Fortuny *et al.*, 2009). In the case of milk, the effects of PEF processing on vitamins (fat soluble and water soluble) were studied by Bendicho *et al.* (2002). Neither PEF (18–27.1 kV/cm at 20–25 and 50–55°C) nor thermal treatment (75°C–15 s, 63°C, 30 min) affected thiamine, riboflavin, cholecalciferol and tocopherol content in milk. Ascorbic acid was the only vitamin affected by processing but without significant differences between the two temperature ranges investigated in PEF treatment. Maximum ascorbic acid degradation was 27.6% after PEF and was similar to HTST treatment. Riener *et al.* (2008) did not find any effect of PEF processing at 35 kV/cm on the vitamins thiamine, riboflavin, and retinol in skimmed milk.

5.2.4 Shelf Life Extension

One of the main challenges of PEF processing is ensuring that the shelf life of milk is the same as or exceeds that of thermally pasteurized milk while preserving its natural properties. Pulsed electric fields processing may be an additional preservation step to extend the shelf life of milk, either immediately after the thermal process prior to packaging or after a short storage time under refrigeration conditions prior to bulk shipping. In two consecutive studies by Fernández-Molina *et al.* (2005a, 2005b) two different processing strategies for extending the shelf life of milk were evaluated. In the first study, the microbiological shelf life of skimmed milk at 4°C was evaluated after processing by thermization (60–65°C, 21 s), PEF (28–36 kV/cm) processing and a combination of PEF followed by thermization. The thermal, PEF and PEF plus thermal processes achieved a log reduction of the natural microflora of 1.69, 2.00 and 2.85 log₁₀, respectively. The shelf life was 14 days for samples treated by PEF or thermization and 30 days for PEF plus thermal processing at 4°C. In the second study, HTST (73–80°C, 6 s), PEF (30–50 kV/cm, 60 µs) and HTST plus PEF processing of skimmed milk were compared and the shelf life determined at 4°C. The PEF-treated sample had a shelf life of 14 days with no coliforms growth whereas after HTST plus PEF (73°C and 50 kV/cm, 80°C and 30 kV/cm) treated samples had a shelf life of 22 and 30 days, respectively. The authors found no significant differences among both processing strategies (HTST plus PEF and PEF plus HTST), arguing that applying thermal processing followed by PEF treatment could damage the bacterial membranes,

making them more susceptible to the electroporation process, whereas PEF followed by thermal processing could inactivate the PEF damaged cells by heat.

The same processing strategy of applying HTST pasteurization followed by PEF and HTST pasteurization followed by PEF after 8 days of milk storage at 4°C, was also used by Sepulveda *et al.* (2005) to estimate the microbiological shelf life of milk samples. The shelf life of milk after applying HTST (72°C, 15 s) plus PEF (35 kV/cm at 65°C) was 60 days whereas HTST plus storage at 4°C (8 days) plus PEF was estimated as 78 days before exceeding the bacterial population limit regulated by the Pasteurized Milk Ordinance (PMO) (FDA, 2011) (2×10^4 CFU/ml of mesophilic bacteria). Comparing those storage periods with the shelf life of an HTST sample, extended shelf lives of more than two weeks and one month were observed with the HTST plus PEF and HTST plus storage plus PEF processing strategies, respectively. The study also followed the visual, olfactory and titratable acidity changes as signs of spoilage during the shelf life. The authors did not observe significant changes except a sweet curdling probably due to the presence of thermophilic *Bacillus* spp. In a later study (Sepulveda *et al.*, 2009), whole raw milk processed by PEF treatment (35 kV/cm, 65°C) achieved a shelf life of 24 days at 4°C whereas a sample processed by thermal pasteurization (72°C, 15 s) achieved a shelf life of 44 days at 4°C (the extended shelf life of the pasteurized sample was probably due to the aseptic conditions used for packaging in the laboratory, which are not used to package HTST-treated milk commercially).

The same processing strategy was also followed by Walkling-Ribeiro *et al.* (2009) on the inactivation of native microbiota inoculated into low-fat UHT milk. After PEF (50 kV/cm at 55°C), HTST (72°C, 26 s) processing and preheating at 50°C followed by PEF treatment (40 kV/cm), log reductions of 6.4–6.7 and 7.0 were achieved, respectively. A whole raw milk sample after preheating plus PEF (preheating at 50°C followed by PEF treatment at 40 kV/cm) and HTST treatments had shelf lives of 21 and 14 d, respectively, before reaching the maximum level of 2.0×10^4 CFU/ml. In a study performed by Craven *et al.* (2008) on the inactivation of *Pseudomonas* spp. inoculated in skimmed milk, samples inoculated with 10^3 CFU/ml and treated by PEF (28 kV/cm at 50 and 55°C, 31 kV/cm at 55°C) reached 10^7 CFU/ml after storage for 7, 9 and 13 days at 4°C, respectively, whereas samples inoculated with 10^5 CFU/ml had shelf lives of 5, 6 and 11 days, respectively, when stored at 4°C. Bermudez-Aguirre *et al.* (2011) performed a microbial shelf life study of PEF-treated (46.5 kV/cm, 60 μ s, 20–60°C) skimmed and whole raw milk samples stored at 4 and 20°C for one month. Microbial counts during storage showed fast microbial growth and shelf life was estimated to be five days at 4°C for the PEF treatment at 60°C in skimmed milk and five days for whole milk processed after PEF treatment at 40°C. At room temperature all PEF treatments showed high microbial counts (10^7 CFU/ml) after two days of storage. In general, the authors attributed the faster microbial growth in the whole milk sample due to the higher nutrients content.

Rodríguez-González *et al.* (2011), Walkling-Ribeiro *et al.* (2011) proposed a combined treatment of PEF (16–42 kV/cm at 40–50°C) and microfiltration (MF) for extending the shelf-life of raw skimmed milk. Firstly, the processing conditions using PEF, MF and thermal processing alone for maximum microbial reduction were determined for raw skimmed milk inoculated with natural microbiota. PEF, MF and thermal pasteurization (75°C, 24 s) alone achieved 2.5, 3.7 and 4.6 log₁₀ of indigenous microflora, respectively. Combined treatment of MF/PEF led to a 4.9 log reduction comparable to the thermal treatment and PEF/MF led to a 7.1 log reduction. As PEF/MF was the most successful hurdle approach, it was used in

a further study to compare the shelf life of PEF/MF-treated samples with those treated by thermal processing of raw skimmed milk. PEF/MF and thermal treatments reduced mesophilic counts by 3.1 and 4.3 \log_{10} , respectively. PEF/MF-treated milk had a shelf life of seven days at 4°C. The shelf life of the thermally treated sample was not provided. The reason for the greater effectiveness of the PEF/MF combination is possibly due to the PEF-induced effects of electrical charge polarization, which induce agglomeration of the microorganisms or of the microorganisms with milk constituents enhancing the efficacy of microfiltration. The authors proposed improving the effectiveness of the process by increasing the temperature of the PEF/MF process to 65°C by preheating the sample or by increasing the PEF power applied. In general, research studies on the shelf life of milk at refrigeration conditions after PEF processing with a preheating step have demonstrated results similar to those of thermal pasteurization. However, research is needed on other important aspects of PEF processing such as consumer preference tests, and additional studies on the effects of PEF processing on the nutritive content, which could shed more light on the boundaries of PEF processing.

5.3 Application of PEF to Dairy Products

5.3.1 Fruit Juice–Milk Beverages

New consumption trends have led consumers to seek healthier and more convenient foods and beverages. Current developments in new ready-to-drink beverages are based on combinations of dairy products and fruit juices with added bioactive components, which are becoming common in markets in Japan, USA and Europe, and have been receiving considerable attention as their market potential grows (Pszczola, 2005). These beverages represent an opportunity for new product development and innovation for both the food industry and scientific community. In a fruit juice and milk combination, the antioxidant capacities of the fruit constituents can be jointly delivered with the health benefits of milk. These products are commonly formulated with pectin as stabilizer, citric acid as acidifier, sugar and a proportion of water. Nevertheless, in the success of commercialization of such products, the technology applied for their preservation is as important as their ingredients and formulation (Granato *et al.*, 2010). Mixed beverages are usually stabilized by thermal processes that partially degrade their nutrient properties. On the other hand, pulsed electric fields technology (PEF) has proven its effectiveness to stabilize microbes and enzymes present in liquid foods with lower degradation of freshness and quality attributes (Heinz *et al.*, 2001). Table 5.2 summarizes the studies conducted in dairy products.

Microbial Inactivation Several studies have been focused on PEF inactivation of pathogenic microorganisms. It has been previously mentioned for fluid milk that microbial inactivation increases with PEF treatment time and electric field strength. Salvia-Trujillo *et al.* (2011) described a 5 log reduction of *L. innocua* in an orange (30%), mango (10%), and apple (10%) fruit juice beverage mixed with whole milk (FJ–WM) or skimmed milk (FJ–SM) after PEF treatment at 35 kV/cm reaching US Food and Drug Administration (FDA, 2004) recommendations for pasteurization

Table 5.2 PEF Processing of dairy-based beverages

Substrate	Parameters measured	Treatment conditions	Shelf life and storage temperatures	References
Fruit juice-milk	Microbiological	35 kV/cm, 1800 μ s, 40°C ² Thermal (90°C, 60 s)	56 d, 4°C	Salvia-Trujillo <i>et al.</i> (2011)
	Enzyme Physicochemical	PME-PG pH, acidity, °Brix, viscosity		
	Microbiological	15–40 kV/cm, 0–2500 μ s, 20°C ²	–	Sampedro <i>et al.</i> (2011)
	Nutrient	15–40 kV/cm, 40–700 μ s, 20°C ²	42 d, 4–10°C	Zulueta <i>et al.</i> (2010b)
	Nutrient, kinetics	Thermal (90°C, 20 s) 15, 25, 35, 40 kV/cm, 40–700 μ s, 20°C ²	42 d, 4–10°C	Zulueta <i>et al.</i> (2010a)
	Enzyme	Thermal (90°C, 20 s) 15–30 kV/cm, 50 μ s, 47.1°C, 62.5°C, 80.3°C ²	–	Sampedro <i>et al.</i> (2009b)
	Physicochemical Enzyme	Thermal (85°C, 60 s) 30 kV/cm, 50 μ s, 80°C ² Thermal (85°C, 66 s)	20 d, 8°C	Sampedro <i>et al.</i> (2009a)
	Physicochemical Microbiological	Volatile compounds PME Volatile compounds Moulds and yeasts, mesophilic bacteria		
	Microbiological, process parameters	35–40 kV/cm, 0–180 μ s, 35°C, 55°C ²	–	Sampedro <i>et al.</i> (2007)

(continued overleaf)

Table 5.2 (continued)

Substrate	Parameters measured	Treatment conditions	Shelf life and storage temperatures	References	
Fruit juice-soya milk	Microbiological, kinetics	<i>E. coli</i>	15–40 kV/cm, 0–700 μ s, 55°C ²	Rivas <i>et al.</i> (2006)	
	Microbiological, kinetics	<i>L. plantarum</i>	15–40 kV/cm, 0–700 μ s, 55°C ²	Sampedro <i>et al.</i> (2006)	
	Nutrient	Fatty acid, mineral profiles	35 kV/cm, 800–1400 μ s, 32°C ² Thermal (90°C, 60 s)	Morales de la Peña <i>et al.</i> (2011)	
	Nutrient	Isoflavone	35 kV/cm, 800–1400 μ s, 32°C ² Thermal (90°C, 60 s)	Morales de la Peña <i>et al.</i> (2010b)	
	Nutrient	Vitamin C, total phenolic content	35 kV/cm, 800–1400 μ s, 32°C ² Thermal (90°C, 60 s)	Morales de la Peña <i>et al.</i> (2010a)	
	Enzyme	POD, LOX			
	Physicochemical	Color, °Brix, pH, acidity, viscosity			
	Microbiological	Moulds and yeasts, psychrophilic bacteria			
	Soya milk	Enzyme, kinetics	LOX	30 kV/cm, 100–600 μ s ²	Li <i>et al.</i> , (2010)
		Enzyme, kinetics	LOX	20–40 kV/cm, 25–100 μ s, 23°C, 35°C, 50°C ³	Riener <i>et al.</i> (2008)
Enzyme, kinetics		LOX	20–40 kV/cm, 0–1100 μ s, 25°C ²	Li <i>et al.</i> (2008)	

Infant formula milk	Microbiological	<i>C. sakazakii</i> , sublethal damage	15, 35 kV/cm, 60-3000 μ s, 15°C ²	24 h, 8°C	Pina-Perez <i>et al.</i> (2009)
	Microbiological, kinetics	<i>C. sakazakii</i>	10–40 kV/cm, 0–3895 μ s, 20°C ²	–	Pina-Perez <i>et al.</i> (2007)
Flavoured milk	Physicochemical	Color, allura red concentration, pH	40 kV/cm, 48 pulses, 2.5 μ s, 55°C ¹	32 d, 4°C	Bermudez-Aguirre <i>et al.</i> (2010)
	Microbiological	Mesophilic bacteria			
Tropical fruit smoothie	Microbiological	<i>E. coli</i> K12	24, 34 kV/cm, 100–150 μ s, 37°C, 46°C, 55°C ³ 45–55°C, 60 s Thermal (72°C, 15 s)	–	Walking-Ribeiro <i>et al.</i> (2008)

¹Pilot scale continuous system, coaxial chamber, exponential decay wave

²Bench scale continuous system, cofield chamber, bipolar square wave

³Bench scale continuous system, cofield chamber, monopolar square wave

of fruit juices. No significant differences in inactivation of *L. innocua* between the skimmed and whole milk formulations were noted despite the fat content of whole milk. This result was also observed by several authors in fluid milk (Reina *et al.*, 1998; Picart *et al.*, 2002; Sobrino-López *et al.*, 2006, Rodríguez-González *et al.*, 2011). *E. coli* inactivation in an orange juice (50%) and milk (20%) mixed beverage has also been studied. A 3.83 log reduction of *E. coli* was described after 15 kV/cm PEF treatment (Rivas *et al.*, 2006). Due to the number of parameters involved in a PEF treatment, making comparisons between the degrees of log reduction found by different authors is usually difficult. In the case of the references mentioned above, although Gram-positive bacteria are commonly more resistant than Gram-negative to PEF treatment, variation in results may be attributed to differences in treatment intensity and in pH of the media.

Salmonella spp. inactivation using PEF treatment was also conducted in an orange juice (30%) milk (20%) beverage (Sampedro *et al.*, 2011). As the pH of juice has great variability during the fruit harvest season and pectin added as stabilizer could vary depending on the different formulations used, both variables could have an effect on food safety. The study was conducted to predict by a Monte Carlo simulation the final load of *Salmonella* Typhimurium cells in the orange juice beverage as influenced by electric field intensity, pH and pectin concentration. A secondary predictive model based on the Weibull distribution function (Weibull, 1951) was used. Together, the models predicted a 5 log reduction for a PEF treatment based on 35 kV/cm, 60 μ s and 40 μ s for pH 4.5 and 3.5 respectively.

From an economical point of view, it is also important to guarantee inactivation of spoilage bacteria that although not involved in food-borne outbreaks could cause important economic losses. In this context, psychrotrophic bacteria, moulds and yeasts counts of a fruit juice–milk beverage (Salvia-Trujillo *et al.*, 2011) were followed during storage time (56 d, 4°C) after a 35 kV/cm PEF treatment, and compared with those obtained after thermal treatment (90°C, 60 s). A shelf life of at least 56 days was found for both samples. A similar study was performed by Sampedro *et al.* (2009a) to follow moulds, yeast and mesophilic microflora counts after a 30 kV/cm PEF treatment and an equivalent thermal treatment at conditions for pectinmethylesterase inactivation (85°C, 66 s). Treated samples were stored at 8–10°C with a shelf life of 2.5 weeks. The differences in microbial stability between both studies could be due to the higher storage temperature and pH in the study by Sampedro *et al.* (2009a).

The effect of PEF process parameters (electric field strength, pulse width, energy applied and temperature) on the inactivation of *Lactobacillus plantarum* was studied in a mixed orange juice–milk beverage (Sampedro *et al.*, 2007). For a given quantity of energy applied, the highest inactivation was achieved with high field intensities and short treatment times. An increase in pulse duration did not produce an increase in inactivation independent of temperature and electric field strength applied. When the process temperature was raised to 55°C, the inactivation increased by 0.5 log₁₀ achieving an energy saving of 60%.

Other studies have focused on the predictive microbiology of PEF inactivation of spoilage bacteria. Sampedro *et al.* (2006) reported *L. plantarum* PEF inactivation kinetics were best modelled using the Weibull distribution function (Weibull, 1951). A parameter deduced from model fitting, mean critical time (*tcw*), was considered as a behaviour index for *L. plantarum* resistance to PEF inactivation. The parameter decreased when electric field strength and treatment temperature increased.

Enzyme Inactivation It is generally believed that food texture and rheology (viscosity) are major determinants of consumer acceptance and preference for food and beverages. In the case of plant-based foods, those parameters are mainly dependent on pectin content and composition in combination with food processing steps. Quality-related enzymes such as pectinmethylesterase (PME) and polygalacturonase (PG) are associated with viscosity and cloud loss of fruit juices and fruit-based beverages due to the catalysis and depolymerization of pectin.

The effect of PEF treatment (15–30 kV/cm at 25, 45 and 65°C initial temperature) on PME inactivation was studied in an orange juice–milk beverage (Sampedro *et al.*, 2009b). At low treatment temperature (25°C) some activation effect was found, as indicated by an increase in PME activity, between 11 and 60%, after the PEF treatment. As mentioned earlier in this chapter, PEF has been applied to improve the extraction of different components by increasing the permeability of plant cells from diverse foodstuffs (Ade-Omowaye *et al.*, 2001). Therefore, application of mild PEF treatments could increase the permeability of the orange pulp by facilitating the release of the bound PME. By increasing the temperature (65°C initial temperature, 80°C final temperature) the inactivation reached a maximum of 91%. To check the thermal effects attributed to temperature in the PEF treatment, a treatment based on low electric field intensities, high frequency and low pulse duration was applied (3–5 kV/cm, 3000–3500 Hz, 1 μ s) obtaining the same final treatment temperature (80°C). Due to the low intensity PEF treatment only thermal effects were observed. The results showed that slight PME inactivation (<10%) was achieved due only to temperature demonstrating the synergetic effect between the temperature and PEF treatment.

Other studies have followed PME activity during shelf life at refrigeration conditions. Sampedro *et al.* (2009a) inactivated 89.4% and 90.1% of PME after thermal (85°C, 66 s) and PEF (30 kV/cm at 65°C) treatment, respectively. During storage (8–10°C, 20 d), enzyme reactivation and phase separation of the orange juice–milk PEF-treated sample were not observed. In the thermally-treated sample, a small amount of precipitate was observed at the bottom of the sample, possibly due to the casein precipitation, although casein is not very sensitive to thermal effects at this temperature but the right pH conditions and temperature will result in precipitation. In a similar manner, PME and PG inactivation was followed in a fruit juice–whole milk (FJ–WM) and in a fruit juice–skimmed milk (FJ–SM) matrix after thermal (90°C, 60 s) and PEF at 35 kV/cm treatments (Salvia-Trujillo *et al.*, 2011). As for PME, no inactivation was detected in FJ–SM while 58.7% inactivation was produced in FJ–WM. Stănciuc *et al.* (2011) reported similar behaviour with lower γ -glutamyl transferase inactivation by heat in skimmed milk in comparison with whole milk or cream. They concluded that such stability increased in matrices with a lower fat content possibly due to the molecular properties of the enzyme itself, but additional studies are needed to verify this hypothesis. As for PG stability, a slight inactivation was reached after PEF treatments independent of the matrices studied (20.93% and 26.92% for FJ–SM and FJ–WM, respectively). During storage, a slight enzyme reactivation in thermally and PEF treated samples was detected. It is known that both treatments produce unfolding of proteins due to changes in their secondary structures; however, there is no available information about whether these changes are persistent during an extended storage period. A posterior folding of the enzyme structure could occur, leading to an increase of its activity.

Nutrient Compounds Degradation The main challenge in developing fruit juice–milk beverages is to better preserve their nutrients and make them more attractive from a sensory viewpoint when compared with traditional thermal processes. In this sense, vitamin retention studies to assess the effects of food processing on the nutritional value of foods are of great importance to food scientists, food industries and consumers. Researchers have used ascorbic acid retention as a quality indicator in fruits and vegetables because it provides an indication of the loss of other vitamins and acts as a valid monitor for the other organoleptic or nutritional components (Ayhan *et al.*, 2001). Zulueta *et al.* (2010a) studied vitamin C retention after thermal (90°C, 20 s) and PEF treatments at 25 kV/cm of a mixed orange juice–milk beverage, observing 86% and 90% retention after each treatment, respectively. The shelf life of thermally and PEF pasteurized beverages stored at 4 and 10°C was estimated as the time for the ascorbic acid concentration to be reduced by 50% in the treated sample. No differences were observed between thermal or PEF treated samples being determined at 52 and 47 days for 4 and 10°C, respectively.

Juices are rich in pigments; specifically, orange juice is a rich source of carotenoids that are one of the main types of natural pigments, colour being one of the principal criteria that govern selection of food products by consumers. Carotenoids have diverse biological functions and actions, such as antioxidant capacity, provitamin A and protection against macular degeneration. Carotenoids are unstable in the presence of light, heat, acids or oxygen; therefore, they should be stabilized to be preserved. The effects of PEF (15–40 kV/cm) and thermal (90°C, 20 s) treatment on the carotenoids content and vitamin A profile of an orange juice–milk beverage after processing and subsequent storage (4–10°C) were evaluated (Zulueta *et al.*, 2010b). The results indicated that the application of the electric field influenced the concentration of the extracted carotenoids, producing a slight increase at 15 kV/cm and a slight decrease at 40 kV/cm. On the other hand, when pasteurization was applied, a reduction in total carotenoids concentration was found. As for degradation during the storage period, carotenoids concentration was less affected in the beverages treated by PEF and were, therefore, maintained in greater quantities throughout storage.

Physicochemical and Sensory Properties Degradation Microbial inactivation and enzyme degradation by food processing are the key parameters to assure food safety and avoid economic losses in the food industry, but nutrient content, physicochemical and sensory properties are the main driving forces for consumers to buy a product. Several research studies have been conducted on the effects of PEF processing on the physicochemical properties of fruit juice–milk beverages. Salvia-Trujillo *et al.* (2011) and Sampedro *et al.* (2009a) followed pH, soluble solids content, colour and titratable acidity parameters in a fruit juice–milk beverage after PEF (35 kV/cm, 1800 μ s and 30 kV/cm, 50 μ s) and thermal treatment (90°C, 60 s and 85°C, 66 s). No significant changes were found between the different treatments or during storage time (56 d, 4°C for treatments applied by Salvia-Trujillo *et al.* (2011) and 20 d, 8°C for treatments applied by Sampedro *et al.* (2009a)).

The aroma of a juice–milk beverage was assessed by analysing the change in concentration of twelve volatile compounds that were extracted by solid phase microextraction (SPME) and selected for quantification by GS–MS following the application of thermal (85°C, 66 s) and PEF treatments (30 kV/cm, 50 μ s at 25°C, 45°C and 65°C) (Sampedro *et al.*, 2009b). The sensitivity of the volatile compounds depended on the applied treatments. The high molecular weight compounds were more resistant to the

thermal treatment and the pulp-related compounds were more resistant to the PEF treatment. Nevertheless, the average loss in volatile compounds concentration was between 16.0 and 43.0% after thermal treatment, and between -13.7 (the negative sign means there was an increase of volatile compounds concentration, probably because of an extraction phenomena produced by PEF treatment) and 8.3%, 5.8 and 21.0% and 11.6 and 30.5% for PEF treatments at 25, 45 and 65°C, respectively. The results showed the potential of PEF treatment for providing an orange juice-milk beverage with a better fresh aroma.

5.3.2 Soya Milk and Fruit Juice–Soya Milk Beverages

Soya milk and soya milk based beverages constitute one of the food industry sectors with the highest worldwide growth and their consumption has experienced a huge increase in the last few years (Sloan 2005). Soya milk, a water extract of soybeans, has an optimal nutritional profile, mainly provided by the isoflavones, which have been associated with low risk of coronary heart disease (Anderson *et al.*, 1995), osteoporosis, menopausal symptoms (Kronenberg, 1994), hormone-dependent cancers, obesity and diabetes (Bathena and Velasquez, 2002), among others. However, marketing of fresh soya milk is a challenge due to its sensitivity to off-flavour development, mainly caused by the enzyme lipoxygenase (LOX, E.C. 1.13.11.12). LOX can be easily inactivated by thermal treatment but results in amino acid degradation and other deteriorative reactions. Two research studies have focused on PEF inactivation of lipoxygenase in soya milk beverages (Li *et al.*, 2008; Riener *et al.*, 2008). Both studies performed a kinetic study to quantify LOX inactivation degree depending on electric field applied and treatment time. Experimental data showed a log-linear trend and were fitted to a first order kinetic model (Riener *et al.*, 2008). Estimated D-values (decimal reduction time) for LOX PEF inactivation were 172.9, 141.6 and 126.1 μ s for 20, 30 and 40 kV/cm, respectively. Maximum LOX inactivation was found to be 84.5% for 40 kV/cm, 100 μ s, with a preheating step at 50°C. Similar inactivation levels (88%) were obtained by Li *et al.* (2008) after treatment of soya milk at 42 kV/cm and room temperature. In this study, the experimental data did not follow a log-linear trend; therefore, the data were fitted to the Weibull distribution function (Weibull, 1951). The kinetic parameter (α) showed a correlation with electric field strength with estimated parameter values of 904.94, 664.27, and 240.67 for 20, 30 and 35 kV/cm, respectively. Further research is needed to determine the effects of PEF on the internal enzyme structure conformation and the mechanisms of enzyme inactivation.

Soya milk has recently been used in the creation of mixed beverages. The effects of PEF treatment (35 kV/cm, 1400 μ s) on the microbial stability, quality parameters and antioxidant properties of a fruit juice (orange, 25%, kiwifruit, 18% and pineapple, 7%) soya milk beverage (FJ–SM) with a storage time of 56 days at 4°C were compared with those of thermal pasteurization (90°C, 60 s) (Morales de la Peña, 2010b). 5 log reductions of *L. innocua* and *L. brevis* were obtained after both treatments and microbial stability was maintained during storage for 56 days at 4°C for both microorganisms as well as for moulds, yeast and psychrophilic microflora. Peroxidase and lipoxygenase were inactivated by 29% and 39%, respectively, after PEF treatment, whereas thermal treatment achieved complete inactivation and 51% inactivation, respectively. Colour, soluble solids, pH and acidity values were not significantly affected by either process. Beverage viscosity increased over time,

regardless of treatment applied. During storage, vitamin C content and antioxidant capacity depleted with time but values were higher in samples treated with PEF than thermally treated. On the other hand, total phenolic compounds did not change over storage time for any of the treatments applied.

The same authors (Morales de la Peña *et al.*, 2011), using the same beverage formulation and treatment conditions (PEF and thermal treatment), conducted a study on the effects of processing and storage time on the isoflavone profile of the beverage. Total isoflavone content was determined by quantification of the aglycone and glucoside forms as analysed by HPLC. Beverages had a higher concentration of the glucoside rather than the aglycone forms. Genistein was the most abundant isoflavone present in the beverages. Both treatments did not cause significant changes in the total isoflavone concentration. During storage the content increased, probably due to the hydrolyzation of the malonyl-isoflavones, and was slightly higher in beverages processed by heat.

The fatty acid and mineral profiles were also determined (Morales de la Peña *et al.*, 2011) using the same beverage formulation and under the same treatment and storage conditions. Linoleic, oleic, linolenic, palmitic and stearic acids were at the highest concentrations in the FJ–SM beverage, whereas calcium and magnesium were identified as the most abundant minerals, irrespective of the treatment applied. The initial concentrations of most of the fatty acids and minerals were not affected by PEF or thermal processes; only elaidic and linoleic acid concentration decreased after PEF or heat treatments. Iron and zinc contents showed a significant increase in untreated and treated beverages. During storage, the minerals remained highly stable while total fatty acid content showed a significant increase in the untreated and treated samples. It was possible that the volatile compounds in the untreated and PEF or thermally-treated beverages underwent biochemical changes resulting in the generation of fatty acids and, consequently, a rise in their concentration throughout the storage time.

5.3.3 Yogurt-Based Beverages

Nonfrozen dairy desserts such as yogurt-based beverages are traditionally considered a healthy food and can be used in various formulations. Their shelf life is limited to three weeks and after that they are often spoiled by yeasts and lactobacilli that can grow in low pH conditions. PEF treatment could be a good candidate to be applied as a preservation method to reduce the quality loss due to microbial spoilage, thus increasing the product shelf life. Yeom *et al.* (2004) studied the shelf life at 4°C of a yogurt-based beverage flavoured with strawberry, grape and blueberry and processed by a combined treatment of heat (60°C, 30 s) plus PEF (30 kV/cm, 32 µs). About 2–4 log reductions in total viable counts and moulds and yeasts were achieved and maintained around 1 log CFU/ml (25 CFU/ml) during the entire storage period of 90 days at 4°C. No significant differences were found between the control and PEF-processed samples after processing and during storage at 4°C in °Brix, pH, appearance, colour, texture, flavour and overall acceptability.

5.3.4 Infant Formula Milk Beverages

Breast milk substitutes have been progressively incorporated into the market as a response to an increasing need for breast milk in those situations where infants do

not have access to it for various reasons. A wide variety of formulas is available, with compositions adapted to different infant needs. Infant formula milk (IFM) can also be formulated in different physical forms, such as powder and liquid (concentrated or ready-to-feed), and in a wide variety of package sizes. Liquid formulas are usually sterile but powdered infant formula milk has an occasional contaminant, *Cronobacter sakazakii*, that can cause a rare but life-threatening form of sepsis, neonatal meningitis, bacteraemia, necrotizing enterocolitis and necrotizing meningoencephalitis after ingestion (Nazarowec-White and Farber, 1997). Public health authorities and researchers are exploring ways of eliminating the bacterium or controlling its growth in IFM. In view of the potential of PEF as a friendly technology in relation to the more sensitive components of foods, research has been carried out to determine the effectiveness of PEF treatments on the inactivation of *C. sakazakii* (Pina-Pérez *et al.*, 2007). IFM was inoculated with 10^4 CFU/ml *C. sakazakii* and treated with PEF at electric field strengths and treatment times that varied from 10 to 40 kV/cm and from 60 to 3895 μ s. The greater the electric field and treatment time, the greater the inactivation reached. The inactivation data were correlated with the different inactivation models, such as the Weibull distribution function (Weibull, 1951) and Bigelow model (Bigelow, 1921), and kinetic constants were calculated for both models. The Weibull model provided the best fit of the experimental data. A maximum of 1.2 log reduction was achieved after 40 kV/cm, 360 μ s. The authors concluded that there were good prospects for the use of PEF in hospitals to achieve safe reconstituted infant formula before storage at refrigerated temperatures.

As commented earlier in this chapter, microbial inactivation by PEF is mainly due to the effects of the treatment on cell membranes causing the formation of pores affecting the integrity and functionality of the membrane. These pores can be reversible or irreversible resulting in this case in death of the cells. On the other hand, microorganisms that survive the treatment may be sublethally damaged, which would require the design of combined processes with a synergistic lethal effect. In this context, Pina-Pérez *et al.* (2009) investigated the occurrence of sublethal damage of *C. sakazakii* in an IFM after PEF treatment and subsequent refrigerated storage. Maximum damage of 90% was found at conditions of minimal inactivation, 15 kV/cm and 3000 μ s. After treatment, samples were stored at 8°C for a period of 24 hours, simulating the period during which baby bottles are stored prior to feeding neonatal babies in hospitals. Untreated cells showed no loss of viability after 24 hours storage, while the fraction of treated damaged cells decreased due to progressive cell death. A log reduction of 0.69 was observed after 15 kV/cm and 3000 μ s and increased up to 2.3 decimal log reduction after 24 hours storage at 8°C, probably due to cells being unable to repair themselves under post-treatment stress conditions. Therefore, a combined treatment (PEF + refrigerated storage) enhances *C. sakazakii* inactivation, which may contribute to reduced neonatal infections.

5.3.5 Other Milk-Based Beverages

In recent years, different fruit smoothies have appeared in the dairy products market as an innovative and attractive way to increase the intake of fruits. These products are characterized by a combination of ingredients that include fruit (and sometimes vegetables), fruit juice, crushed ice, sugar or honey, and some type of thickener such as milk, soya milk, or frozen yogurt to provide milkshake-like consistencies that are thicker than slush drinks. The application of PEF technology to these types

of products would allow extending the shelf life while preserving their sensory properties. The application of moderate heat and PEF in a hurdle approach showed an additive effect by achieving up to 6.9 log CFU/ml inactivation of *E. coli* K12 in a tropical fruit smoothie (pineapple 50%, banana 28%, apple 12%, orange 3% and coconut milk 7%), which was comparable to the bacterial reduction caused by mild thermal pasteurization (72°C, 15 s), thus representing a promising alternative processing technology. A change in preheating temperature from 45 to 55°C and in electric field strength from 24 to 34 kV/cm increased the bactericidal effect of the hurdle treatment (Walking-Ribeiro *et al.*, 2008).

There are also a number of flavoured milks, such as chocolate, vanilla and strawberry among others. Although chocolate is the most popular, especially with children, strawberry flavour also demonstrates a high acceptability with the consumer. Colour of food is an important quality parameter that may determine acceptability or rejection by the consumer. Evrendilek *et al.* (2001) used heat at 105 and 112°C for 31.5 seconds and then PEF (35 kV/cm, 45 µs) in a pilot plant (100l/h) for chocolate milk (skimmed milk added with cocoa powder and sugar). Shelf life was 119, 71 and 28 days for PEF plus heat at 105°C at storage temperatures of 4, 22 and 37°C, respectively, and 119 days for PEF plus heat at 112°C at any of the storage temperatures with no changes in colour. Allura Red AC is an organic molecule, formulated as red powder that is soluble in water, that is used as an additive in coloured beverages. Nevertheless, conventional heat treatment can degrade pigments, which can affect the final product quality. A study conducted by Bermudez-Aguirre *et al.* (2010) aimed to analyse the degradation of Allura Red in strawberry milk under PEF treatment (40 kV/cm at 55°C). After processing, only minor changes were observed in colour, Allura Red concentration and pH. During storage (32 d at 4°C), the samples remained at pH above six. The colour of treated samples showed an important decrease in a^* , hue angle and Chroma. Allura Red concentration versus time followed a biphasic behaviour. The concentration changed, reaching a maximum value during the middle of storage, which decreased at the end of storage time.

5.4 Commercial Applications of PEF for Milk Pasteurization

Traditional thermal pasteurization such as high temperature, short time (HTST) or ultra high temperature (UHT) sterilization of milk has been effectively used for decades as a method for extending the shelf life of fluid milk up to 2.5 weeks or for at least six months, respectively (Sepúlveda *et al.*, 2005). Several authors have proposed alternative methods for milk pasteurization by using PEF treatment. In general, this chapter has shown that the synergistic effect of temperature and PEF treatment favours the inactivation of microorganisms. This synergism has been used for milk processing where a preheating step is used followed by PEF treatment. Figure 5.4 shows an example of a theoretical industrial PEF pasteurization process for milk with heat integration. The system consists of a heat recovery exchanger in which the refrigerated milk exiting the storage tank is pumped and preheated by the hot milk leaving the PEF processing unit. The milk then enters the PEF system designed with three processing units (one pair of chambers per unit, six processing chambers in total) with a heat exchanger after each unit to minimize the heating effects. After leaving the last pair of chambers, the hot milk is routed through the hot

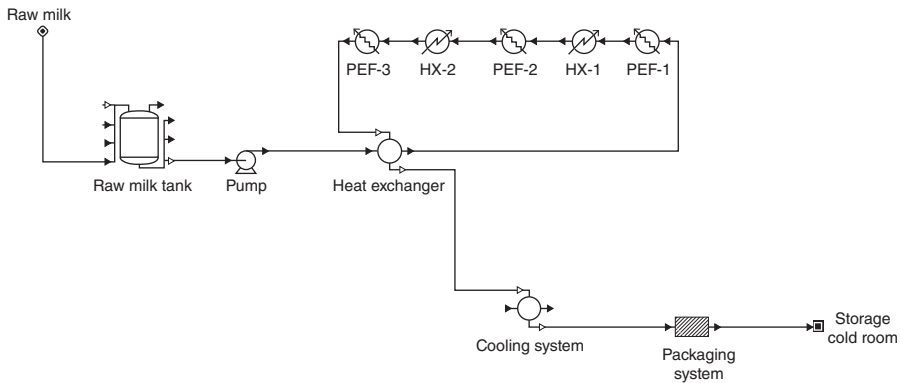

Figure 5.4 Schematic of a commercial PEF system for pasteurization of milk.

side of the heat recovery exchanger, where it is cooled and then passed through a final cooling heat exchanger to reduce its temperature to 7°C before the packaging step and further storage. The temperature used for warming-up the milk before entering the PEF unit may vary from a preheating step at $50\text{--}65^{\circ}\text{C}$ to an HTST treatment (Fernández-Molina *et al.*, 2005b; Sepúlveda *et al.*, 2005; Walkling-Ribeiro *et al.*, 2009). In this case, using a heat exchanger to warm up the milk and taking advantage of the thermal regeneration to heat the milk entering the PEF system has been proposed as an energy effective strategy to reduce the overall energy of the PEF pasteurization process (Sepúlveda *et al.*, 2009; Guerrero-Beltrán *et al.*, 2010).

5.5 Conclusions

Research in recent years has shown that pulsed electric fields processing has the potential for pasteurization of milk with improved preservation of its nutrient content and freshness. PEF treatment has achieved a reduction in the microflora of milk with a shelf life similar to that of HTST pasteurized milk. PEF treatment also has the potential for use in the pasteurization of dairy beverages such as juice–milk products. A combined process of thermal and PEF treatment has been suggested as an effective and energy saving strategy for the industrial pasteurization of milk. Thus, PEF processing in combination with HTST considerably extends the shelf life of refrigerated milk and may be suitable for transporting milk to distant markets. Future applications on the use of PEF for milk and dairy beverages will likely continue to grow as costs decline and food manufacturers identify new applications where PEF can deliver product quality improvements that consumers demand and appreciate.

References

- Ade-Omowaye, B., Angersbach, A., Taiwo, K. and Knorr, D. (2001) Use of pulsed electric field pre-treatment to improve dehydration characteristics of plant based foods, *Trends in Food Science & Technology*, **12**: 285–295.

- Anderson, J.W., Johnstone, B.M. and Cook-Newell, M.E. (1995) Meta-analysis of the effects of soy protein intake on serum lipids, *The New England Journal of Medicine*, **333**: 276–282.
- Ayhan, Z., Yeom, H.W., Zhang, Q.H. and Min, D.B. (2001) Flavor, color and vitamin C retention of pulsed electric field processed orange juice in different packaging materials, *Journal of Agriculture and Food Chemistry*, **49**: 669–674.
- Bathena, S.J. and Velasquez, M.T. (2002) Beneficial role of dietary phytoestrogens in obesity and diabetes, *American Journal Clinical Nutrition*, **76**: 1191–1201.
- Bendicho, S., Espachs, A., Arantegui, J. and Martin, O. (2002) Effect of high intensity pulsed electric fields and heat treatments on vitamins of milk, *Journal of Dairy Research*, **69**: 113–123.
- Bendicho, S., Barbosa-Cánovas, G. and Martin, O. (2003) Reduction of protease activity in milk by continuous flow high-intensity pulsed electric field treatments, *Journal of Dairy Science*, **86**: 697–703.
- Bendicho, S., Marselles-Fontanet, A., Barbosa-Canovas, G. and Martin-Belloso, O. (2005) High intensity pulsed electric fields and heat treatments applied to a protease from *Bacillus subtilis*. A comparison study of multiple systems RID B-8281-2011, *Journal of Food Engineering*, **69**: 317–323.
- Bermudez-Aguirre, D., Yanez, J.A., Dunne, C. *et al.* (2010) Study of strawberry flavored milk under pulsed electric field processing. *Food Research International*, **43**: 2201–2207.
- Bermudez-Aguirre, D., Fernandez, S., Esquivel, H. *et al.* (2011) Milk processed by pulsed electric fields: evaluation of microbial quality, physicochemical characteristics, and selected nutrients at different storage conditions, *Journal of Food Science*, **76**: S289-S299.
- Bigelow, W.D. (1921) The logarithmic nature of thermal death time curves. *Journal of Infectious Disease*, **29**: 528–536.
- Calderon-Miranda, M., Barbosa-Canovas, G. and Swanson, B. (1999) Inactivation of *Listeria innocua* in skim milk by pulsed electric fields and nisin, *International Journal of Food Microbiology*, **51**: 19–30.
- Castro, A.J., Barbosa-Canovas, G.V. and Swanson, B.G. (1993). Microbial inactivation of foods by pulsed electric fields. *Journal of Food Processing and Preservation*, **17**: 47–73.
- Clark, P. (2006) Pulsed electric field processing. *Food Technology*, **60**: 66–67.
- Craven, H., Swiergon, P., Ng, S. *et al.* (2008) Evaluation of pulsed electric field and minimal heat treatments for inactivation of pseudomonads and enhancement of milk shelf-life, *Innovative Food Science and Emerging Technologies*, **9**: 211–216.
- Cserhalmi, Z.S., Vidacs, I., Beczner, J. and Czukor, B. (2002) Inactivation of *Saccharomyces cerevisiae* and *Bacillus cereus* by pulsed electric fields technology, *Innovative Food Science and Emerging Technology*, **3**: 41–45.
- Dutreux, N., Notermans, S., Wijtzes, T. *et al.* (2000) Pulsed electric fields inactivation of attached and free-living *Escherichia coli* and *Listeria innocua* under several conditions, *International Journal of Food Microbiology*, **54**: 91–98.
- Evretdilek, G.A. and Zhang, Q.H. (2005) Effects of pulse polarity and pulse delaying time on pulsed electric fields-induced pasteurization of *E. coli* O157:H7, *Journal of Food Engineering*, **68**: 271–276.
- Evretdilek, G., Dantzer, W., Streaker, C. *et al.* (2001) Shelf-life evaluations of liquid foods treated by pilot plant pulsed electric field system. *Journal of Food Process Preservation*, **25**: 283–297.

- Fernandez-Molina, J.J., Barbosa-Cánovas, G.V. and Swanson, B.G. (2005a) Skim milk processing by combining pulsed electric fields and thermal treatments, *Journal of Food Processing and Preservation*, **29**: 291–306.
- Fernandez-Molina, J.J., Fernandez-Gutierrez, S.A., Altunakar, B. *et al.* (2005b) The combined effect of pulsed electric fields and conventional heating on the microbial quality and shelf life of skim milk, *Journal of Food Processing and Preservation*, **29**: 390–406.
- Fernandez-Molina, J.J., Altunakar, B., Bermudez-Aguirre, D. *et al.* (2005c) Inactivation of *Pseudomonas fluorescens* in skim milk by combinations of pulsed electric fields and organic acids. *Journal of Food Protection*, **68** (6): 1232–1235.
- Fernandez-Molina, J., Bermudez-Aguirre, D., Altunakar, B. *et al.* (2006) Inactivation of *Listeria innocua* and *Pseudomonas fluorescens* by pulsed electric fields in skim milk: Energy requirements, *Journal of Food Process Engineering*, **29**: 561–573.
- Floury, J., Grosset, N., Leconte, N. *et al.* (2006) Continuous raw skim milk processing by pulsed electric field at non-lethal temperature: effect on microbial inactivation and functional properties, *Lait*, **86**: 43–57.
- FDA (Food and Drug Administration) (2004) Guidance for industry: Juice HACCP hazards and controls guidance first edition; final guidance. www.fda.gov/food/guidance/regulation/guidancedocumentsregulatoryinformation/ucm072557.htm(last accessed 2 January 2015).
- FDA (Food and Drug Administration) (2011) Grade “A”, Pasteurized Milk Ordinance. US Department of Health and Human Services. Public Health Service. <http://www.fda.gov/downloads/Food/FoodSafety/Product-SpecificInformation/MilkSafety/NationalConferenceonInterstateMilkShipmentsNCIMSMModelDocuments/UCM291757.pdf> (last accessed 2 January 2015).
- García-Amezquita, L.E., Primo-Mora, A.R., Barbosa-Cánovas, G.V. and Sepulveda, D.R. (2009) Effect of nonthermal technologies on the native size distribution of fat globules in bovine cheese-making milk, *Innovative Food Science and Emerging Technologies*, **10**: 491–494.
- Gongora-Nieto, M.M., Sepulveda, D.R., Pedrow, P. *et al.* (2002) Food processing by pulsed electric fields: Treatment delivery, inactivation level, and regulatory aspects, *LWT – Food Science and Technology*, **35**, 375–388.
- Grahl, T. and Markl, H. (1996) Killing of microorganisms by pulsed electric fields, *Applied Microbiology and Biotechnology*, **45**: 148–157.
- Granato, D., Branco, G.F. and Cruz, A.G. (2010) Probiotic dairy products as functional foods, *Comprehensive Reviews in Food Science and Food Safety*, **9**: 455–70.
- Guderjan, M., Topfl, S., Angersbach, A. and Knorr, D. (2005) Impact of pulsed electric field treatment on the recovery and quality of plant oils, *Journal of Food Engineering*, **67**: 281–287.
- Guerrero-Beltran, J.A., Sepulveda, D.R., Gongora-Nieto, M.M. *et al.* (2010) Milk thermization by pulsed electric fields (PEF) and electrically induced heat, *Journal of Food Engineering*, **100**: 56–60.
- Heinz, V., Alvarez, I., Angersbach, A. and Knorr, D. (2001) Preservation of liquid foods by high intensity pulsed electric fields – basic concepts for process design, *Trends in Food Science & Technology*, **12**: 103–111.
- Huang, K. and Wang, J. (2009) Designs of pulsed electric fields treatment chambers for liquid foods pasteurization process: A review, *Journal of Food Engineering*, **95**: 227–239.

- Hülshager, H., Potel, J. and Niemann, E. (1983) Electric-field effects on bacteria and yeast-cells, *Radiation and Environmental Biophysics*, **22**: 149–162.
- Jaeger, H., Meneses, N., Moritz, J. and Knorr, D. (2010) Model for the differentiation of temperature and electric field effects during thermal assisted PEF processing, *Journal of Food Engineering*, **100**: 109–118.
- Kempkes, M.A. (2011) Pulsed electric field (PEF) systems for commercial food and juice processing. In: *Case Studies in Novel Food Processing Technologies* (eds C.J. Doona, K. Kustin and F.E. Feeherry). Woodhead Publishing, Cambridge, pp. 73–102.
- Kronenberg, F. (1994) Hot flashes. In: *Treatment of the Postmenopausal Woman* (ed. R.A. Lobo). Raven Press, New York, pp. 97–116.
- Li, Y.Q., Chen, Q., Liu, X.H. and Chen, Z.X. (2008) Inactivation of soybean lipoxygenase in soymilk by pulsed electric fields, *Food Chemistry*, **109**: 408–414.
- Li, Y.Q., Tian, W.L. and Liu, X.E. (2010) Modelling the inactivation of PEF frequency and width for soybean lipoxygenase in soymilk, *Agro Food Industry Hi-Tech*, **21**: 42–44.
- Mañas, P. and Pagan, R. (2005) Microbial inactivation by new technologies fo food preservation, *Journal of Applied Microbiology*, **98**: 1387–1399.
- Martin, O., Qin, B., Chang, F. *et al.* (1997) Inactivation of *Escherichia coli* in skim milk by high intensity pulsed electric fields, *Journal of Food Process Engineering*, **20**: 317–336.
- Michalac, S., Alvarez, V., Ji, T. and Zhang, Q. (2003) Inactivation of selected microorganisms and properties of pulsed electric field processed milk, *Journal of Food Processing and Preservation*, **27**: 137–151.
- Min, S., Jin, Z., Min, S. *et al.* (2003a) Commercial-scale pulsed electric field processing of orange juice, *Journal of Food Science*, **68**: 1265–1271.
- Min, S., Jin, Z. and Zhang, Q. (2003b) Commercial scale pulsed electric field processing of tomato juice, *Journal of Agricultural and Food Chemistry*, **51**: 3338–3344.
- Morales-de la Pena, M., Salvia-Trujillo, L., Rojas-Graue, M.A. and Martin-Belloso, O. (2010a) Impact of high intensity pulsed electric field on antioxidant properties and quality parameters of a fruit juice-soymilk beverage in chilled storage, *Food Science and Technology*, **43**: 872–881.
- Morales-de la Pena, M., Salvia-Trujillo, L., Rojas-Graue, M.A. and Martin-Belloso, O. (2010b) Isoflavone profile of a high intensity pulsed electric field or thermally treated fruit juice-soymilk beverage stored under refrigeration, *Innovative Food Science and Emerging Technologies*, **11**: 604–610.
- Morales-de la Pena M., Salvia-Trujillo, L., Rojas-Graue, M.A., and Martín-Belloso, O. (2011) Impact of high intensity pulsed electric fields or heat treatments on the fatty acid and mineral profiles of a fruit juice-soymilk beverage during storage, *Food Control*, **22**: 1975–1983.
- Nazarowec-White, M. and Farber, J.M. (1997) *Enterobacter sakazakii*: a review, *Journal of Food Engineering*, **15**: 207–214.
- Noci, F., Walkling-Ribeiro, M., Cronin, D. *et al.* (2009) Effect of thermosonication, pulsed electric field and their combination on inactivation of *Listeria innocua* in milk, *International Dairy Journal*, **19**: 30–35.
- Odriozola-Serrano, I., Bendicho-Porta, S. and Martin-Belloso, O. (2006) Comparative study on shelf life of whole milk processed by high-intensity pulsed electric field or heat treatment, *Journal of Dairy Science*, **89**: 905–911.
- Otunola, A., El-Hag, A., Jayaram, S. and Anderson, W.A. (2008) Effectiveness of pulsed electric fields in controlling microbial growth in milk, *International Journal of Food Engineering*, **4**, 1–14.

- Picart, L., Dumay, E. and Cheftel, J.C. (2002) Inactivation of *Listeria innocua* in dairy fluids by pulsed electric fields: influence of electric parameters and food composition, *Innovative Food Science and Emerging Technologies*, **3**: 357–369.
- Pina Pérez, M., Rodrigo Aliaga, D., Ferrer Bernat, C. *et al.* (2007) Inactivation of *Enterobacter sakazakii* by pulsed electric field in buffered peptone water and infant formula milk, *International Dairy Journal*, **17**: 1441–1449.
- Pina-Perez, M., Rodrigo, D., and Martinez Lopez, A. (2009) Sub-lethal damage in *Cronobacter sakazakii* subsp *sakazakii* cells after different pulsed electric field treatments in infant formula milk, *Food Control*, **20**: 1145–1150.
- Pol, I., van Arendonk, W., Mastwijk, H.C. *et al.* (2001) Sensitivities of germinating spores and carvacrol-adapted vegetative cells and spores of *Bacillus cereus* to nisin and pulsed-electric-field treatment, *Applied and Environmental Microbiology*, **67**: 1693–1699.
- Pszczola, D.E. (2005) Ingredients. *Making fortification*, *Food Technology*, **59**: 44–61.
- Qin, B., Barbosa-Canovas, G., Swanson, B. *et al.* (1998) Inactivating microorganisms using a pulsed electric field continuous treatment system, *IEEE Transactions on Industry Applications*, **34**: 43–50.
- Reina, L., Jin, Z., Zhang, Q. and Yousef, A. (1998) Inactivation of *Listeria monocytogenes* in milk by pulsed electric field, *Journal of Food Protection*, **61**: 1203–1206.
- Riener, J., Noci, F., Cronin, D.A. *et al.* (2008) Combined effect of temperature and pulsed electric fields on soya milk lipoxigenase inactivation, *European Food Research and Technology*, **227**: 1461–1465.
- Rivas, A., Sampedro, F., Rodrigo, D. *et al.* (2006) Nature of the inactivation of *Escherichia coli* suspended in an orange juice and milk beverage. *European Food Research and Technology*, **223**: 541–545.
- Rodriguez-Gonzalez, O., Walkling-Ribeiro, M., Jayaram, S. and Griffiths, M.W. (2011) Factors affecting the inactivation of the natural microbiota of milk processed by pulsed electric fields and cross-flow microfiltration, *Journal of Dairy Research*, **78**: 270–278.
- Roodenburg, B., Morren, J., Berg, H. and de Haan, S. (2005a) Metal release in a stainless steel pulsed electric field (PEF) system Part I. Effect of different pulse shapes; theory and experimental method, *Innovative Food Science and Emerging Technologies*, **6**: 327–336.
- Roodenburg, B., Morren, J., Berg, H. and de Haan, S. (2005b) Metal release in a stainless steel pulsed electric field (PEF) system Part II. The treatment of orange juice; related to legislation and treatment chamber lifetime, *Innovative Food Science and Emerging Technologies*, **6**: 337–345.
- Rowan, N., MacGregor, S., Anderson, J. *et al.* (2001) Inactivation of *Mycobacterium paratuberculosis* by pulsed electric fields, *Applied and Environmental Microbiology*, **67**: 2833–2836.
- Salvia-Trujillo, L., Morales-de la Pena, M., Rojas-Graue, M.A. and Martín-Belloso, O. (2011) Microbial and enzymatic stability of fruit juice-milk beverages treated by high intensity pulsed electric fields or heat during refrigerated storage, *Food Control* **22**: 1639–1646.
- Sampedro, F., Rivas, A., Rodrigo, D. *et al.* (2006) Effect of temperature and substrate on PEF inactivation of *Lactobacillus plantarum* in an orange juice-milk beverage. *European Food Research and Technology*, **223**: 30–34.
- Sampedro, F., Rivas, A., Rodrigo, D. *et al.* (2007) Pulsed electric fields inactivation of *Lactobacillus plantarum* in an orange juice-milk based beverage: Effect of process parameters, *Journal of Food Engineering*, **80**: 931–938.

- Sampedro, F., Geveke, D., Fan, X. *et al.* (2009a) Shelf-life study of an orange juice-milk based beverage after PEF and thermal processing, *Journal of Food Science*, **74**: S107-112.
- Sampedro, F., Geveke, D.J., Fan, X. and Zhang, H.Q. (2009b) Effect of PEF, HHP and thermal treatment on PME inactivation and volatile compounds concentration of an orange juice-milk based beverage, *Innovative Food Science and Emerging Technology*, **10**: 463-469.
- Sampedro, F., Rodrigo, D. and Martinez, A. (2011) Modelling the effect of pH and pectin concentration on the PEF inactivation of *Salmonella enterica* serovar Typhimurium by using the Monte Carlo simulation, *Food Control* **22**: 420-425.
- Sánchez-Moreno, C., De Ancos, B., Plaza, L. *et al.* (2009) Nutritional approaches and health-related properties of plant foods processed by high pressure and pulsed electric fields, *Critical Reviews in Food Science and Technology*, **49**: 552-576.
- Sensoy, I., Zhang, Q.H. and Sastry, S.K. (1997) Inactivation kinetics of *Salmonella dublin* by pulsed electric field, *Journal of Food Process Engineering*, **20**: 367-381.
- Sepulveda, D.R., Gongora-Nieto, M.M., Guerrero, J.A. and Barbosa-Canovas, G.V. (2005) Production of extended-shelf life milk by processing pasteurized milk with pulsed electric fields, *Journal of Food Engineering*, **67**: 81-86.
- Sepulveda, D.R., Gongora-Nieto, M.M., Guerrero, J.A. and Barbosa-Canovas, G.V. (2009) Shelf life of whole milk processed by pulsed electric fields in combination with PEF-generated heat, *LWT - Food Science and Technology*, **42**: 735-739.
- Sepulveda-Ahumada, D., Ortega-Rivas, E. and Barbosa-Canovas, G. (2000) Quality aspects of cheddar cheese obtained with milk pasteurized by pulsed electric fields, *Food and Bioproducts Processing*, **78**: 65-71.
- Sha, Z., Ruijin, Y., Wei, Z. *et al.* (2011) Influence of pulsed electric field treatments on the volatile compounds of milk in comparison with pasteurized processing, *Journal of Food Science*, **76**: C127-C132.
- Shamsi, K., Versteeg, C., Sherkat, F. and Wan, J. (2008) Alkaline phosphatase and microbial inactivation by pulsed electric field in bovine milk, *Innovative Food Science and Emerging Technologies*, **9**: 217-223.
- Shin, J.K., Lee, S.J., Cho, H.Y. *et al.* (2010). Germination and subsequent inactivation of *Bacillus subtilis* spores by pulsed electric field treatment, *Journal of Food Processing and Preservation*, **34**: 43-54.
- Sloan, A. (2005) Top 10 global food trends. *Food Technology*, **59**: 20-32.
- Smith, K., Mittal, G. and Griffiths, M. (2002) Pasteurization of milk using pulsed electrical field and antimicrobials, *Journal of Food Science*, **67**: 2304-2308.
- Sobrinho-Lopez, A. and Martin-Belloso, O. (2006) Enhancing inactivation of *Staphylococcus aureus* in skim milk by combining high-intensity pulsed electric fields and nisin, *Journal of Food Protection*, **69**: 345-353.
- Sobrinho-Lopez, A. and Martin-Belloso, O. (2008) Enhancing the lethal effect of high-intensity pulsed electric field in milk by antimicrobial compounds as combined hurdles, *Journal of Dairy Science*, **91** (5): 1759-1768.
- Sobrinho-Lopez, A. and Martin-Belloso, O. (2010) Review: Potential of high-intensity pulsed electric field technology for milk processing, *Food Engineering Reviews*, **2**: 17-27.
- Sobrinho-Lopez, A., Raybaudi-Massilia, R. and Martin-Belloso, O. (2006) High-intensity pulsed electric field variables affecting *Staphylococcus aureus* inoculated in milk, *Journal of Dairy Science*, **89**: 3739-3748.
- Sobrinho-Lopez, A., Viedma-Martinez, P., Abriouel, H. *et al.* (2009) The effect of adding antimicrobial peptides to milk inoculated with *Staphylococcus aureus* and processed by high-intensity pulsed-electric field, *Journal of Dairy Science*, **92**: 2514-2523.

- Soliva-Fortuny, R., Balasa, A., Knorr, D. and Martin-Belloso, O. (2009) Effects of pulsed electric fields on bioactive compounds in foods: a review RID C-9673-2011 RID B-8281-2011, *Trends in Food Science & Technology*, **20**: 544–556.
- Stânciuc, N., Dumitrascu, L., Râpeanu, G. and Stanciu, S. (2011) γ -Glutamyl transferase inactivation in milk and cream: a comparative kinetic study, *Innovative Food Science and Emerging Technology*, **12**: 56–61.
- Toepfl, S., Heinz, V. and Knorr, D. (2007) High intensity pulsed electric fields applied for food preservation, *Chemical Engineering and Processing*, **46**: 537–546.
- Vega-Mercado, H., Martin-Belloso, O., Qin, B. *et al.* (1997) Non-thermal food preservation: Pulsed electric fields RID B-8281-2011, *Trends in Food Science and Technology*, **8**: 151–157.
- Walkling-Ribeiro, M., Noci, F., Cronin, D. *et al.* (2008) Inactivation of *Escherichia coli* in a tropical fruit smoothie by a combination of heat and pulsed electric fields, *Journal of Food Science*, **73**: M395-399.
- Walkling-Ribeiro, M., Noci, F., Cronin, D. *et al.* (2009) Antimicrobial effect and shelf-life extension by combined thermal and pulsed electric field treatment of milk, *Journal of Applied Microbiology*, **106**: 241–248.
- Walkling-Ribeiro, M., Rodriguez-Gonzalez, O., Jayaram, S. and Griffiths, M.W. (2011) Microbial inactivation and shelf life comparison of 'cold' hurdle processing with pulsed electric fields and microfiltration, and conventional thermal pasteurisation in skim milk, *International Journal of Food Microbiology*, **144**: 379–386.
- Weibull, W. (1951) A statistical distribution function of wide applicability, *Journal of Applied Mechanics*, **51**: 93–97.
- Wouters, P., Alvarez, I. and Raso, J. (2001) Critical factors determining inactivation kinetics by pulsed electric field food processing, *Trends in Food Science and Technology*, **12**: 112–121.
- Xiang, B., Simpson, M.V, Ngadi, M. and Simpson, B. (2011) Flow behavior and viscosity of reconstituted skimmed milk treated with pulsed electric field, *Biosystems Engineering*, **109**: 228–234.
- Yeom, H., Evrendilek, G., Jin, Z. and Zhang, Q. (2004) Processing of yogurt-based products with pulsed electric fields: Microbial, sensory and physical evaluations, *Journal of Food Processing and Preservation*, **28**: 161–178.
- Yu, L., Ngadi, M. and Raghavan, G. (2009) Effect of temperature and pulsed electric field treatment on rennet coagulation properties of milk, *Journal of Food Engineering*, **95**: 115–118.
- Zhang, H.Q., Barbosa-Cánovas, G. and Swanson, B. (1995) Engineering aspects of pulsed electric-field pasteurization, *Journal of Food Engineering*, **25**: 261–281.
- Zhang, S., Yang, R., Zhao, W. *et al.* (2011) Influence of pulsed electric field treatments on the volatile compounds of milk in comparison with pasteurized processing, *Journal of Food Science*, **76**: 127–132.
- Zimmermann, U. (1986) Electrical breakdown, electropermeabilization and electrofusion, *Reviews of Physiology Biochemistry and Pharmacology*, **105**: 176–256.
- Zulueta, A., Esteve, M.J. and Frigola, A. (2010a) Ascorbic acid in orange juice-milk beverage treated by high intensity pulsed electric fields and its stability during storage. *Innovative Food Science and Emerging Technology*, **11**: 84–90.
- Zulueta, A., Barba, F.J., Esteve, M.J. and Frigola, A. (2010b) Effects on the carotenoid pattern and vitamin A of a pulsed electric field-treated orange juice-milk beverage and behavior during storage. *European Food Research and Technology*, **231**: 525–534.

6

High Power Ultrasound Processing in Milk and Dairy Products

Bogdan Zisu^{1,2} and Jayani Chandrapala^{3,4}

¹*Dairy Innovation Australia Ltd, Australia*

²*School of Applied Sciences, College of Science, Engineering and Health, RMIT University, Australia*

³*School of Chemistry, University of Melbourne, Australia*

⁴*Advanced Food Systems Research Unit, College of Health and Biomedicine, Victoria University, Australia*

6.1 Introduction: Ultrasound in Dairy

Ultrasound has been known to create material changes through physical and chemical reactions since the late 1920s (Wood and Loomis, 1927). However, the science and equipment behind the technology only began evolving in the 1970s. Many of today's popular commercial applications are not associated with food and remain similar to those that evolved early, primarily in the areas of ultrasonic cleaning and plastic welding (Dolatowski *et al.*, 2007).

The appeal of ultrasound as a processing technique has to do with the perception that sound waves are generally regarded as safe, unlike other technologies such as microwaves, which may be perceived in a less friendly manner. Despite this, the food industry has been slow to embrace this technology. However, the scientific community has seen a recent resurgence in ultrasonic research over the past decade and the technology has rapidly emerged as a mild nonthermal processing tool capable of replacing or assisting many conventional food processing applications, such as emulsification, homogenization (Wu *et al.*, 2001), mixing, milling, extraction, pasteurization, filtration, moisture removal for drying (Mulet *et al.*, 2003) and crystallization (Luque de Castro and Prirgo-Capote, 2007), and may be used in equipment cleaning (Earnshaw,

1998; Ashokkumar *et al.*, 2008). Many of these applications remain at the exploratory stage with few making the transition to commercial processing.

Ultrasound is similar to all sound waves, that is the frequency of sound waves that define 'ultrasound', which is emitted above the human hearing range (20 Hz to about 20 kHz), are simply longitudinal pressure waves transmitted through a medium. Ultrasound when used as a processing tool is generally regarded as the sound waves emitted in the frequency range 20 kHz to 1 MHz, also known as 'power ultrasound', with the majority of food applications ranging in frequency between 20 and 40 kHz (Mason, 1998) due to powerful cavitation effects (Hem, 1967; Earnshaw, 1998). Power ultrasound is different from diagnostic ultrasound, which uses frequencies above 1 MHz.

High intensity ultrasound at a frequency of ≥ 20 kHz is transmitted as a series of compression and rarefaction cycles that generate acoustic cavitation. In an acoustic field, microbubbles in solution may undergo growth by rectified diffusion and by bubble–bubble coalescence (Ciawi *et al.*, 2006). Cavitation bubbles reach a maximum size and violently collapse, generating mechanical, physical and chemical effects, such as shockwave formation and turbulent motion (Ashokkumar *et al.*, 2004), powerful enough to break large aggregates apart (Ashokkumar *et al.*, 2009b). At the point of bubble collapse, high localized temperatures are generated and these may cause chemical changes, primarily by generating radicals as described in detail by others (Ashokkumar and Mason, 2007). In an aqueous environment the amount of hydrogen (H) and hydroxyl (OH) radicals produced is dependent on frequency and most are produced at the intermediate frequency range of 200–500 kHz (Ashokkumar *et al.*, 2008). Low frequencies (20–100 kHz), typical of most food applications, generally emit high pressures (70–100 MPa) (Laborde *et al.*, 1998) generating shockwaves, turbulence and physical effects through transient cavitation and these dominate over chemical effects.

Although ultrasound as a technology has yet to find widespread acceptance in the dairy industry, with the technology occasionally finding industrial use on a small scale for cleaning, several promising laboratory studies have emerged due to improved process efficiency, such as the ability to manufacture products with 'tailored' functionality, microbial reduction, the ability to control enzymes and the capability of improving microstructure through component interactions. Ultrasound-induced physical effects are used in dairy applications to improve whey ultrafiltration (Muthukumar *et al.*, 2004, 2005a, 2005b, 2007), reduce product viscosity (Ashokkumar *et al.*, 2009a, 2009b; Zisu *et al.*, 2010; Bates and Bagnall, 2011) and manufacture yogurts with tailored rheological properties and shorter fermentation times (Vercet *et al.*, 2002; Reiner *et al.*, 2009b, 2010). These are but a few potential applications and others are discussed in this chapter. Recent studies have also shown scale-up potential using sonicators with the capacity to deliver up to 4 kW of power where the viscosity and functional characteristics of dairy protein solutions were modified (Zisu *et al.*, 2010). Factors affecting the functional properties of sonicated proteins include structure and physicochemical properties, surface hydrophobicity and hydrophobic and hydrophilic interactions and free thiols. The size, conformation and flexibility of macromolecules and environmental and compositional conditions are also key parameters. These factors determine the balance of attractive and repulsive forces between the proteins and control the extent of protein–solvent and protein–protein interactions. This chapter explores the above mentioned dairy applications in response to ultrasound treatment in a more descriptive manner.

6.2 Ultrasonic Equipment

Sonicators were never designed with food processing in mind and neither the food industry in general nor the dairy industry has commercial equipment readily available to them but this is slowly changing. Ultrasonic equipment was traditionally designed to operate in direct contact with the material being treated (often fluid) and because equipment was never designed to process food, the basic design usually consists of a transducer to which a sonotrode is attached. The sonotrode is usually made from titanium and is used to emit the sound waves when immersed in solution. Individual units can be powerful, for example 16 kW, and commercially may be designed in a modular arrangement to operate continuously and in-line with existing infrastructure (Hielscher, 2012). This common design is manufactured by several equipment suppliers but because the energy density is greatest at the surface of the sonotrode this will gradually cause sonotrode pitting and degradation. Although sonotrodes are designed to be replaced and the amount of titanium erosion is minute, the concept of titanium erosion coming into contact with food, in particular milk-based infant formula, is a sensitive issue.

An alternative to direct contact sonication employs a noncontact approach. Several equipment manufacturers are now embracing this concept and like direct contact sonication this equipment permits modular implementation and in-line operation. These sonication cells are designed with multiple low power transducers attached to the outer surface of the metal cell eliminating the need for sonotrodes. Sound waves propagate through the metal surface and fluids are treated on the inner surface of the cell, overcoming sonotrode erosion issues and improving energy distribution. These sonication cells generate lower power densities than sonotrodes but they have become an efficient tool for initiating lactose crystallization and they have been successfully implemented industrially outside of the food industry (Prosonix, 2012). So far, ultrasonic equipment used in the treatment of fluids has been discussed but airborne sonication options also exist. These sonication units usually have flat wide surfaces and are designed to be mounted directly above the target area; air becomes the transfer medium, as illustrated in the review by Chemat *et al.* (2011). The airborne approach is particularly useful for suppressing foam that is generated during milk or whey processing and equipment may be implemented above storage silos and feed tanks, and around filling lines. Other processing equipment, including ultrasonic spray dryers and spray drying nozzles to produce small particles, exists and numerous manufacturers have used ultrasound technology to develop ultrasonic cutters designed for continuous cutting to produce uniform easy-to-package products such as cheese blocks and slices (Arnold *et al.*, 2009).

The absence of commercial processing equipment designed for the food industry and indeed dairy processors has prompted recent action by some of the world's largest dairy enterprises. In 2010, NIZO, the well-respected Dutch food research institute established an international ultrasound consortium in collaboration with the dairy industry and included the global partners of Friesland Campina, Fonterra and Tetra Pak among others. The consortium committed to developing the first in-line, self-cleaning heating equipment using ultrasound specifically for milk processing to prevent milk protein fouling and biofouling during processing (NIZO, 2010). This demand for large scale equipment compatible with industry and the recent surge of ultrasonic dairy research has the potential to prompt the development of dairy specific equipment for the near future.

6.3 Effects of Sonication on Milk Fat: Homogenization and Creaming

6.3.1 Homogenization

The homogenization effect of ultrasound is one of the most recognizable traits of the technology. Primarily driven by acoustic cavitation at low frequencies (16–100 kHz) to generate sufficient shear forces, ultrasonic homogenization will occur resulting in the formation of small, uniformly distributed and stable emulsions (Chemat *et al.*, 2011). The efficiency of ultrasonic sonication is driven by several other important factors in addition to frequency, such as power (Bosiljkov *et al.*, 2011) and the composition of the medium being sonicated. Over sonication is known to cause oil coalescence leading to an increase in droplet size (Kentish *et al.*, 2008).

The topic of high power, low frequency ultrasonic milk homogenization reporting a reduction in the size of milk fat globules has been widely covered in scientific literature (Villamiel *et al.*, 1999; Villamiel and de Jong 2000; Wu *et al.*, 2001; Bermudez-Aguirre *et al.*, 2008; Czank *et al.*, 2010; Bosiljkov *et al.*, 2011). A typical milk fat globule size distribution is shown in Figure 6.1. Sonication of milk containing 3.5% fat at a frequency of 20 kHz reduces fat globule size in response to time and changes its distribution. This becomes more evident at higher power (31 W versus 50 W) and is clearly seen by microscopy (Figure 6.2). Similar effects are observed when sonicating milk-based solutions containing up to 8% fat. Sonication also disrupts the milk fat globule membrane (MFGM) and the resulting fat globules become heavily coated by proteins. This observation is supported by the work of Bermudez-Aguirre *et al.* (2008), who reported that the MFGM was disintegrated by sonication and then associated with casein micelles. The type of protein coating on the fat globules after sonication is unknown.

High fat dairy systems respond differently to sonication and this behaviour is based on processing conditions with temperature and energy intensity the critical factors.

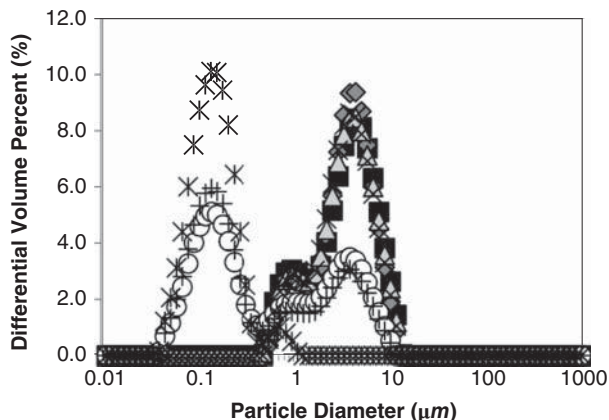

control (■), 31 W/min (◆), 31 W/10min (▲), 31 W/30min (○), 50 W/min (×), 50W/ 10min (+), 50 W/30 min (*)

Figure 6.1 Fat globule size distribution of raw milk as a function of sonication time and power at 20 kHz frequency (Chandrapala, Zisu, Kentish *et al.*, unpublished).

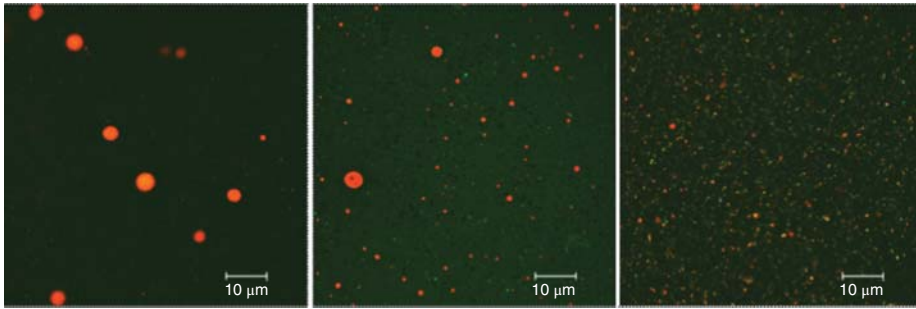

Figure 6.2 Confocal scanning laser microscopy images of raw milk (left) and that which has been sonicated for one minute (middle) and 30 minutes (right) at 50W. Fat globules appear in a lighter color (Chandrapala, Zisu, Kentish *et al.*, unpublished).

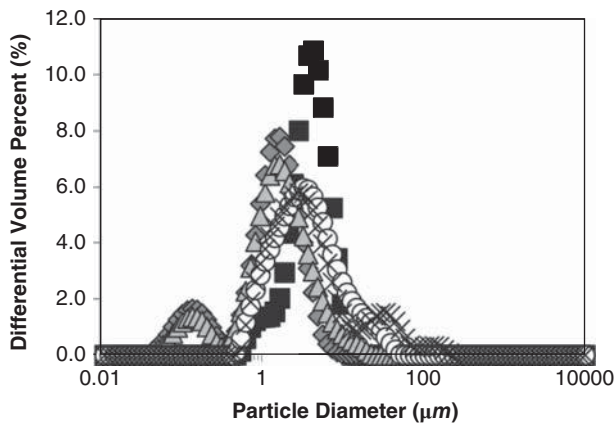

Figure 6.3 Fat globule size distribution of milk cream (43% fat) as a function of sonication time at 50 W and 20 kHz frequency ($<10^{\circ}\text{C}$) (Chandrapala, Zisu, Kentish *et al.*, unpublished).

Figure 6.3 shows the fat globule size distribution of cream containing 43% fat that was cold sonicated at 50W ($<10^{\circ}\text{C}$) and a frequency of 20 kHz for 30 seconds, 1 minute and 5 minutes. Native cream had a 5 μm main peak and a shoulder around 1 μm . Sonicating for 30 seconds led to the formation of a shoulder at approximately 100 μm as smaller fat globules coalesced to form large fat clusters. This was observed by microscopy (Figure 6.4). Sonication for longer times (1 min) starts to disrupt the large fat clusters forming smaller agglomerates until the fat globules were eventually separated and homogenized to small individual fat globules (5 min) (Figures 6.3 and 6.4).

Thermosonication (sonication at elevated temperatures) of the same cream at 50°C shows different behaviour to cream sonicated cold at the same conditions (50W and a frequency of 20 kHz). Thermosonication of high fat cream has a homogenization effect similar to that resulting from the sonication of low fat milk products without the cluster formation observed when cream was sonicated cold. Figure 6.5 shows the gradual size reduction of fat globules sonicated at 50°C for 30 seconds and 1 minute.

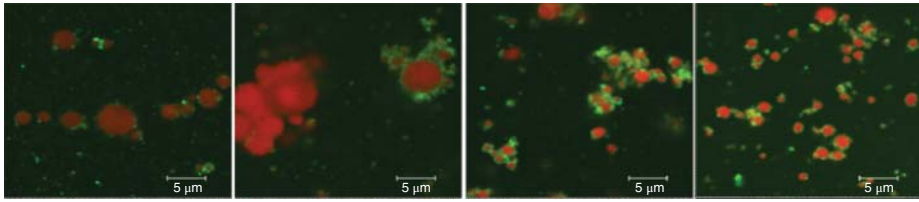

Figure 6.4 Fat globules of 43% fat milk cream as a function of sonication time at $<10^{\circ}\text{C}</math>, 50W and 20 kHz frequency. Images from the left: no sonication, 30 s, 1 min and 5 min sonication. Fat particles appear as globules (Chandrapala, Zisu, Kentish *et al.*, unpublished).$

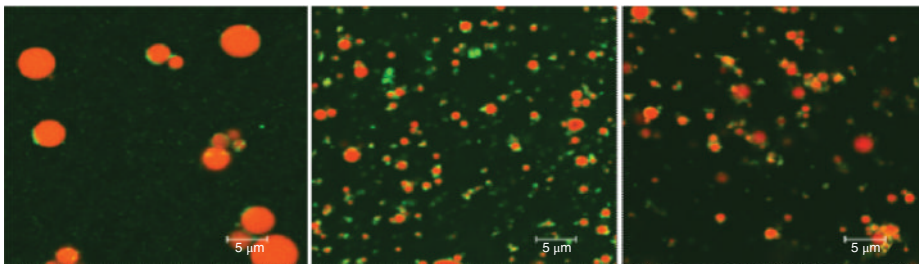

Figure 6.5 Fat globules of 43% fat milk cream as a function of sonication time at $50^{\circ}\text{C}</math>, 50W and 20 kHz frequency. Images from the left: no sonication, 30 s and 1 min. Fat particles appear as globules (Chandrapala, Zisu, Kentish *et al.*, unpublished).$

The formation of large fat clusters from the sonication of high fat milk products can increase the viscosity of the fluid phase and may even form highly viscous and slow flowing emulsions that coat the sonotrode and inner reaction chamber. If uncontrolled, the viscosity effect may cause inefficiencies in the operation of equipment and severely limit process performance. A doubling in viscosity is shown in Figure 6.6 when whole

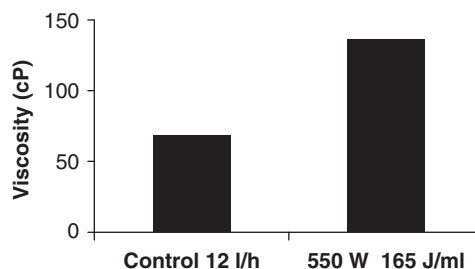

Figure 6.6 Viscosity of whole milk concentrate containing 26% fat at $200\text{ s}^{-1}</math>. Concentrate was sonicated warm at 20 kHz frequency at an applied energy density of $165\text{ J/ml}</math> with a residence time of 90 s (Zisu, Kentish, Palmer and Ashokkumar, unpublished).$$

milk concentrate containing 26% fat was sonicated warm in a continuous operation delivering 20 kHz ultrasound at an applied energy density of 165 J/ml.

6.3.2 Creaming

Continuing with the topic of milk fat globules, Juliano *et al.* (2011) used frequencies higher than those associated with conventional food processing to destabilize fat and assist creaming. Sonication at frequencies of 400 kHz and 1.6 MHz were used to generate a standing pressure wave field to separate fat globules, a technique previously used to separate canola oil emulsions (Nii *et al.*, 2009). Treating recombined milk emulsions (3.5% fat) with mean diameters of 2.7 and 9.3 μm and raw milk with an emulsion size of 4.9 μm at these high frequencies for five minutes at 35°C caused fat globule flocculation and clustering, thereby enhancing the rate of creaming. Creaming was most evident in sonicated raw milk and in the coarse recombined emulsions.

6.4 Degassing and Foam Reduction

Another well known trait of sonication is the ability to degas solutions by eliminating the gases that exist as dispersed bubbles and those dissolved in solution. Eliminating or lowering the oxygen content from milk and yoghurt during storage can reduce the risk of oxidation, improving product quality and extending shelf life. In most cases when gases become a problem in milk products it is usually the air bubbles that contribute to problems, most by affecting homogeneity. During processing, air bubbles in solutions being pumped through pipes and equipment can impair heat transfer, affecting quality and potentially safety. Burning of product may occur in areas where the air bubbles prevent fluids from contacting heated surfaces and this can become a problem in heat exchangers where the bubbles act as nuclei for protein fouling. Milk and whey products are notorious for generating foam during commercial processing and difficulties are often encountered by food manufacturers reconstituting milk powders. Eliminating gases in these circumstances will improve product yield and quality. Villamel *et al.* (2000) showed that batch sonication at 20 kHz frequency using low energy ultrasound pulses (40 kJ/l; 1 s pulse per 1 s) removed 80% of the foam in reconstituted skimmed milk. The dissolved oxygen content was also affected achieving 15% reduction after sonication at significantly greater energy intensities (240 kJ/l).

During sonication, dissolved gases and bubbles are removed by passing solutions through an ultrasonic field or foams may be broken and destroyed by airborne foam depressors. The sonication mechanisms responsible for the collapse of air bubbles are reported to be a combination of several physical and mechanical characteristics, including high acoustic pressure generating a partial vacuum on the surface of bubbles, resonance of the bubbles causing interstitial friction and bubble coalescence, acoustic streaming and violent bubble cavitation (Mason *et al.*, 2005).

A practical example of ultrasound used to eliminate foaming is shown in Figure 6.7. In this example a 20 kHz sonicator was used to treat concentrated casein solution in a continuous operation, achieving substantial foam reduction at an applied energy density of 13 J/ml. At such low energy requirements, ultrasound was used to reduce

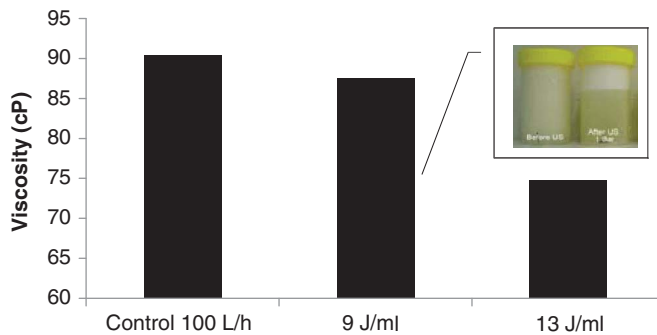

Figure 6.7 Viscosity of concentrated casein solution at 200 s^{-1} . Sonication at 20 kHz with 11 s residence time. Insert: Appearance of foam before sonication (left) and after sonication (right) (Zisu, Kentish, Palmer and Ashokkumar, unpublished).

product loss during processing and cleaning and improve yield by reducing the amount of product lost as foam. By eliminating foam, the product viscosity was reduced (Figure 6.7) improving flow rates and process efficiency.

6.5 Thermosonication to Reduce Microbial Load

The potential use of sound energy for microbial reduction is well documented but appears to have a low lethality at low and ambient temperatures, with lethality improving greatly when ultrasound is used in combination with heat. Although thermosonication has been briefly discussed (Section 6.3) in reference to physical and functional product changes, the microbiological implementations are covered in this section. Power ultrasound is usually applied at or near a frequency of 20 kHz, with inactivation efficiency varying greatly depending on the bacterial species and growth medium. Bacterial spores are far more resistant to sonication than vegetative cells and the resistance of Gram-positive and coccal cells is greater than Gram-negative and rod-shaped microbial cells (Feng *et al.*, 2008; Drakopoullou *et al.*, 2009). The microbial inactivation effects are believed to result from intracellular cavitation, which produces localized heating and physical forces sufficiently powerful to disrupt cell wall structure and function, which ultimately leads to cell lysis.

Much of the ultrasonic work showing microbial inactivation has been studied in a variety of media with only a few studies focused on milk and the energy required for microbial inactivation in these studies was high. In raw and pasteurized milk ultrasound was effective without heat against spoilage microorganisms and potential pathogens including *E. Coli*, *Pseudomonas fluorescens* and *Listeria monocytogenes* (Cameron *et al.*, 2009). In this study the efficiency of sonication occurred between 6 and 10 minutes of batch treatment at 20 kHz. *Listeria monocytogenes* and *E. Coli* were also thermosonicated in milk by others (Earnshaw *et al.*, 1995; Zenker *et al.*, 2003; Gera and Doores, 2011). Gera and Doores (2011) not only showed that pulsed sonication at 24 kHz caused mechanical damage to the bacterial cell wall and cell membrane when treated at temperatures between 30 and 35°C but that milk had a microbial protective effect, with lactose exerting the most positive effect on

bacterial survival In a separate study the synergistic effect of heat (63°C) combined with sonication (24 kHz) was used to inactivate *Listeria innocua* and reduce the mesophilic bacteria count in raw whole milk by 0.69 log after 10 minutes and 5.3 log after 30 minutes (Bermudez-Aguirre *et al.*, 2009a) resulting in an extended shelf life (Bermudez-Aguirre *et al.*, 2009b). Treating UHT milk with the same sonication parameters (63°C and 24 kHz) prevented mesophilic growth higher than 2 log during ambient and refrigerated storage for 16 days (Bermudez-Aguirre and Barbosa-Canovas, 2008). Many documented outbreaks associated with infant formula are linked to *Cronobacter sakazakii*. Thermosonication at 20 kHz and temperatures up to 50°C were used to inactivate *Cronobacter sakazakii* and reduce the microbial count in reconstituted infant formula by up to 7.04 log₁₀ units after 2.5 minutes of treatment (Adekunte *et al.*, 2010). Thermosonication was also used against *Bacillus subtilis* (Garcia *et al.*, 1989), *Staphylococcus aureus* (Ordóñez *et al.*, 1987), *Salmonella typhimurium* (Wrigley and Llorca, 1992), coliforms and total plate counts (Villamiel *et al.*, 1999) in milk.

Thermosonicated milk was used to make a soft type of fresh cheese and after 23 days of refrigerated storage the microbial counts remained low (mesophilic, 4 log; psychrophilic, 3.5 log; enterobacteria, 3 log) (Bermudez-Aguirre and Barbosa-Canovas, 2010).

There is little literature available to describe the effects of ultrasound on milk enzymes. What literature is available suggests sonication has a negligible effect when used alone (Villamiel and de Jong 2000; Cameron *et al.*, 2009) but thermosonication at temperatures ranging between 61 and 75.5°C was used effectively to inactivate alkaline phosphatase, γ -glutamyl transpeptidase and lactoperoxidase activity in milk (Villamiel and de Jong, 2000).

6.6 Ultrasound Assisted Filtration

Membrane technology is currently used in the dairy industry for a variety of applications, such as separation of milk components, concentration of protein levels for spray drying and more. One of the critical issues during filtration is the decline in permeate flux as a result of both concentration polarization and membrane fouling. Heat treatment of milk and protein solutions increases viscosity or causes gelation and this will result in excessive membrane fouling as a result of increased flow resistance due to pore blockage and cake formation (Lamminen *et al.*, 2004; Muthukumaran *et al.*, 2007; Maskooki *et al.*, 2010), which, in turn, has a detrimental influence on the permeation rate and limits the economic efficiency of the processing operation (Muthukumaran *et al.*, 2005a, 2005b; Maskooki *et al.*, 2010).

Membranes used for ultrafiltration of whey or milk are cleaned often to ensure hygienic operations, to maintain membrane performance to prevent unnecessary operational costs and to expand the lifetime of the membrane (Muthukumaran *et al.*, 2005a). The application of ultrasound has proven to be an effective approach to enhance the flux in ultrafiltration or microfiltration processes and to improve the cleaning of fouled membranes. Several studies have used ultrasound treatment to enhance the flux in membrane filtration systems (Chai *et al.*, 1999; Kobayashi *et al.*, 1999; Muthukumaran *et al.*, 2005a, 2005b, 2007). Muthukumaran *et al.* (2005a, 2005b) studied the ultrasonic cleaning of polysulfone ultrafiltration membranes fouled with dairy whey solutions. It was suggested that the ultrasonic effect was more significant

in the absence of a surfactant, but was influenced less by temperature and transmembrane pressure. They further suggested that the ultrasonic energy acts primarily by increasing the turbulence within the cleaning solution. Their experimental results in a whey ultrafiltration process revealed that ultrasound can significantly enhance the permeate flux by an enhancement factor between 1.2 and 1.7. An increase of the mass transfer coefficient within the concentration polarization layer was also observed. In another study, they extended this aspect to consider the effect of ultrasonic frequency and the use of intermittent ultrasound (Muthukumaran *et al.*, 2007). Their results showed that the use of continuous low frequency (50 kHz) ultrasound is most effective in both the fouling and cleaning cycles, whereas the application of intermittent high frequency (1 MHz) ultrasound is less effective. At higher transmembrane pressure, high frequency pulsed sonication can lead to a reduction in steady state membrane flux. This increase in fouling could result either from compaction of the protein deposits into a more densely packed cake layer or from such deposits being forced into the membrane pores under the influence of the ultrasonic field.

These experiments have shown that while the use of ultrasound in membrane ultrafiltration is generally positive, there are conditions under which it can be less effective or even have a negative effect on filtration performance. Continuous low frequency sonication generally reduces the components of the total flow resistance that are readily reversed during water flushing (Muthukumaran *et al.*, 2007). This includes the mass transfer resistance arising from both concentration polarization and labile protein deposits that are readily removed. The use of ultrasound in both mechanical and chemical cleaning processes for fouled membranes resulted in a much higher flux recovery, especially in low frequency and high power conditions. It can be expected that the increased permeability may be affected by the physical process caused by ultrasound. Acoustic cavitation leads to mechanical agitation, microstreaming and the generation of shear forces. Due to these physical processes, which may occur on the surface of the fouled membrane, on the solid material and in the vicinity of the pores, dislodging of particles that block the pores can be expected. This may also be accompanied by the breakdown of these particles (Muthukumaran *et al.*, 2007; Caia *et al.*, 2009; Popovic *et al.*, 2010). Furthermore, it is recommended that ultrasound should be used sparingly despite its efficiency in enhancing the permeation of fouled membranes due to potentially large energy costs and possible membrane damage (Juang and Lin, 2004).

Others studies have explored the cleaning effects of ultrasound and alkaline solution in the form of EDTA, individually and together on spiral wound microfiltration and ultrafiltration membranes (Maskooki *et al.*, 2008, 2010). The overall results showed that the cleaning efficiency of each treatment, including different frequencies of ultrasound and alkaline solutions of EDTA individually, was relatively low. However, the cleaning efficiency of ultrasound and EDTA improved when applied together. The hydrodynamic resistance of cleaned membranes with 1 and 3 mM EDTA was $276.24 \times 10^{11} \text{ 1 m}^{-1}$ and $238.1 \times 10^{11} \text{ 1 m}^{-1}$, respectively, and when combined with ultrasound the hydrodynamic resistance improved to $118.65 \times 10^{11} \text{ 1 m}^{-1}$ and $97.46 \times 10^{11} \text{ 1 m}^{-1}$, respectively. Simultaneous use of ultrasound and EDTA suggested that a synergistic sonochemical effect was occurring.

Muthukumaran *et al.* (2007) also found that ultrasound improves the flux by increasing the mass transfer coefficient within the concentration polarization layer and by providing a less compressible or 'looser' fouling cake. Similarly, it has been reported that ultrasound has potential implications for cleaning materials because of the physical effects generated by cavitation as ultrasonic waves generate vigorous mixing of the

entire system (Muthukumaran *et al.*, 2005a, 2005b). At a macroscopic scale, strong convective currents known as acoustic streaming increase turbulence. At a microscopic scale, the physical effects associated with the implosive collapse of cavitation bubbles help to generate micromixing in a liquid. The violent asymmetric collapse of these bubbles near a solid surface leads to the formation of liquid microjets, which enhances the cleaning process. It is believed that the ultrasonic cleaning effect occurs predominantly through acoustic streaming and increased turbulence rather than cavitation (Muthukumaran *et al.*, 2005a, 2005b); however, the influence of acoustic cavitation cannot be excluded. Lamminen *et al.* (2004) found increases in cleaned flux ratio as the power intensity of the system increased. This increase was attributed to an increase in the number of cavitation bubbles in the system and an increase in acoustic energy by the cavitation bubbles. In contrast, Caia *et al.* (2009) stated that low frequency and high power ultrasound is more effective in enhancing flux and improving flux recovery. Although higher frequencies may generate a greater number of cavitation bubbles, the bubbles are smaller in size and collapse less energetically; thus, they may not be capable of detaching particles from the cake layer as readily as lower frequencies (Juang and Lin, 2004; Muthukumaran *et al.*, 2007; Maskooki *et al.*, 2010; Popovic *et al.*, 2010). Even though most research has indicated that the flux enhancement with ultrasound occurs principally through increased acoustic streaming or turbulence, some researchers have found that ultrasound can also change the quaternary and/or tertiary structure of proteins. A study by Tenga *et al.* (2006) stated that low power ultrasound is likely to cause a temporarily change to protein structure by shear force instead of the aggregation of protein molecules.

6.7 Sonocrystallization of Lactose from Whey

Lactose is the major carbohydrate found in milk (4.4–5.2%) and has been recovered from whey, the liquid by-product of cheese making for many years for environmental and economic reasons. Lactose must first be crystallized before it can be dried and a commercial process can take up to 20 hours to ultimately yield up to 80% crystallized lactose (GEA NIRO, 2010). Lactose may be crystallized in whey or as pure lactose when separated from the whey. Crystallization of lactose consists of three phases; the first is supersaturation, which is followed by nucleation (appearance of crystals) and crystal growth. Conventional lactose crystallization in the dairy industry involves large scale batch crystallization with controlled temperature and mixing. During the crystallization process it is paramount to control crystal purity, shape and distribution but traditional paddle-type mixers are known to create nonuniform mixing causing random fluctuations in supersaturation, resulting in uneven and irregular crystal growth and size and, sometimes, the nuclei and crystals forming agglomerates (Li *et al.*, 2006; Dhumal *et al.*, 2008). The overall crystallization process is slow and lactose recovery can be improved. Sonication is known to decrease crystallization induction times and increase the rate of nucleation in a number of applications, including the crystallization of fats (Ueno *et al.*, 2003) and the manufacture of pharmaceutical lactose (Prosonix, 2012) in a process known as sonocrystallization. Sonocrystallization is power ultrasound applied to aid and control crystallization and is most effective when sound energy is delivered at the nucleation phase (Bund and Pandit, 2007).

In a typical reaction, crystallization takes place on the surface of existing crystals and these crystals act as nucleation sites. Sonication generates acoustic-streaming and

cavitation, resulting in shockwaves and nuclei formation that helps to initiate crystallization and control the crystallization process. According to Hem (1967), evaporation from the internal surfaces of bubbles results in cooling, which generates high internal supersaturation, and bubbles act as nucleation sites. Shockwaves cause further agitation and bubble disruption, increasing the number of nuclei available for nucleation (Guo *et al.*, 2005), and the greater number of nuclei reduces crystal size, improves uniformity and increases crystallization rate (Hem, 1967).

Dhumal *et al.* (2008) used sonocrystallization at 20 kHz frequency to engineer lactose crystals of desired size, shape, surface and distribution. Yield in a 30% (w/w) aqueous lactose solution was improved to 83% after sonocrystallization for five minutes compared to 44% yield after stirring for 20 hours and resulted in crystals with uniform shape and distribution. Similar observations were made when a 40% lactose solution was sonicated at ambient temperature (about 22°C) for the shorter time of one minute before stirring at 13°C (Table 6.1). Lactose solutions stirred without sonication began to crystallize after 180 minutes whereas sonicated solutions had crystallized by 22% at the equivalent time. In addition to faster nucleation rate, the sonocrystallized solution yielded more lactose crystals than the stirred solution after 22 hours of crystallization. However, when rapid nucleation was generated by shock cooling prior to stirring, the final yield of crystallized lactose was identical for stirred and sonicated solutions.

Concentrated whey solutions containing 55% solids and 25% lactose were sonicated continuously at room temperature (about 22°C) in a noncontact approach delivering a low applied energy density that varied between 3 and 16 J/ml. Whey solutions were viewed under a light microscope fitted with a blue light filter at 10× magnification immediately after sonication (T0) and after 60 minutes (T60). The control solution was passed through the ultrasonic rig at the appropriate flow rate without sonication (T0). Crystallization occurred at about 22°C without stirring. Images for sonocrystallization at an applied energy density of 8 J/ml are shown in Figure 6.8. The least number of lactose crystals was observed in the control solutions at T0. A greater number of lactose crystals were present in whey solutions immediately after

Table 6.1 Crystallization of 40% aqueous lactose solution without shock cooling (500 ml); sonication of lactose solution at 22°C, 31 W for one minute and 20 kHz frequency; stirring at 13°C and 160 rpm (Sciberras and Zisu, unpublished)

Time	Crystallization (%)*	
	Stirring	Sonication and Stirring
0 min	0	0
90 min	0	6.9
180 min	2.2	22.2
22 h	52.6	60.9

*% Crystallization = $(S1 - S2) \times 9500 \times 100 / L \times TS \times (95 - S2)$
(GEA NIRO, 2010)

S1 = % sugar of starting concentrate; S2 = % sugar of the crystallized concentrate; L = % lactose; TS = Total solids.

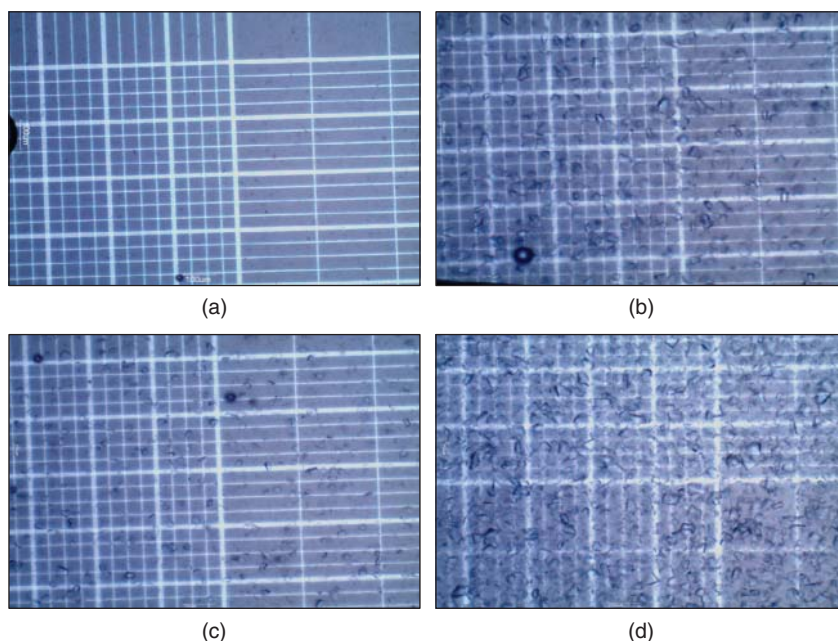

Figure 6.8 Whey solutions viewed under a light microscope fitted with a blue light filter at 10 \times magnification immediately after treatment at a flow rate of 750 ml/min. A. 100 W 750 ml/min (8 J/ml) T0; B. T60 min; C. Control 750 ml/min T0; D. T60 min (Zisu, unpublished).

sonication (T0) at an applied energy density of 8 J/ml. Although the control solutions showed an unmistakable increase in the number of lactose crystals after 60 minutes of crystallization, the number of crystals observed in sonicated solutions was greater. There was little difference between the two treatments after 24 hours. Energy densities as low as 3 J/ml also improved lactose crystallization significantly.

Each system, whether it was the aqueous lactose solution or the concentrated whey solutions, showed a slightly different response to ultrasound affecting crystallization (Castro and Priego-Capote, 2007), but regardless of the medium, ultrasound prior to stirring accelerated the crystallization process, increased the size of lactose crystals, reduced the size distribution and improved yield (crystallization yield is time dependent). Nucleation rate was greater when the lactose concentration was greater.

6.8 Solubility of Rehydrated Powders

In food manufacturing, the rapid dissolution of powders into solution is desirable to reduce processing times, improve productivity and produce good quality products (Fang *et al.*, 2011; Gaiani *et al.*, 2011). A technique such as sonication, capable of improving the solubility of reconstituted powders, can reduce hydration times and has potential industry applications. It has been documented that high power sonication disrupts insoluble aggregates in reconstituted powders (Ashokkumar *et al.*, 2010; Zisu

et al., 2011). Sonicating reconstituted whey protein concentrate (WPC) at 20 kHz also reduced the turbidity of solutions. This was strongly linked to particle size reduction caused by high intensity low frequency sonication. Similar reductions in aggregate size for whey proteins and caseins have been reported by Onwulata *et al.* (2002). Neither solution clarity nor particle size reduction was reported when sonicating at higher frequencies where the physical forces of acoustic cavitation are weaker (Zisu *et al.*, 2011). Possibly related to the reduction in particle size, the solubility of reconstituted WPC (Kresic *et al.*, 2008) and whey protein isolate (Jambrak *et al.*, 2008) solutions was improved following sonication at 20 kHz.

Micellar casein and milk protein concentrate powders are less soluble at ambient temperature in comparison to whey or milk powders requiring high temperatures to achieve adequate solubility during reconstitution (Zwijgers, 1992; Havea, 2006; Fang *et al.*, 2011). In a commercial environment this causes manufacturing delays when making secondary dairy products such as cheese, yoghurts and beverages (Anema *et al.*, 2006) and if powders are poorly dissolved there is a risk that product defects may occur. High power ultrasound has been used to achieve rapid solubility during reconstitution at ambient temperature from an initial solubility of about 70% to more than 90% in the first few minutes of treatment with significant improvement during the first minute of sonication (Figure 6.9). There was strong correlation between the particle size of reconstituted powders and solubility in response to sonication showing gradual reduction with longer treatment times. Milk powders contain large vacuoles on the surfaces of the powder particles formed during the spray drying process with the bulk of the protein found on the outer shell (McKenna *et al.*, 1999). It has been documented that during powder rehydration, agglomerates are disrupted into primary particles together with the simultaneous release of material from the powder particles into the surrounding aqueous phase (Mimouni *et al.*, 2009). The latter is considered a rate-limiting step. Ultrasonic degradation of the external particle layer would explain the size reduction, which helps the powder to dissolve by acoustic cavitation initiating the release of material to the aqueous phase at a faster rate. Rehydration of powders by stirring alone could only achieve about 85% solubility after four hours.

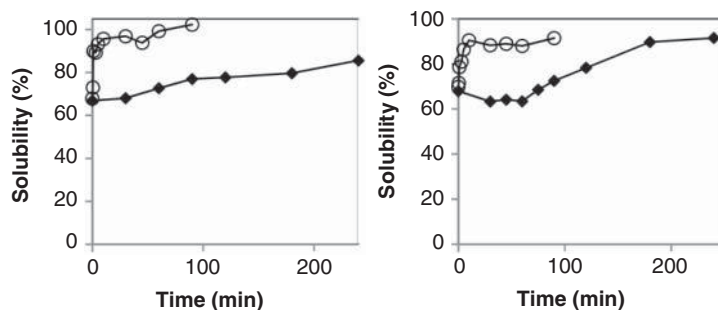

Figure 6.9 Solubility of stirred (◆) and sonicated (○) milk protein concentrate (left) and micellar casein (right) powders as a function of time at 22°C (Chandrapala, Zisu, Kentish *et al.*, unpublished).

6.9 Effects of sonication on Milk and Casein Systems

6.9.1 Effects of Sonication on the Casein Micelle

Of the work to date, a considerable focus has been given to understanding the effects of ultrasound on bulk physical and functional properties of casein-containing systems and their respective secondary dairy products. It has been shown that sonication of both casein-rich milk protein concentrate retentate and calcium caseinate can significantly reduce solution viscosity (Zisu *et al.*, 2010). These effects were attributed to the physical disruption of casein–casein and/or casein–whey protein interactions but no evidence was presented to support this hypothesis. The effect of ultrasonication on milk gels has also been reported (Vercet *et al.*, 2002; Riener *et al.*, 2009b; Nguyen and Anema, 2010; Zisu *et al.*, 2011; Chandrapala *et al.*, 2012a). Acid gel firmness (G') was altered when skimmed milk was ultrasonicated prior to acidification; however, the effect was attributed largely to denaturation of whey protein caused simply by temperature increases (up to 95°C) during sonication, which was performed without temperature control (Nguyen and Anema, 2010). The simultaneous application of heat and ultrasound (manothermosonication) improved the strength of yoghurt gels compared to those made from untreated milk but the nature of this observation was unidentified (Vercet *et al.*, 2002). Other researchers also found that thermosonication improved the rheological properties of yoghurts and presented data showing a significant reduction in the size of fat globules in sonicated milk, which may contribute to the behaviour of yoghurt gels (Riener *et al.*, 2009b, 2010).

Although casein micelles are considered relatively stable, their composition and size responds to alterations in pH and temperature (Martin *et al.*, 2007; Tsioulpas *et al.*, 2007; Dalglish, 2011). It is possible that the localized high temperatures and shear forces created by ultrasonication could physically alter the casein micelles or their interactions with other milk components. A study by Madadlou *et al.* (2009b) found that the average size of re-assembled casein micelles could be reduced by exposure to ultrasound (35 kHz) for six hours provided the pH was above eight. The magnitude in size reduction of the re-assembled micelle diameter was found to be greater at a higher pH, highlighting a sono-dissociation interaction between pH and sonication power. The authors further suggest that increased cavitation efficiency with increasing sonication power, which enhances shear forces, is the most likely reason for sono-disruption of re-assembled casein micelles. However, it may be that this interaction is also influenced by the looser casein micelle structure at higher pH, which improves the efficiency of ultrasonic disruption. In a separate study involving true casein micelles, a reduction in particle size was observed in milk after ultrasonication and this was reported to be a reduction in the casein micelles themselves (Nguyen and Anema, 2010).

A more thorough study investigating possible alterations to the size of casein micelles resulting from the application of high-intensity ultrasound was later conducted (Chandrapala *et al.*, 2012a). In order to investigate the effect of ultrasound on native casein micelles without interference from fat globules, experiments were performed on fresh pasteurized skimmed milk after micelle dissociation and on re-suspended pellets of casein micelles obtained by centrifugation. This study showed decreases in the average particle size and turbidity in fresh skimmed milk over 60

minutes of sonication (Figures 6.10A and 6.10B). A reduction in the size of the fat globules was clearly evident as a function of sonication time in the particle size distribution of the EDTA treated skimmed milk samples (Figure 6.10C). The average size of the peak corresponding to the fat globules decreased from about 230 nm to 175 nm after 60 minutes of sonication (Figure 6.10C). The turbidity of these samples also decreased as a function of sonication (Figure 6.10D). While these results show that a decrease in fat globule size is, at least in part, responsible for the reduction in particle size, the possibility of a change in casein micelle size cannot be eliminated completely. To further investigate whether or not casein micelles are affected by sonication, casein micelles were isolated from the other milk components by centrifugation (Figure 6.10F). Both the turbidity and average particle size remained unchanged over 60 minutes of ultrasonication, providing strong evidence that the size of the casein micelles remained unaltered by exposure to ultrasound. Consistent with the data obtained so far, the viscosity of fresh skimmed milk (with whey protein) was seen to decrease slightly over the first few minutes of sonication, while the viscosity of re-suspended pellets (without soluble whey protein) was seen to remain unchanged (Figure 6.10E). Furthermore, no measurable compositional changes such as pH and soluble calcium were observed. Results presented in this casein micelle study suggested that ultrasonication does not affect casein micelle size or composition or permanently affect the mineral balance in fresh skimmed milk. Results also showed that controlled application of ultrasonic energy can help disrupt large casein and whey protein aggregates, thereby influencing macroscopic properties such as viscosity without inducing changes to the casein micelles or mineral balance. In particular, it appears that ultrasound can help reverse protein aggregation caused by prior processing without affecting the native state of the milk proteins or mineral equilibrium and may have advantages across a range of industry applications.

6.9.2 Applied Ultrasound to Control the Viscosity of Milk Concentrates

Milk is often concentrated commercially to high solids in preparation for spray drying (typically 40–55%) using falling film evaporators as the main form of water removal (Knipschildt and Andersen, 1997) causing product viscosity to increase in a nonlinear manner (Bienvenue *et al.*, 2003). In addition to increasing the solids content, the viscosity of concentrated milk increases with time – in a process known as ‘age thickening’ – by structural build-up through weak interactions between casein micelles that can be disrupted by mechanical shear (Snoeren *et al.*, 1982). Although shear dependent, the recommended operating viscosity of falling film evaporators and feed to spray dryers to prevent excessive fouling is below 100 mPa s (Westergaard, 2004). Under these circumstances the viscosity becomes a limiting factor and controlling product viscosity and preventing the onset of age thickening becomes critical.

Zisu *et al.* (2013) used high intensity ultrasound operating at 20 kHz frequency to reduce the viscosity and to control the rate of age thickening of concentrated skimmed milk. Skimmed milk concentrate (SMC) was sonicated to lower viscosity through a physical process of acoustic cavitation as described in the preceding section. Batch sonication for one minute at 40–80 W, and continuous treatment delivering an applied energy density of 4–7 J/ml, reduced the viscosity of medium heat SMC containing 50–60% solids by approximately 10%. The effect was greatly improved

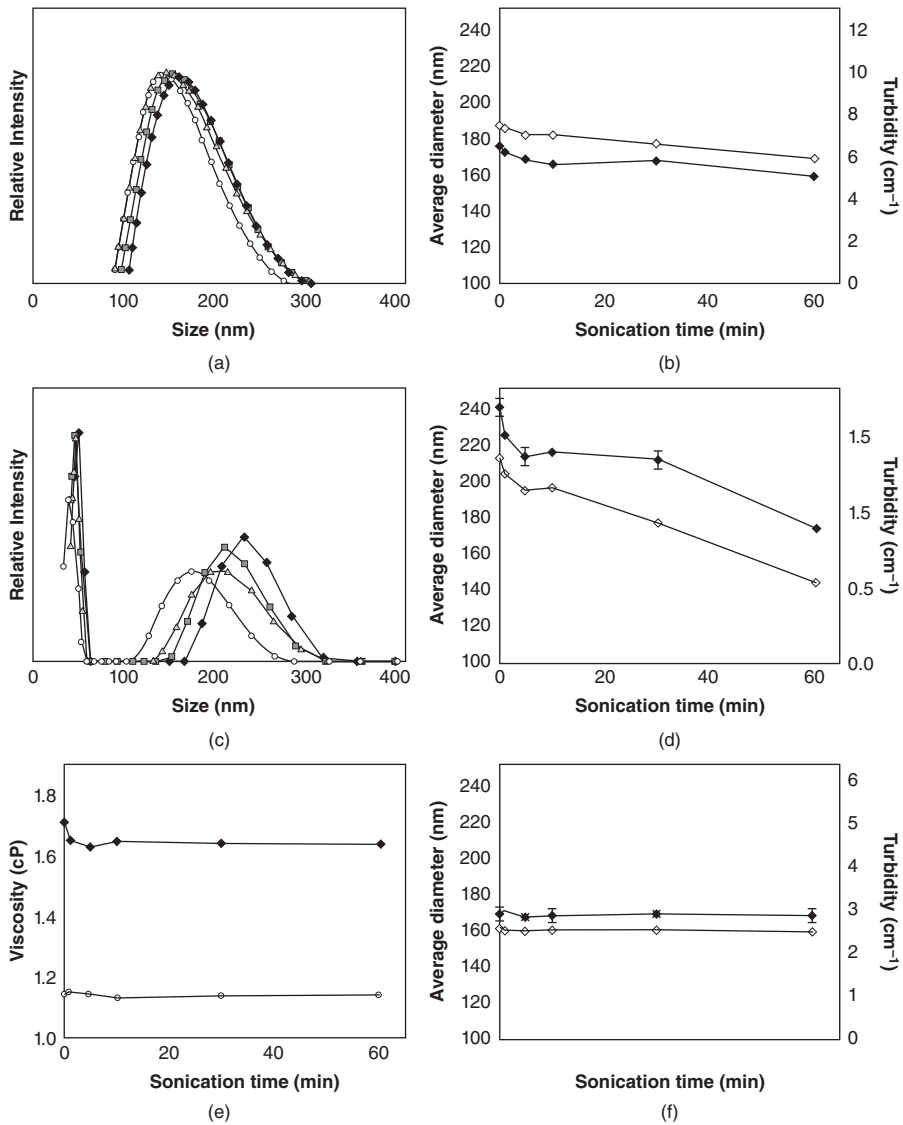

Figure 6.10 Intensity-weighted particle size distribution of fresh skimmed milk (A) and fresh skimmed milk with micelles dissociated by EDTA (C) as a function of sonication time: 0 min (◆ - solid line); 1 min (■ - long-dashed line); 30 min (▲ - mixed-dashed line); 60 min (○ - mixed-dashed line). Intensity-weighted average particle size (◆) and turbidity (◇) of fresh skimmed milk (B), fresh skimmed milk with micelles dissociated by EDTA (D), and re-suspended pellets from centrifuged fresh skimmed milk (F) as a function of sonication time. Viscosity of fresh skimmed milk (◆) and resuspended pellets from centrifuged fresh skimmed milk (○) as a function of sonication time (E). Error bars are the standard deviation of triplicate measurements of the same sample (*Source*: reproduced from Chandrapala *et al.*, 2012a).

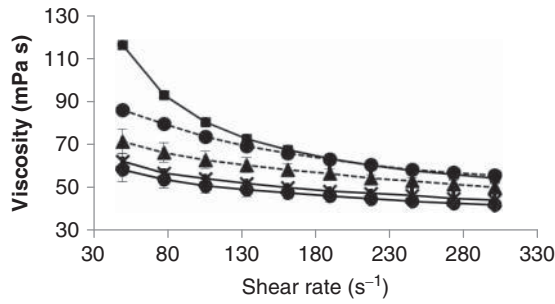

Figure 6.11 Viscosity of 55% solids skimmed milk concentrate (SMC) at 50°C immediately after evaporation (●) and after ageing for 20–30 min (×) and 40–50 min (■) while circulating at a flow rate of 2000 ml/min. SMC was aged further for 65–75 min (-▲) and 85 min (-●) while sonicated continuously at 130–230 W to achieve a residence time of 10 s delivering an applied energy density of 4–7 J/ml (Zisu, *et al.*, 2013. Reproduced with permission of Elsevier).

sonication efficiency (to >17%) when sonicating high viscosity solutions by raising the solids content or by allowing concentrates to age. Sonication also changed the shear thinning behaviour at shear rates below 150 s⁻¹.

Although ultrasound lowered the viscosity of SMC, the treatment could only delay the rate of age thickening once the ageing process was established in an evaporator (Figure 6.11). The viscosity of SMC increased rapidly between 40 and 50 minutes of recirculation in an evaporator exceeding 100 mPa s at low shear rates. When the ultrasonic unit was activated at 130–230 W and circulation had occurred for 75 minutes, including 10 minutes of sonication, the viscosity reduced significantly and the apparent viscosity was maintained below 100 mPa s. After 85 minutes of ageing, the viscosity of sonicated SMC was comparable to the unsonicated material aged for only 50 minutes. It was only when ultrasound was activated during the concentration process that sonication prevented the viscosity of SMC from increasing rapidly (Figure 6.12). Potential

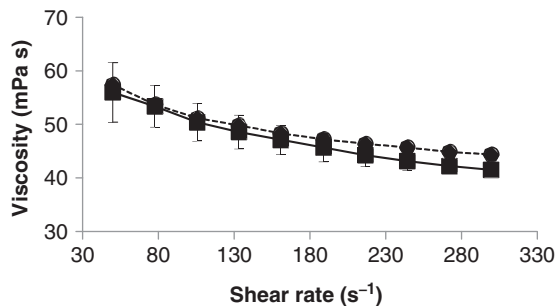

Figure 6.12 Viscosity of 55% solids skimmed milk concentrate (SMC) at 50°C immediately after evaporation (■) and after ageing for 40 min while circulating at a flow rate of 2000 ml/min and continuously sonicating (US) at 130–230 W to achieve a residence time of 10 s delivering an applied energy density of 4–7 J/ml (-●) (Zisu, *et al.*, 2013. Reproduced with permission of Elsevier).

industrial application exist by using high power low frequency ultrasound to lowering the viscosity of concentrated milk in preparation for spray drying and to control the rate of age thickening. Other milk and casein based systems to respond to sonication and show viscosity reduction include milk protein concentrate (18% solids) and calcium caseinate (24% solids) (Zisu *et al.*, 2010).

6.10 Effects of Sonication on the Physical and Functional Properties of Whey Proteins

6.10.1 Gelation and Viscosity

Controlling the viscosity of dairy streams with ultrasound is one of the most promising applications to have recently emerged. We have already seen that ultrasound can be used to lower the viscosity of concentrated milks in preparation for drying and when used correctly the technology can control the rate of age thickening. In addition to the concentrated milk, high intensity, low frequency ultrasound has been used to lower the viscosity of various other dairy streams.

A 1 kW ultrasonic unit delivering an applied energy density between 60 and 240 J/ml was used to lower the viscosity of whey protein retentate concentrate containing 33% solids (81.5% protein) by up to 10% in a continuous flow operation (Zisu *et al.*, 2010). The viscosity lowering effect showed strong correlation to particle size reduction. When a more powerful 4 kW unit was used to deliver 34–258 J/ml of energy at faster flow rates, the viscosity was reduced by a maximum of 33%.

Concentration was also shown to have an effect. When sonicating whey protein retentate containing 54% solids, the viscosity was lowered by more than 40%. On the contrary, others have shown a small increase in the viscosity of reconstituted WPC and reconstituted whey protein isolate after batch sonication for 15 minutes at a frequency of 20 kHz (Jambrak *et al.*, 2008; Kresic *et al.*, 2008), but it has been shown that excessive power delivery during batch sonication at 20 kHz in a laboratory scale system for times exceeding 10 minutes causes viscosity to increase (Ashokkumar *et al.*, 2009a). The viscosity was lowered if batch sonication was below 10 minutes. The applied energy density during continuous sonication is unlikely to reach that of batch sonication for ≥ 10 minutes.

Sonication also influences the functional properties of whey proteins with some researchers manipulating the solubility and foaming properties of reconstituted whey protein solutions by batch sonication at 20 kHz in laboratory studies (Jambrak *et al.*, 2008; Kresic *et al.*, 2008) and others targeting gelation to reduce gelling time, improve the firmness of whey protein gels and reduce syneresis (Zisu *et al.*, 2011). Gelation studies were also advanced at the pilot scale level using continuous ultrasound to treat whey protein retentate containing 33% solids (Zisu *et al.*, 2010). Gel strength of sonicated whey protein retentate improved by more than 25% (Figure 6.13a). This effect was maintained after spray drying and reconstitution with the gels made from whey powder that was sonicated prior to drying exhibiting superior firmness by more than 25% (Figure 6.13b). It is believed that the increased surface area of the smaller particles created by acoustic cavitation improved protein association during gelling to create more compact and tighter interconnected structures (Figure 6.14). Madadlou *et al.* (2009a) also reported similar behaviour in acid gelled batch sonicated casein solutions.

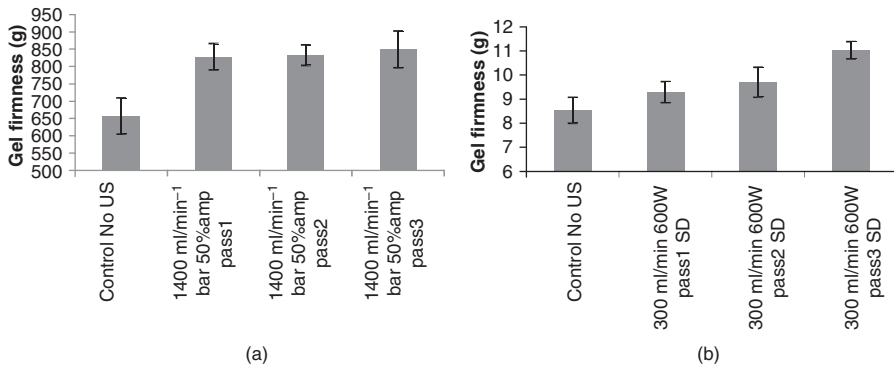

Figure 6.13 Gel strength of whey protein retentate (33% solids) with or without sonication at 20 kHz using a 4 kW unit. (a) Retentate was gelled at 80°C for 20 min. (b) Gel strength of spray dried retentate reconstituted to 15% (w/w) solids gelled at 80°C for 20 min. Whey protein retentate was sonicated at 20 kHz before spray drying (Zisu, *et al.*, 2013. Reproduced with permission of Elsevier).

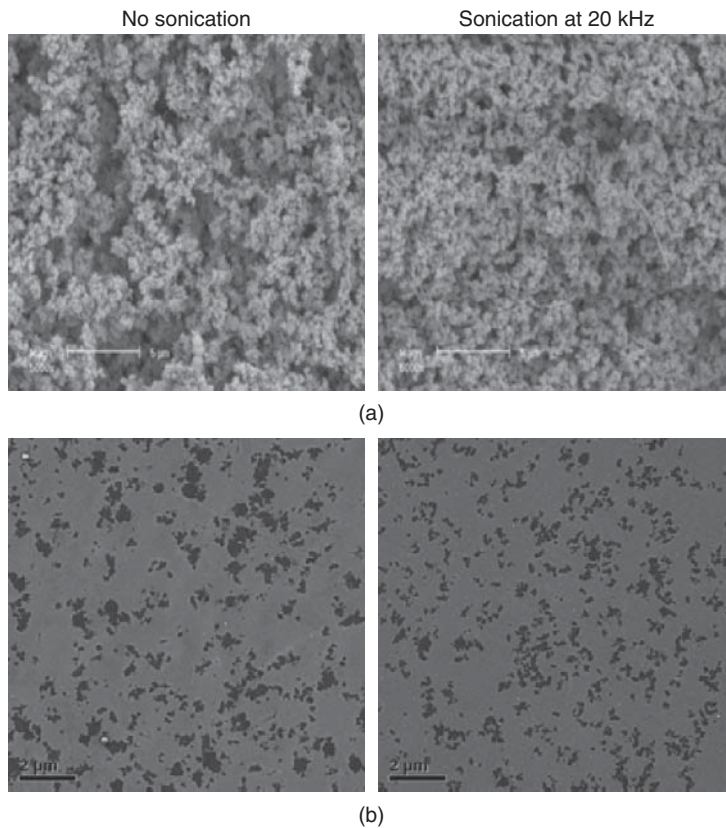

Figure 6.14 Protein networks of whey protein retentate (33% solids). (a) Scanning electron microscopy and (b) transmission electron microscopy images without sonication and after sonication at 20 kHz (Zisu, *et al.*, 2010. Reproduced with permission of Elsevier).

6.10.2 Understanding Whey Protein Changes Induced by Ultrasound

It has previously been indicated that high power ultrasound delivers predominantly physical effects through cavitation as the liquid medium is subjected to extreme shear forces, with turbulence, microstreaming and heat playing a role. Additionally, highly reactive radicals are generated and although these are not expected to play a major role when low frequency sonication (about 20–100 kHz) is used in short bursts, the possible chemical effects resulting from sonication were investigated. Reconstituted whey protein concentrate (WPC) solutions were sonicated over a range of frequencies from 20 kHz to 1 MHz (Ashokkumar *et al.*, 2008). WPC solutions sonicated at 20 kHz showed significant viscosity reduction, whereas those sonicated at higher frequencies did not show any change in viscosity. Since higher frequencies generate more radicals than low frequencies, the authors attributed the viscosity reduction to the physical forces generated during acoustic cavitation (Ashokkumar *et al.*, 2009b). Similarly, Kresic *et al.* (2008) found that low frequency ultrasound changed the flow behaviour of whey protein concentrate and whey protein isolate solutions; however, they attributed their observations to altered protein structure, whereby that the hydrophilic parts of amino acids opened towards the surrounding aqueous phase leading to increased binding of water molecules. Due to a lack of definitive conclusions, a more descriptive study exploring the changes to protein structure in reconstituted WPC solutions was conducted by Chandrapala and coworkers (Chandrapala *et al.*, 2011). Although some minor changes were monitored after extensive periods of sonication, this study showed that no significant protein structural changes occurred after low frequency sonication (20 kHz) for up to 60 minutes. Other researchers showed that sonication can alter the functional properties of pure bovine serum albumin through the formation of an ultrasonically induced state that differs from a thermally, mechanically or solvent induced state (Gulseren *et al.*, 2007). Further studies on the effects of sonication on pure whey proteins were reported by others where it was found that minor changes induced by sonication were dependent on the type and purity of the protein. Similar to the results exploring the effects of sonication on the more complex WPC, the changes observed in pure protein solutions were not identified when the same proteins were sonicated as a mixture, as would be encountered in a typical commercial environment (Chandrapala *et al.*, 2012b).

6.10.3 Heat Stability of Whey Proteins

The thermal stability of whey proteins during heating is a major continuing processing issue. In a dairy factory, whey protein solutions are subjected to heat when processed alone or when used as ingredients in the manufacture of value added products with important functional and nutritional properties (Lucena *et al.*, 2006). Irreversible whey protein denaturation occurs at temperatures exceeding 65°C, which, in turn, leads to protein aggregation through both hydrophobic interactions and the formation of intermolecular disulfide bonds (Wang *et al.*, 2006). This can result in excessive thickening, fouling or gelling during processing and later on storage of the dairy product (Morr and Richter, 1999). Ashokkumar *et al.* (2009b) used a combination of heat and high power ultrasound to address this issue. Whey protein solutions (4–15% w/w protein) were partially denatured by heating at temperatures of 80°C or greater

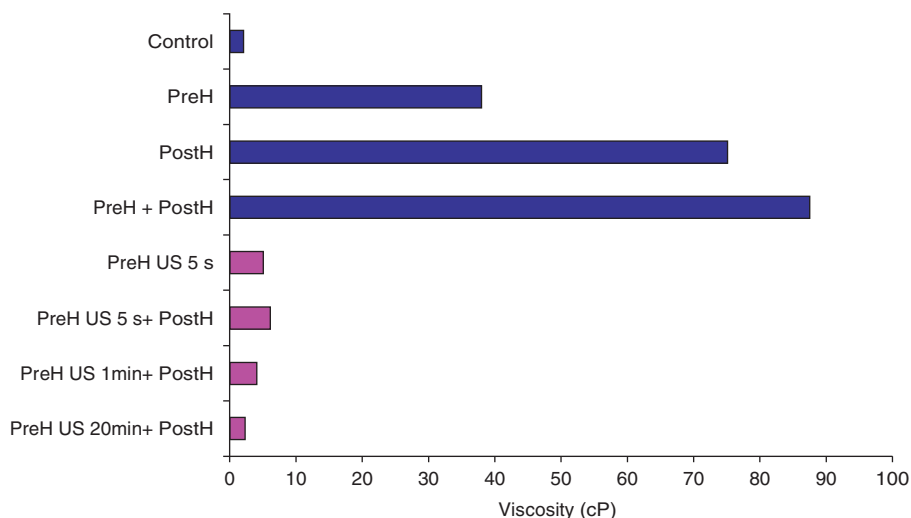

Figure 6.15 The effects on solution viscosity for a 6.4% (w/w) protein solution reconstituted from whey protein concentrate and sonicated (US) with a 20 kHz horn at a calorimetric power of 31 W in a batch mode. The darker colour represents results without sonication, while the lighter colour is for sonicated solutions (PreH = preheat; PostH = post heat) (Ashokkumar *et al.*, 2009b. Reproduced with permission of Elsevier).

followed by sonication at a frequency of 20 kHz. Referred to as preheating, the partial denaturation step caused aggregation of whey proteins as indicated by viscosity results (Figure 6.15), which was confirmed by particle size analysis. Highly viscous aggregated whey protein solutions were then sheared by sonication for as short as five seconds and by using the physical forces of cavitation to break aggregates apart they produced free flowing solutions. The resulting whey protein solutions were inert to further heating (referred to as post-heating) preventing re-aggregation and maintaining a low viscosity that was comparable to the starting material. A similar approach was adopted in a subsequent study using whey protein isolate (Gordon and Pilosof, 2010). This has potential commercial applications by minimizing the amount of whey protein fouling that occurs during thermal processing to improve process efficiency.

Ashokkumar *et al.* (2009b) also showed that the heat stability effect was maintained after freeze drying and reconstitution. The concept was taken further and spray dried, heat stable, whey protein powders were produced at the pilot scale using larger ultrasonic reactors (Figure 6.16) (Zisu *et al.*, 2010). Partially denatured whey protein solutions were made using a continuous heating and sonication treatment delivering an applied energy density of 210 J/ml before spray drying and reconstitution to 12.5% protein to produce whey solutions that were inert to secondary heating at 80°C for 30 minutes. Heat stable whey protein powders may have potential applications in UHT-treated products such as infant formula. A detailed description of the mechanisms involved during sonication and heating was still lacking and a more thorough study was conducted using reconstituted WPC (Chandrapala, J. *et al.*, unpublished). Since protein functionality is generally dependent on hydrophobic, electrostatic and steric interactions, it is possible that protein functional groups such as free thiols (which are affected by heat) are responsible for inter-particle interactions. Patrick

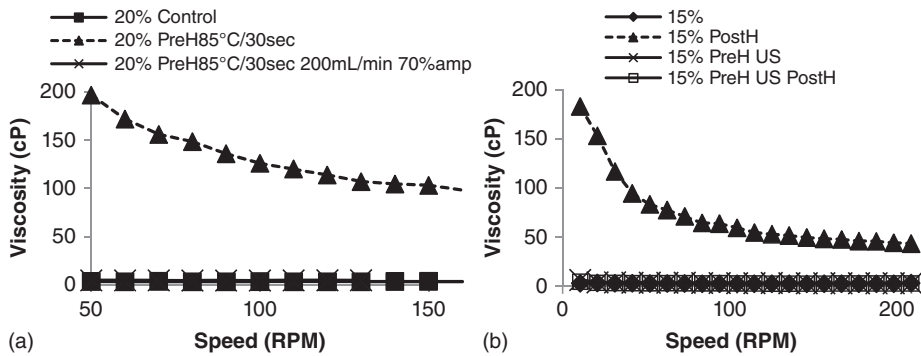

Figure 6.16 Viscosity of whey protein retentate (10% protein). (a) Retentate was preheated (preH) at 85°C for 30 s and sonicated at 20 kHz to achieve a residence time of 1.3 min and applied energy density of 210 J/mL. (b) Viscosity of spray dried whey powder reconstituted to 12.5% protein post heated (postH) at 80°C for 30 min (Zisu, *et al.*, 2010. Reproduced with permission of Elsevier).

and Swaisgood (1976) stated that the sulfhydryl (SH) groups and disulfide (S–S) bonds influence the functional properties of food proteins and play an important role in the formation of relatively rigid structures such as protein gels. Other possibilities to consider include sonication-induced changes to the particle charge that may lower the affinity of inter-particle electrostatic interactions. The number and the size of the hydrophobic sites on the protein surface usually dictates the strength of the hydrophobic bonding in a protein solution under different conditions (Kato *et al.*, 1983; Cardamone and Puri, 1992), so hydrophobic interactions cannot be ruled out as they contribute greatly to the formation of protein-protein aggregates.

Figure 6.17a shows the reactive thiol group content measured in 5% whey protein solutions after heating and sonication. Preheating at 80°C for one minute increased the thiol content by exposing and denaturing native –SH groups and is consistent with the results of other workers (Patrick and Swaisgood, 1976; Taylor and Richardson, 1980a; Hashizume and Sato, 1988). Sonication at 20 kHz for one minute did not

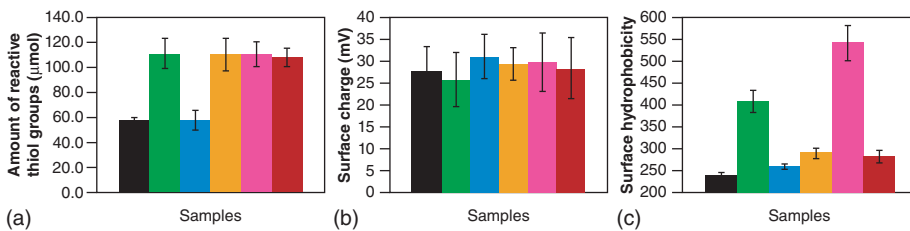

Figure 6.17 Reactive thiols (a), surface charge (b) and surface hydrophobicity (c) of proteins in heat treated and sonicated 5% (w/w) reconstituted WPC solutions. Bars from left respectively: native, preheat, sonicated, preheat + sonicated, preheat + post heat, preheat + sonicated + post heat (Chandrapala, J., Zisu, B., Palmer, M. *et al.*, unpublished).

change the reactive thiol content (Taylor and Richardson, 1980b; Chandrapala *et al.*, 2011) suggesting that the protein secondary structure remained largely intact without exposing thiol groups. The heat exposed thiol groups also remained unchanged following sonication. The results indicated that sonication after a preheat treatment does not influence the reactive thiol groups, and hence the aggregation behaviour of reconstituted WPC.

Electrostatic interactions and repulsions also play an important role in the aggregation of whey proteins and Figure 6.17b shows that the surface charge of native WPC solutions at about 27 mV remained unchanged after sonication. Neither preheating nor a combination of pre and post-heating changed the surface charge. Similarly, the surface charge of preheated and sonicated protein solutions showed no significant difference indicating that electrostatic interactions are unlikely to play a role in the heat stability process.

The importance of hydrophobic interactions for the stability, conformation, and function of proteins is well recognized. Due to the macromolecular structure of proteins, the surface hydrophobicity characteristics affect functionality to a greater extent than the total hydrophobicity. Surface hydrophobicity influences intermolecular interactions, such as binding of small ligands or association with other macromolecules, including protein–protein interactions (Haskard and Li-Chan, 1998). Figure 6.17c shows the surface hydrophobicity of reconstituted WPC solutions. Whey proteins contain a high proportion of hydrophobic amino acid chains that become exposed during heat treatment; preheating increased the surface hydrophobicity of the whey proteins, which increased further after post-heating. Kato *et al.* (1983) reported an increase in surface hydrophobicity of β -LG solution at pH 7.0 that was heated at 75–90°C for 30 minutes. Alizadeh-Pasdar and Li-Chan (2000) investigated the surface hydrophobicity of whey protein isolate and β -LG heated at 80°C for 30 minutes using ANS (8-anilino-1-naphthalene-sulfonate) and also showed an increase in surface hydrophobicity after heating. This is consistent with data obtained by Nakai (1983), Mleko *et al.* (1997) and Monahan *et al.* (1995). In contrast, sonication alone did not increase the surface hydrophobicity ($p > 0.05$) and, interestingly, sonication appears to reverse the heat-induced surface hydrophobicity activity, as the surface hydrophobicity of the preheated solutions was significantly lower after sonication than preheating alone ($p < 0.05$). Further heating did not increase the surface hydrophobicity, indicating that ultrasound also acts as a termination step.

Since neither thiol–disulfide interchange reactions nor electrostatic interactions play a significant role in the aggregation behaviour of whey proteins after partial heat denaturation at $\geq 80^\circ\text{C}$ and sonication at 20 kHz, it is likely that physical shear generated through acoustic cavitation lowers the surface hydrophobicity, which prevents heat-induced re-aggregation of proteins through hydrophobic interactions, thereby improving the heat stability of whey proteins.

6.11 Sensory Characteristics of Sonicated Milk and Whey

Few studies have considered the sensory characteristics of sonicated milk or whey products, with a single study characterizing the volatile compounds generated in milk (Riener *et al.*, 2009a) and another that examined the sensory characteristics of sonicated whey (Martini and Walsh, 2012).

A 24 kHz ultrasonic processor was used to batch treat a commercial sample of pasteurized and homogenized milk containing 1.5% fat for 2.5, 5, 10, 15 and 20 minutes at 45°C (Riener *et al.*, 2009a). Solid phase microextraction headspace analysis was used in combination with gas chromatography/mass spectrometry to detect some volatile compounds generated by sonication; these compounds were believed to result from high localized temperatures associated with cavitation. A weak and ‘ill defined’ aroma described as ‘rubbery’ was identified. Taking into consideration that the odour described was based on high intensity batch sonication with significantly long contact times, this observation may not be representative of all processing conditions. Batch sonicating 200 ml of milk at 400W for 2.5–20 minutes as described by Riener *et al.* (2009a) would deliver an energy density of 300–2,400 J/ml. In an unrelated study there was no unusual odour detected using continuous sonication to treat concentrated milk delivering a significantly lower energy density of 4–7 J/ml with 10 seconds contact time (sonication process described by Zisu *et al.*, 2013).

In a separate study, liquid whey containing 28.2% solids including 10% total protein was sonicated for 15 minutes at a frequency of 20 kHz (Martini and Walsh, 2012). With the aid of a trained sensory panel, 21 sensory attributes of sonicated whey were compared against an unsonicated control at pH 3.5, 4.5 and 7.5. Nose clips were used when evaluating taste only. Delivering an energy density of 270 J/ml (based on a 50 ml sample batch sonicated at 15W for 15 minutes), the study concluded that ultrasound did not change the sensory attributes of the whey and two detrimental attributes described as ‘cardboard’ and ‘malty’ actually scored lower than the control.

6.12 Conclusions

Ultrasound has numerous applications in dairy ranging from microbial reduction to tailoring ingredient functionality. Although the majority of these applications are only proven in the laboratory, some have been successfully implemented on a larger scale. Much can be learned from other industries that have made the successful transition to industrial commercialization and the best example is crystallization. Although some of the applications covered in this chapter may never reach commercialization, it is the applications that deliver the greatest benefit with the lowest requirement for energy that stand the greatest chance. Outstanding opportunities for power ultrasound to develop further include rehydration of powders to improve solubility, viscosity control (in particular protein concentrates with potential to control age thickening), the ability to improve the heat stability of whey proteins for high temperature processing and rapid sonocrystallization of lactose.

References

- Adekunte, A., Valdramidis, V.P., Tiwari, B.K. *et al.* (2010) Resistance of *Cronobacter sakazakii* in reconstituted powdered infant formula during ultrasound at controlled temperatures: A quantitative approach on microbial responses. *International Journal of Food Microbiology*, **142**: 53–59.
- Alizadeh-Pasdar, N. and Lichan, C.Y. (2000) Comparison of protein surface hydrophobicity measured at various pH values using three different fluorescent probes. *Journal of Agricultural and Food Chemistry*, **48**: 328–334.

- Anema, S.G., Pinder, D.N., Hunter, R.J. and Hemar, Y. (2006) Effects of storage temperature on the solubility of milk protein concentrate (MPC85). *Food Hydrocolloids*, **20**: 386–393.
- Arnold, G., Leiteritz, L., Zahn, S. and Rohm, H. (2009) Ultrasonic cutting of cheese: Composition affects cutting work reduction and energy demand. *International Dairy Journal*, **19**: 314–320.
- Ashokkumar, M. and Mason, T.J. (2007) *Sonochemistry*. Kirk-Othmer Encyclopedia of Chemical Technology, John Wiley and Sons, Ltd.
- Ashokkumar, M., Lee, J., Kentish, S. and Grieser, F. (2004) Bubbles in an acoustic field: An overview. *Ultrasonics Sonochemistry*, **14**: 470–475.
- Ashokkumar, M., Sunarito, D., Kentish, S. *et al.* (2008) Modification of food ingredients by ultrasound to improve functionality: A preliminary study on a model system. *Innovative Food Science and Emerging Technologies*, **9** (2): 155–160.
- Ashokkumar, M., Kentish, S.E., Lee, J. *et al.* (2009a) Processing of dairy ingredients by ultra-sonication. PCT International Patent Application WO2009/079691.
- Ashokkumar, M., Lee, J., Zisu, B. *et al.* (2009b) Hot topic: Sonication increases the heat stability of whey proteins. *Journal of Dairy Science*, **92**: 5353–5356.
- Ashokkumar, M., Bhaskaracharya, R., Kentish, S.E. *et al.* (2010) The ultrasonic processing of dairy products – An overview. *Dairy Science and Technology*, **90** (2–3): 147–168.
- Bates, D.M. and Bagnall, W. (2011) Viscosity reduction. US Patent 2011/0278153 A1.
- Bermudez-Aguirre, D. and Barbosa-Canovas, G.V. (2008) Study of butter fat content in milk on the inactivation of *Listeria innocua* ATCC 51742 by thermo-sonication. *Innovative Food Science and Emerging Technologies*, **9** (2): 176–185.
- Bermudez-Aguirre, D. and Barbosa-Canovas, G.V. (2010) Processing of soft Hispanic cheese ('Queso Fresco') using thermo-sonicated milk: A study of physicochemical characteristics and storage life. *Journal of Food Science*, **75** (9): S548-S558.
- Bermudez-Aguirre, D., Mawson R. and Barbosa-Canovas, G.V. (2008) Microstructure of fat globules in whole milk after thermosonication treatment. *Journal of Food Science* **73**: 325–332.
- Bermudez-Aguirre, D., Corradini, M.G., Mawson, R. and Barbosa-Canovas, G.V. (2009a) Modeling the inactivation of *Listeria innocua* in raw whole milk treated under thermo-sonication. *Innovative Food Science and Emerging Technologies*, **10**: 172–178.
- Bermudez-Aguirre, D., Mawson, R., Versteeg, K. and Barbosa-Canovas, G.V. (2009b) Composition parameters, physical-chemical characteristics and shelf-life of whole milk after thermal and thermo-sonication treatments. *Journal of Food Quality*, **32**: 283–302.
- Bienvenue, A., Jimenez-Flores, R. and Singh, J.H. (2003) Rheological properties of concentrated skim milk: importance of soluble minerals in the changes in viscosity during storage. *Journal of Dairy Science*, **86**: 3813–3821.
- Bosiljkov, T., Tripalo, B., Brncic, M. *et al.* (2011) Influence of high intensity ultrasound with different probe diameter on the degree of homogenization (variance) and physical properties of cow milk. *African Journal of Biotechnology*, **10** (1): 34–41.
- Bund, R.K. and Pandit, A.B. (2007) Sonocrystallization: Effect on lactose recovery and crystal habit. *Ultrasonics Sonochemistry*, **14** (2): 143–152.
- Caia, M., Wanga, S., Zheng, Y. and Lianga, H. (2009) Effects of ultrasound on ultrafiltration of *Radix astragalus* extract and cleaning of fouled membrane. *Separation and Purification Technology*, **68**: 351–356.
- Cameron, M., McMaster, L.D. and Britz, T.J. (2009) Impact of ultrasound on dairy spoilage microbes and milk components. *Dairy Science and Technology*, **89**: 83–98.

- Cardamone, M. and Puri, N.K. (1992) Spectrofluorimetric assessment of the surface hydrophobicity of proteins. *Biochemical Journal*, **282**: 589–593.
- Castro, M.D.L. and Priego-Capote, F. (2007) Ultrasound-assisted crystallization. *Ultrasonics Sonochemistry*, **14** (6): 717–724.
- Chai, X., Kobayashi, T. and Fujii, N. (1999) Ultrasound-associated cleaning of polymeric membranes for water treatment. *Separation and Purification Technology*, **15**: 139–146.
- Chandrapala, J., Zisu, B., Palmer, M. *et al.* (2011) Effects of ultrasound on the thermal and structural characteristics of proteins in reconstituted whey protein concentrate. *Ultrasonics Sonochemistry*, **18**: 951–957.
- Chandrapala, J., Martin, G.J.O., Zisu, B. *et al.* (2012a) The effect of ultrasound on casein micelle integrity. *Journal of Dairy Science*, **95**: 6882–6890.
- Chandrapala, J., Zisu, B., Kentish, S. and Ashokkumar, M. (2012b) The effects of high-intensity ultrasound on the structural and functional properties of α -Lactalbumin, β -Lactoglobulin and their mixtures. *Food Research International*, **48**: 940–943.
- Chemat, F., Zill-e-Huma, Khan M.K. (2011) Applications of ultrasound in food technology: processing, preservation and extraction. *Ultrasonics Sonochemistry*, **18**: 813–835.
- Ciawi, E., Rae, J., Ashokkumar, M. and Grieser, F. (2006) Determination of temperatures within acoustically generated bubbles in aqueous solutions at different US frequencies. *Journal of Physical Chemistry*, **110**: 13656–13660.
- Czank, C., Simmer, K. and Hartmann, P.E. (2010) Simultaneous pasteurization and homogenization of human milk by combining heat and ultrasound: effect on milk quality. *Journal of Dairy Research*, **77**: 183–189.
- Dalgleish, D.G. (2011) On the structural models of bovine casein micelles – review and possible improvements. *Soft Matter*, **7**: 2265–2272.
- Dhumal, R.S., Biradar, S.V., Paradkar, A.R. and York, P. (2008) Ultrasound assisted engineering of lactose crystals. *Pharmaceutical Research*, **25** (12): 2835–2844.
- Dolatowski, Z.J., Stadnik, J. and Stasiak, D. (2007) Applications of ultrasound in food technology. *ACTA Scientiarum Polonorum*, **6** (3): 89–99.
- Drakopoulou, S., Terzakis, S., Fountoulakis, M.S. *et al.* (2009) Ultrasound-induced inactivation of gram-negative and gram-positive bacteria in secondary treatment municipal water. *Ultrasonics Sonochemistry*, **16**: 629–634.
- Earnshaw, R.G. (1998) Ultrasound: A new opportunity for food preservation. In *Ultrasound in Food Processing* (eds M.J.W. Povey and T.J. Mason). Blackie Academic and Professional, London, pp. 183–192.
- Earnshaw, R.G., Appleyard, J. and Hurst, R.M. (1995) Understanding physical inactivation processes: Combined preservation opportunities using heat, ultrasound and pressure. *International Journal of Applied Microbiology*, **28**: 197–219.
- Fang, Y., Selomulya, C., Ainsworth, S. *et al.* (2011) On quantifying the dissolution behavior of milk protein concentrate. *Food Hydrocolloids*, **25**: 503–510.
- Feng, H., Yang, W. and Hielscher, T. (2008) Power ultrasound. *Food Science and Technology International*, **14** (5): 433.
- Gaiani, C., Boyanova, P., Hussain, R. *et al.* (2011) Morphological descriptors and color as a tool to better understand rehydration properties of dairy powders. *International Dairy Journal*, **21**: 462–469.
- Garcia, M.L., Burgos, J., Sanz, B. and Ordonez, J.A. (1989) Effect of heat and ultrasonic waves on the survival of two strains of *Bacillus subtilis*. *Journal of Applied Bacteriology*, **67**: 619–628.

- GEA NIRO (2010) *Milk Powder Technology – Evaporation and Spray Drying*, 5th edn. GEA Process Engineering A/S, Soborg Denmark, p. 254.
- Gera, N. and Doores, S. (2011) Kinetics and mechanisms of bacterial inactivation by ultrasound waves and sonoprotective effect of milk components. *Journal of Food Science*, **76**: M111-M119.
- Gordon, L. and Pilosof, A. (2010) Application of high-intensity ultrasound to control the size of whey protein particles. *Food Biophysics*, **5**: 201–210.
- Gulseren, I., Guzey, D., Bruce, B. and Weiss, J. (2007) Structural and functional changes in ultrasonicated bovine serum albumin solutions. *Ultrasonics Sonochemistry*, **14**: 173–183.
- Guo, Z., Zhang, M., Li, H. *et al.* (2005) Effect of ultrasound on anti-solvent crystallization process. *Journal of Crystal Growth*, **273** (3–4): 555–563.
- Hashizume, K. and Sato T. (1988) Gel forming characteristics of milk proteins. 2. Roles of sulfhydryl groups and disulfide bonds. *Journal of Dairy Research*, **71**: 1447–1454.
- Haskard, C.A. and Lichan, C.Y. (1998) Hydrophobicity of bovine serum albumin and ovalbumin determined using uncharged (prodan) and anionic (ans) fluorescent probes. *Journal of Agricultural and Food Chemistry*, **46**: 2671–2677.
- Havea, P. (2006) Protein interactions in milk protein concentrate powders. *International Dairy Journal*, **16** (5): 415–422.
- Hem, S.L. (1967) The effect of ultrasonic vibrations on crystallization processes. *Ultrasonics* **5** (4): 202–207.
- Hielscher (2012) *Hielscher – Ultrasound Technology* (www.hielscher.com; last accessed 3 January 2015).
- Jambrak, A.R., Mason, T.J., Lelas, V. *et al.* (2008) Effect of ultrasound treatment on solubility and foaming properties of whey protein suspensions. *Journal of Food Engineering*, **86**: 281–287.
- Juang, R. and Lin, K. (2004) Flux recovery in the ultrafiltration of suspended solutions with ultrasound. *Journal of Membrane Science*, **243**: 115–124.
- Juliano, P., Kutter, A., Cheng, L.J. *et al.* (2011) Enhanced creaming of milk fat globules in milk emulsions by the application of ultrasound and detection by means of optical methods. *Ultrasonics Sonochemistry*, **18**: 963–973.
- Kato, A., Osako, Y., Matsudomi, N. and Kobayashi, K. (1983) Changes in the emulsifying and foaming properties of proteins during heat denaturation. *Agricultural Biological Chemistry*, **47**: 33–37.
- Kentish, S., Wooster, T.J., Ashokkumar, M. *et al.* (2008) The use of ultrasonics for nanoemulsion preparation. *Innovative Food Science and Emerging Technologies*, **9**: 170–175.
- Knipschildt, M.E. and Andersen, G.G. (1997) Drying of milk and milk product. In *Modern Dairy Technology* (ed. R.K. Robinson). Chapman and Hall, London, pp. 173–175.
- Kobayashi, T., Chai, X. and Fuji, N. (1999) Ultrasound enhanced cross flow membrane filtration. *Separation and Purification Technology*, **17**: 31–40.
- Kresic, G., Lelas, V., Jambrak, A.R. *et al.* (2008) Influence of novel food processing technologies on the rheological and thermophysical properties of whey proteins. *Journal of Food Engineering*, **87**: 64–73.
- Laborde, J.L., Bouyer, C., Caltagirone, J.P. and Gerard, A. (1998). Acoustic bubble cavitation at low frequencies. *Ultrasonics*, **36** (1–5): 589–594.
- Lamminen, M.O., Walker, H.W. and Weavers, L.K. (2004) Mechanisms and factors influencing the ultrasonic cleaning of particle-fouled ceramic membranes. *Journal of Membrane Science*, **237**: 213–223.

- Li, H., Li, H., Guo, Z. and Liu, Y. (2006) The application of power ultrasound to reaction crystallization. *Ultrasonics Sonochemistry*, **13** (4): 359–363.
- Lucena, M.E., Alvarez, S., Menendez, C. *et al.* (2006) Beta-Lactoglobulin removal from whey protein concentrates production of milk derivatives as a base for infant formulas. *Separation and Purification Technology*, **52**: 310–316.
- Luque de Castro, M.D. and Priego-Capote, F. (2007) Ultrasound assisted crystallization (sonocrystallization). *Ultrasonics Sonochemistry*, **14**: 717–724.
- Madadlou, A., Emam-Djomeh, Z., Mousavi, M.E. *et al.* (2009a) Acid-induced gelation behavior of sonicated casein solutions. *Ultrasonics Sonochemistry*, **17** (1): 153–158.
- Madadlou, A., Mousavi, M.E., Emam-Djomeh, Z. *et al.* (2009b) Sonodisruption of re-assembled casein micelles at different pH values. *Ultrasonics Sonochemistry*, **16**: 644–648.
- Martin, G.J.O., Williams, R.P.W. and Dunstan D. (2007) Comparison of casein micelles in raw and reconstituted skim milk. *Journal of Dairy Science*, **90**: 4543–4551.
- Martini, S. and Walsh, M.K. (2012) Sensory characteristics and functionality of sonicated whey. *Food Research International*, **49**: 694–701.
- Maskooki, A., Mortazavi, S. and Maskooki, A. (2008) Cleaning of spiralwound ultrafiltration membranes using ultrasound and alkaline solution of EDTA. *Desalination*, **264** (1–2): 63–69.
- Maskooki, A., Kobayashi, T., Mortazavi, S.A. and Maskooki, A. (2010) Effect of low frequencies and mixed wave of ultrasound and EDTA on flux recovery and cleaning of microfiltration membranes. *Separation and Purification Technology*, **59**: 67–73.
- Mason, T.J. (1998) Power ultrasound in food processing – the way forward. In *Ultrasound in Food Processing* (eds M.J.W. Povey and T.J. Mason). Blackie Academic and Professional, London, pp. 105–126.
- Mason, T., Riera, E., Vercet, A. and Lopez-Buesa, P. (2005) Applications of ultrasound. In *Emerging Technologies for Food Processing* (ed. D.-W. Sun). Elsevier Academic Press, London, pp. 323–351.
- McKenna, A.B., Lloyd, R.J., Munro, P.A. and Singh, H. (1999) Microstructure of whole milk powder and of insolubles detected by powder functional testing. *Scanning*, **21**: 305–315.
- Mimouni, A., Deeth, H.C., Whittaker, A.K. *et al.* (2009) Rehydration process of milk protein concentrate powder monitored by static light scattering. *Food Hydrocolloids*, **23**: 1958–1965.
- Mleko, S., Li-chan, E.C.Y. and Pikus, S. (1997) Interactions of κ -carrageenan with whey proteins in gels formed at different pH. *Food Research International*, **30**: 427–433.
- Monahan, F.J., German, J.B. and Kinsella, J.E. (1995) Effect of pH and temperature on protein unfolding and thiol disulfide interchange reactions during heat induced gelation of whey proteins. *Journal of Agricultural and Food Chemistry*, **43**: 46–52.
- Morr, C.V. and Richter, R.L., (1999) Chemistry of Processing. Pages. In *Fundamentals of Dairy Chemistry*, 3rd edn (eds N.P. Wong, R. Jenness, M. Keeney and E.H. Marth). Aspen Publishers, Gaithersburg, MD, pp. 739–766.
- Mulet, A., Carcel J.A., Sanjuan, N. and Bon, J. (2003) New food drying technologies-use of ultrasound. *Food Science and Technology International*, **9**: 215–221.
- Muthukumar, S., Yang, K., Seuren, A. *et al.* (2004) The use of ultrasonic cleaning for UF membranes in dairy industry. *Separation and Purification Technology*, **39**: 99–107.
- Muthukumar, S., Kentish, S.E., Ashokkumar, M. and Stevens, G.W. (2005a) Mechanisms for the ultrasonic enhancement of dairy whey ultrafiltration. *Journal of Membrane Science*, **258**: 106–114.

- Muthukumar, S., Kentish, S., Lalchandani, S. *et al.* (2005b) The optimization of ultrasonic cleaning procedures for dairy fouled ultrafiltration. *Ultrasonics Sonochemistry*, **12**: 29–35.
- Muthukumar, S., Kentish, S., Stevens, G.W. *et al.* (2007) The application of ultrasound to dairy ultrafiltration – The influence of operating conditions. *Journal of Food Engineering*, **81**: 364–373.
- Nakai, S. (1983) Structure-function relationships of food proteins with an emphasis on the importance of protein hydrophobicity. *Journal of Agricultural and Food Chemistry*, **31**: 676–683.
- Nguyen, N.H.A. and Anema S.G. (2010) Effect of ultrasonication on the properties of skim milk used in the formation of acid gels. *Innovative Food Science and Emerging Technologies*, **11**: 616–622.
- Nii, S., Kikumoto, S. and Tokuyama, H. (2009) Quantitative approach to ultrasonic emulsion separation. *Ultrasonics Sonochemistry*, **16**: 145–149.
- NIZO (2010) Green Dairy Team Consortium Started. *NIZO Vision*, **17**: 4 [E-newsletter, NIZO Food Research BV, Ede, The Netherlands] (www.nizo.com; last accessed 3 January 2015).
- Onwulata, C.I., Konstance, R.P. and Tomasula, P.M. (2002) Viscous properties of microparticulated dairy proteins and sucrose. *Journal of Dairy Science*, **85**: 1677–1683.
- Ordonez, J.A., Aguilera, M.A., Garcia, M.L. and Sanz, B. (1987) Effect of combined ultrasonic and heat treatment (thermoultrasonication) on the survival of a strain of *Staphylococcus aureus*. *Journal of Dairy Research*, **54** (1): 61–67.
- Patrick, P.S. and Swaisgood, H.E. (1976) Sulfhydryl and disulfide groups in skim milk as affected by direct ultra high temperature heating and subsequent storage. *Journal of Dairy Science*, **59**: 594–600.
- Popovic, S., Djuric, M., Milanovic, S. *et al.* (2010) Application of an ultrasound field in chemical cleaning of ceramic tubular membrane fouled with whey proteins. *Journal of Food Engineering*, **101** (3): 296–302.
- Prosonix, (2012) *Revolutionizing Respiratory Medicine* (www.prosonix.co.uk; last accessed 3 January 2015).
- Riener, J., Noci, F., Cronin, D.A. *et al.* (2009a) Characterization of volatile compounds generated in milk by high intensity ultrasound. *International Dairy Journal*, **19**: 269–272.
- Riener, J., Noci, F., Cronin, D.A. *et al.* (2009b) The effect of thermosonication of milk on selected physicochemical and microstructural properties of yoghurt gels during fermentation. *Food Chemistry*, **114**: 905–911.
- Riener, J., Noci, F., Cronin, D.A. *et al.* (2010) A comparison of selected quality characteristics of yoghurts prepared from thermosonicated and conventionally heated milks. *Food Chemistry*, **119**: 1108–1110.
- Snoeren, T.H.M., Brinkhuis, J.A., Damman, A.J. and Klok, H.J. (1982) The viscosity of skim-milk concentrates. *Netherlands Milk and Dairy Journal*, **36**: 305–316.
- Taylor, M.J. and Richardson, T. (1980a) Antioxidant activity of skim milk: effect of heat and resultant sulfhydryl groups. *Journal of Dairy Science*, **63**: 1783–1795.
- Taylor, M.J. and Richardson, T. (1980b) Antioxidant activity of skim milk: effect of sonication. *Journal of Dairy Science*, **63**: 1938–1942.
- Tenga, M., Lina, S. and Juang, R. (2006) Effect of ultrasound on the separation of binary protein mixtures by cross-flow ultrafiltration. *Desalination*, **200**: 280–282.
- Tsioulpas, A., Lewis, M.J., and Grandison, A.S. (2007) Effect of minerals on casein micelle stability of cows' milk. *Journal of Dairy Research*, **74**: 167–173.

- Ueno, S., Ristic, R.I., Higaki, K. and Sato, K. (2003) *In situ* studies of ultrasound-stimulated fat crystallization using synchrotron radiation. *The Journal of Physical Chemistry*, **107** (21): 4927–4935.
- Vercet, A., Oria, R., Marquina, P. *et al.* (2002) Rheological properties of yoghurt made with milk submitted to manothermosonication. *Journal of Agricultural and Food Chemistry*, **50**: 6165–6171.
- Villamiel, M. and de Jong, P. (2000) Influence of high-intensity ultrasound and heat treatment in continuous flow on fat, proteins, and native enzymes of milk. *Journal of Agricultural and Food Chemistry*, **48**: 472–478.
- Villamiel, M., van Hamersveld, E.H. and de Jong, P. (1999) Review: Effect of ultrasound processing on the quality of dairy products. *Milchwissenschaft*, **54** (2): 69–73.
- Villamiel, M., Verdurmen, R. and de Jong, P. (2000) Degassing of milk by high-intensity ultrasound. *Milchwissenschaft*, **5** (3): 123–125.
- Wang, Q., Tolkach, A. and Kulozik, U. (2006) Quantitative assessment of thermal denaturation of bovine α -Lactalbumin via low-intensity ultrasound, HPLC and DSC. *Journal of Agricultural and Food Chemistry*, **54**: 6501–6506.
- Westergaard, V. (2004) *Milk powder technology evaporation and spray drying*. GEA Niro, Copenhagen, Denmark.
- Wood, E.W. and Loomis, A.L. (1927) The physical and biological effects of high-frequency sound-waves of great intensity. *Philosophical Magazine*, **4** (22): 417–436.
- Wrigley, D.M. and Llorca, H.G. (1992) Decrease of *Salmonella typhimurium* in skim milk and egg by heat and ultrasonic wave treatment. *Journal of Food Protection*, **55** (9): 678–680.
- Wu, H., Hulbert, G.J. and Mount, J.R. (2001) Effects of ultrasound on milk homogenization and fermentation with yoghurt starter. *Innovative Food Science and Emerging Technologies*, **1**: 211–218.
- Zenker, M., Heinz, V. and Knorr, D. (2003) Application of ultrasound-assisted thermal processing for preservation and quality retention of liquid foods. *Journal of Food Protection*, **66** (9): 1642–1649.
- Zisu, B., Bhaskaracharya, R., Kentish, S. and Ashokkumar, M. (2010) Ultrasonic processing of dairy systems in large scale reactors. *Ultrasonics Sonochemistry*, **17**: 1075–1081.
- Zisu, B., Lee, J., Chandrapala, J. *et al.* (2011) Effect of ultrasound on the physical and functional properties of reconstituted whey protein powders. *Journal of Dairy Research*, **78** (2): 226–232.
- Zisu, B., Schleyer, M. and Chandrapala, J. (2013) Application of ultrasound to reduce viscosity and control the rate of age thickening of concentrated skim milk. *International Dairy Journal*, **31**: 41–43.
- Zwijgers, A. (1992) Outline of milk protein concentrate. *International Food Ingredients*, **3**: 18–23.

7

Ultraviolet and Pulsed Light Technologies in Dairy Processing

Nivedita Datta¹, Poornimaa Harimurugan¹, and Enzo A. Palombo²

¹*College of Health and Biomedicine, Victoria University, Australia*

²*Department of Chemistry and Biotechnology, Faculty of Science, Engineering and Technology, Swinburne University of Technology, Australia*

7.1 Introduction

The dairy industry is the fastest growing agricultural sector in the world and use of dairy products is expected to rise by 30% by 2021. Global milk production was estimated to be about 784 million tonnes in 2013 (FAO, 2013) and is estimated to be 880 million tonnes in 2021 (FAO, 2012). Thus, there is a need to develop novel processing techniques to meet global demand. Thermal processes, such as pasteurization and ultra high temperature (UHT) treatment, are traditionally used in dairy processing. Recently, nonthermal technologies have been introduced as an alternative to thermal processing and have gained considerable public interest in preventing the damage of nutrients that would otherwise occur during heat treatment of food (Engin and Karagul, 2012). The dairy industry is equally interested in employing these innovative technologies to improve the quality of milk and dairy products. Another potential application of nonthermal technologies is processing of heat-sensitive dairy ingredients. The functional heat-labile bioactive components from dairy sources, such as lactoperoxidase, lysozyme, lactoferrin and immunoglobulin, have captured a significant market (Deeth *et al.*, 2013). There are several nonthermal techniques that have shown significant contributions in the food industry. Of these, high-pressure processing, pulsed electric field processing, ultrasonication and ultraviolet (UV) light technology are commercially successful in improving quality and shelf life of food products (Hembry, 2008).

UV radiation has gained considerable attention in food processing because it can cause a substantial reduction of microorganisms without loss of colour, flavour and

vitamins (Choudhary *et al.*, 2011). Currently, UV radiation is used for microbial inactivation in water purification plants in the USA (FDA, 2009). Five hundred UV plants in North America and 2000 plants in Europe are using UV technology for water purification (Pereira and Vicente, 2010.) The disinfectant capacity of UV light is widely used to inactivate microorganisms in syrups, incoming water, clean-in-place water, waste water, filter systems and packaging surfaces in the brewing and beverage industries and in brine and whey in the cheese industry. The FDA has permitted the commercial use of UV light (21 CFR 179.39 for UV radiation and 21 CFR 179.41 for pulsed light) for fruit and vegetable juices processing at refrigerated storage conditions since November 2000. The energy requirement for UV treatment of fruit juices, (2 kW h m^{-3}) was found to be much smaller than that for thermal processing (82 kW h m^{-3}) (Tran and Farid, 2004).

The striking feature of UV technology lies in the fact that microbial inactivation can be achieved at ambient temperature. UV treatment destroys most bacteria, such as *Listeria*, *Escherichia coli*, *Salmonella*, *Bacillus* (including endospores) and *Mycobacterium perafortuitum*, protozoa such as *Cryptosporidium* and *Giardia*, viruses such as *Coxsackie*, *Influenza*, *Sindbis* and *Vassinia* in air, water and on surfaces (Josset *et al.*, 2007). UV treatment is capable of achieving 7–8 log reductions of total bacteria in whey and brine, indicating the usefulness of UV light in the cheese industry. About 3 log reductions of total bacteria including *coliforms* and spores is achieved in milk using 1.5 kJ/l. However, the maximum allowable UV dose to retain the sensory quality of the milk was reported to be 1kJ/l (Reinemann, 2006). Despite the known germicidal efficiency of UV light, pasteurization of milk using UV light treatment presents a major challenge owing to the turbidity of milk. Turbidity causes lower penetration of UV light and reduces the amount of microbial inactivation. The turbidity of milk, due to the presence of high levels of colloidal and suspended solids, causes the milk to be opaque to UV light; hence, the conventional apparatus for UV treatment used in water treatment is not appropriate for pasteurization purposes in the dairy industry. In order to increase the penetration of UV light into milk, two strategies based on the flow pattern of the fluid have been used in modern UV reactors, which actually opened up the application of the technology for pasteurization purposes in the food and dairy industries. One of the approaches uses laminar flow of milk/fluid through formation of an extremely thin film on an UV irradiated surface, resulting in complete penetration of light through milk. The second approach uses turbulent flow of milk to bring all parts of the liquid into close proximity to the surface exposed to UV light, thus decreasing the required path length and resulting in better penetration of UV light with milk. The advantages and issues are explained in Boxes 7.1 and 7.2.

Box 7.1 Advantages of UV light technology

- A nonthermal process at ambient temperature with low detrimental effects on chemical components such as protein, colour and flavour
- Reduces microbial load up to 8 log cycles based on the type of liquid and dosage levels
- Can be used for batch and continuous mode of treatment
- Low maintenance, installation and operation cost with minimum energy usage
- Does not produce any chemical residue
- Heat is not generated by the UV treatment
- No detrimental effects on the environment
- UV treatment set-up can be retrofitted into an existing plant
- Vitamin D enrichment in milk by the UV treatment.

Box 7.2 Issues with UV light technology

- Oxidation of protein in whole milk and skim milk occurs due to UV light and caused sensory defects (Scheidegger *et al.*, 2010)
- Results in decrease of vitamins C>E>A>B2 affecting the quality of milk (Guneser and Karagul Yuceer, 2012)
- Volatile compounds produced after UV treatment (Webster *et al.*, 2011) may alter the flavour profile of treated milk
- UV radiation cannot be used for translucent milk packaging
- Solid contents in milk and dairy products reduce the effectiveness of UV treatment (Guneser and Karagul Yuceer, 2012)
- Endospores of *Bacillus subtilis* were 5–50 times more resistant to UV light than the corresponding actively growing cells (Setlow, 2001)
- Efficiency is much lower in opaque or cloudy liquids (like milk)
- UV light damages human eyes, cause burns and skin cancer with prolonged exposure.

7.2 Basic Principles of UV Processing

UV rays can be classified as UV-A, UV-B and UV-C based on the emission wavelength. UV-A is defined as wavelengths between 315 and 400 nm, UV-B lies in the range 280–315 nm and UV-C remains from 200 to 280 nm as shown in Figure 7.1. UV-A is commonly used for water purification and UV-B is used for inducing plant growth. UV-C at particular wavelengths of 254–264 nm is used for inactivation of pathogens and other microorganisms in food (Choudhary and Bandla, 2012). The main purpose for using UV light in milk processing is microbial inactivation; hence, UV-C will be implied throughout this chapter when referring to UV light treatment. Mercury lamps transmit 85% UV light at 254 nm and 30°C is a suitable temperature for bacterial inactivation as the efficiency of UV light is low below 30°C (Matak *et al.*, 2005).

7.2.1 The UV Process

The bacterial killing process by UV treatment is a physical method in which the energy is introduced either onto the food surface or into the liquid medium. When UV energy

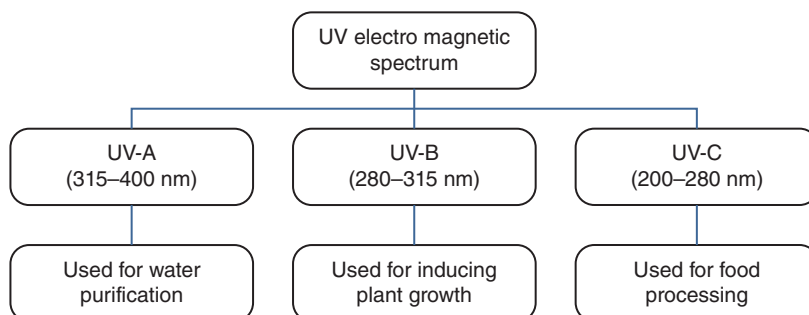

Figure 7.1 Types of UV rays and their uses.

Table 7.1 Absorption coefficient of liquids to UV light at 254 nm

Liquid	Absorption coefficient (α) (cm^{-1})
Distilled water	0.01 ^c
Drinking water	0.1 ^a
Clear syrup	2–5 ^c
Wine, white	10 ^c
Beer	10–20 ^c
Dark syrup	20–50 ^c
Wine, red	30 ^c
Apple juice	26 ^b
Guava juice	46 ^b
Orange juice	48 ^b
Carrot juice	53 ^b
Pineapple juice	73 ^b
Milk	300 ^a

^aShama (1999)^bKoutchma *et al.* (2007)^cPhilips (2006)

is introduced into liquid media, the germicidal energy of UV radiation is capable of penetrating liquids, although the intensity of UV light decreases due to attenuation and dissipation. Thus, the intensity of the light becomes lower as it travels further from its source due to dissipation. Similarly, the intensity of the UV light decreases because it interacts with molecules in the liquid medium (attenuation). If the liquid contains a high concentration of solids that absorb UV light, then less UV light will be transmitted into the liquid to kill the target bacteria. The amount of UV light absorbed per centimetre of liquid depth is expressed as the absorption coefficient (α). As this coefficient increases in various liquid media (Table 7.1), the transmissivity of UV light decreases exponentially. Therefore, the absorption coefficient of the medium plays a very important role in the effectiveness of the UV disinfection process. The high absorption coefficient (α) milk to UV light causes very poor transmission of UV light into milk and requires special mechanisms in order to achieve its highest efficiency in microbial disinfection.

The UV treatment system usually comprises a reaction chamber for UV light treatment in the form of concentric tubing or other designed tubes, a UV-C lamp, containers for the liquids, plastic tubing, a refrigeration system and pumps. An UV lamp surrounded by a quartz jacket is placed inside the concentric tube system. The liquid flows through the annular part of the tube to achieve the required germicidal effect. Thin films of liquid are used to increase the effective penetration of UV light into the liquids using the laminar flow of liquids. More than one concentric tubing system can be used to increase the germicidal effect on the liquid food without it being recirculated. In absence of thin film of liquid, the turbulent flow of the fluid is a critical parameter promoting improved penetration during UV processing and ensuring that all products receive the same UV dose. A well-mixed liquid product should have a treatment dose of at least 400 J/m² of UV radiation to attain at least a 5 log reduction of the microbial load (FDA, 2003). The critical process factors for UV treatment

include the absorption capacity of UV light of the dairy product, the geometric design of the UV reactor, the light characteristics (power, wavelength, intensity and duration) and physical arrangement of the UV source(s), and the flow profile of the treated milk/dairy products. UV radiation, known as nonionizing radiation, does not deliver any radioactivity to the treated product, in contrast to ionizing radiation (gamma radiation) which delivers residual radioactivity. The UV treatment is a dry and cold process and is not affected by water chemistry, unlike high-pressure processing. Low capital cost is involved either as a process or when introducing a continuous inline UV system, compared to other pasteurization methods (Higgins, 2001; Gailunas, 2003).

7.3 Available UV Treatment Equipment and Their Operation

In the early years (1920s–1940s), milk was treated with UV light for vitamin D enrichment in Germany and North America. It was reported that an increase of vitamin D content from 1 to 31 $\mu\text{g/l}$ was obtained using UV light treatment (Burton, 1951). The increased penetration of UV light into milk is caused by changing the flow patterns of milk; that is, either creating a laminar flow of milk through a thin film on an UV irradiated surface or making a turbulent flow of milk exposing all parts of milk to UV light with reduced path length (Koutchma, 2009).

Currently, the turbulent flow of milk is achieved by pumping milk at high velocity through a UV treatment reactor. The turbulent UV reactor is efficiently used to maximize the penetration of UV light into milk. This principle is incorporated in modern UV reactors (Altic *et al.*, 2007) and it is claimed that about 80% of the radiation penetrates into milk. One of the most common commercial UV pasteurizers, the CiderSure 3500 (Figure 7.2), is used to pasteurize apple cider without heat treatment. The CiderSure 3500 apparatus actually passes fluid (in laminar flow) as a thin film



Figure 7.2 CiderSure 3500 UV reactor. (Gomez-Lopez *et al.*, 2010. Reproduced with permission of Elsevier.



Figure 7.3 Taylor–Couette UV reactor. Gomez-Lopez *et al.*, 2010. Reproduced with permission of Elsevier.

on the UV exposed lamp, resulting in complete penetration of UV light into the fluid. This pasteurizer has also been used for milk processing in various studies (Matak *et al.*, 2005; Altic *et al.*, 2007). This reactor with eight lamps is manufactured by Oesco Inc (Conway, MA, USA) (Gómez-López *et al.*, 2012).

The Taylor–Couette reactor (Figure 7.3) consists of a concentric cylinder reactor with a rotating inner cylinder that mixes the target fluid in a radial direction. The pilot scale model of the Taylor–Couette UV reactor is used for water purification studies and is manufactured by Trojan UV Technologies Inc (Gómez-López *et al.*, 2012). This reactor is successfully used in the cheese industry to pasteurize whey and brine (Prasad *et al.*, 2011).

The combined techniques of thin film and concentric cylinder technology are used in the SurePure tubular UV module (SurePure Ltd, Milnerton, South Africa) for milk processing (Figure 7.4). The UV tubular reactor consists of both thin film and surface

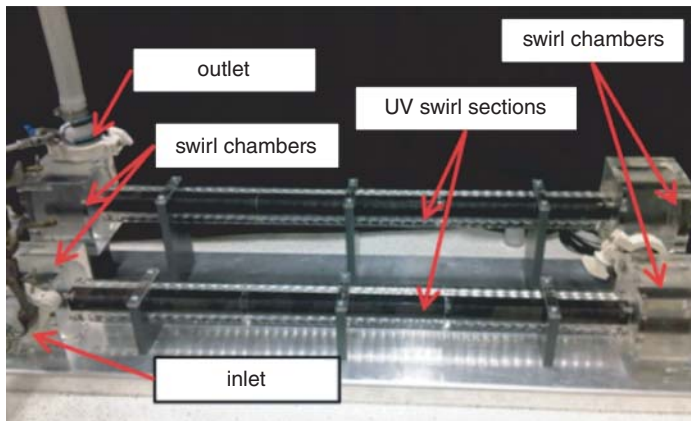

Figure 7.4 SurePure tubular UV reactor. Simmons *et al.*, 2012. Reproduced with permission of Elsevier.

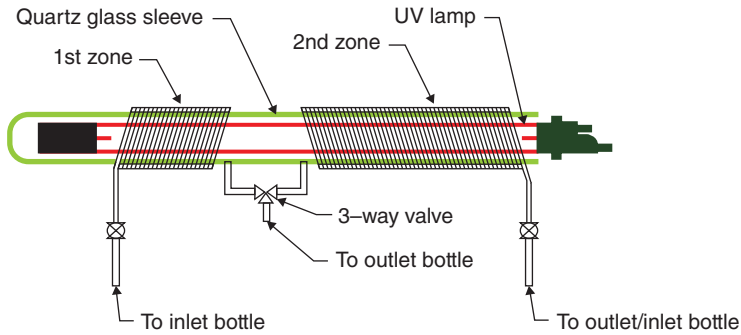

Figure 7.5 Coiled tube reactor. Bandla *et al.*, 2012. Reproduced with permission of Elsevier.

renewal design features using a swirling motion that brings the fluid into very close proximity of the UV irradiated surface. The tangential inlet of the fluid promotes a swirling flow in the UV reactor and the wavy inner wall tube design produces additional turbulence, leading to better penetration of UV light into the fluid. This reactor is used in milk and whey processing for pasteurization purposes in research laboratories (Simmons *et al.*, 2012).

The coiled tube endorses additional turbulence and causes a secondary eddy flow effect to create Dean vortices, also known as a Dean effect (Dean, 1927; Schmidt and Kauling, 2007), in the UV reactor (Figure 7.5). The resultant effect of Dean vortices demonstrates a more uniform liquid velocity and residence time of distribution and vigorous mixing of the target liquid in the area close to the UV energy input side. The Dean effect in the coiled surface promotes renewal surface of liquid and more turbulence, resulting in increased penetration of UV light within the liquid (Simmons *et al.*, 2012). The coiled tube reactor has been used to pasteurize milk and soy milk for research applications.

7.3.1 UV Dose Determination

The UV treatment dose (D) is defined as (Matak *et al.*, 2005; Keyser *et al.*, 2008):

$$D = I \times t \quad (7.1)$$

where D is the treatment dose (J/m^2 or Ws/m^2), I is the intensity or dosage rate, D_r (W/m^2) and t is the contact time/retention time for UV treatment (s)

In a continuous flow system, the contact time or retention time is obtained as:

$$t = \text{volume of UV reactor} / \text{flow rate of the treated liquid} \quad (7.2)$$

(assuming steady state operation and nonexpandable and nonvolatile characteristics of the treated liquid).

The conversion of UV dose from J/l to mJ/cm^2 and contact time at a particular fluid flow rate for an UV system is well described elsewhere (Keyser *et al.*, 2008).

7.3.2 UV Dose Measurement

There are three ways to measure UV dose in a UV irradiation process: radiometry, actinometry and biodosimetry.

The physical measurement of UV dose is performed through the use of radiometers or light sensors. The amount of UV radiation that strikes a surface over a specific time frame measures the illumination strength of UV light in the dose measurement. A digital or analogue output enables the measurement values to be exported to a PC and other instruments. Radiometers and sensors are able to respond to a narrow range of emitted wavelengths; they are limited by their sensitivity (Bolten and Linden, 2003).

Actinometers are based on chemical reactions used for measuring concentrations of light-induced products that are directly related to the amount of UV light absorbed in the photochemical reactions (Bolten and Linden, 2003). The actinometer measures the UV dose absorbed by a solution passing through on an irradiated surface. The yield of the iodide–iodate chemical actinometer (0.6 M KI–0.1 M KIO₃) is determined for irradiation between 214 and 330 nm. The photoproduct, triiodide, is determined from the increase in absorbance at 352 nm, which is used to determine the measurement of the UV fluence. The actinometer measures the photons (253.7 nm) in the iodide–iodate reaction that result in the photochemical conversion of iodide (I⁻) to tri-iodide (I³⁻) (Equation 7.3). Increased UV absorption is designated by increased formation of tri-iodide in the chemical reaction:

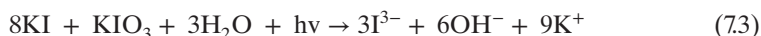

Biodosimetry, which is based on a biological method, consists of inoculating a surrogate microorganism into the liquid to be UV treated and measuring the log reduction after UV treatment of the liquid under specific conditions (Bolten and Linden, 2003). *E. coli* K12, which is a surrogate of *E. coli* O157:H7, is generally used in fruit juice products.

Biodosimetry is the most consistent technique for monitoring UV irradiance dose (Sastry *et al.*, 2000).

7.4 Effects of UV Treatment on Microorganisms

7.4.1 Mechanisms of Action

Microbial inactivation is caused by two significant effects involving DNA mutation and photo reactivation of microbial cells by UV treatment (Sastry *et al.*, 2000; Guerrero-Beltrán and Barbosa-Cánovas, 2004). The inactivation kinetics represent as a sigmoidal curve of log reduction, indicating a rapid decline in microbial survivors due to DNA mutation followed by photo-reactivation (Guerrero-Beltrán and Barbosa-Cánovas, 2004). The germicidal property of UV light is mainly due to alterations to the microbial DNA caused by cross-linking of the pyrimidine bases with the formation of cyclobutyl pyrimidine dimers. The extent of cross-linking is proportional to the treatment dose of UV light. The dimers block DNA transcription and replication by compromising cellular functions causing microbial cellular death

Table 7.2 Dosages required for microbial inactivation

Microorganism	Dose (J/m ²)
Bacteria (vegetative cell)	25
Viruses	45
Yeasts	66
Moulds	110
Algae	220
Bacteria (spores)	220
<i>Bacillus subtilis</i> (spores)	426

(Guerrero-Beltrán and Barbosa-Cánovas, 2004; Guneser and Karagul Yuceer, 2012). The photo-reactivation stage is a damage control step in the injured microorganisms using the repair enzymes (photolyase). Thus, the photo-reactivation stage increases the survival capacity of microorganisms and reduces the shelf life of the UV-treated product. It is essential to have an appropriate dosage of UV in order to make the products safer and to avoid the possibility of spoilage due to photo-reactivation. Therefore, storage conditions (e.g. a dark room) that prevent photo-reactivation of microorganisms in UV radiated foods are of utmost importance to achieve the desired control effects (Sastry, 2000; Guerrero-Beltrán and Barbosa-Cánovas, 2004).

7.4.2 Inactivation of Bacteria in Milk and Dairy Products

UV treatment of milk performed by German scientists was reviewed by Burton (1951), who reported that 99.9% of total bacteria can be inactivated. However, the keeping quality of milk was poor when compared with thermally pasteurized milk. The UV-treated product should contain at least 400 J/m² of UV light exposure in all parts of the product, which is the requirement for obtaining microbial inactivation in a pasteurization process (5 log reduction). Table 7.2 shows the dosage requirements (Falguera *et al.*, 2011) for inactivation of major groups of microorganisms using UV treatment.

It is evident from Table 7.2 that the UV dose required to inactivate viruses, yeasts, moulds and algae is much higher than for bacteria (Chang *et al.*, 1985; Morgan, 1989). In addition, bacterial inactivation using UV treatment is dependent on species, age of the organisms, number of cells and the presence of spores. Gram-negative bacteria *Pseudomonas*, *Escherichia* tend to be more susceptible to UV radiation than Gram-positive organisms *Bacillus*, *Staphylococcus* such that spore formers are more resistant than nonspore forming microorganisms (Jay, 1995). The appropriate UV treatment time for vegetative bacterial cell inactivation would be during the early lag phase, as the bacteria tend to be most resistant to UV radiation just prior to active cell division, during the lag phase. The lack of oxygen in the food medium also enhances bacterial resistance to UV radiation (Jay, 1995).

Matak *et al.* (2005) achieved more than 5 log reductions of *Listeria monocytogenes*, *Cryptosporidium parvuum* and *E. coli* in goats' milk using the CiderSure 3500UV

apparatus with a two second UV treatment of $158 \pm 16 \text{ J/m}^2$. The reduction of bacterial load along with sensory impairment was also observed. A significant difference was observed between the odour of fresh goat's milk and UV-treated milk, which correlated with the formation of volatile carbonyl compounds, for example pentanal, hexanal and heptanal, produced by UV-induced oxidation (Matak *et al.*, 2005).

Reinemann *et al.* (2006) reported a 2–3 log reduction in aerobic bacteria, yeasts and moulds, coliforms (including *E. coli*) and psychrotrophs in UV-treated milk at a dose of 1.5 kJ/l. The coliforms showed the greatest reduction while spore formers demonstrated the least reduction. However, the maximum allowable UV treatment to retain the sensory quality of the milk was reported to be 1.0 kJ/l. Thus, the results indicated that UV treatments required to achieve an acceptable reduction of bacteria in milk would cause sensory impairment.

Mycobacterium avium subsp paratuberculosis (MAP) in semi-skimmed and whole milk was reduced by 0.5–1 log with a UV dose of 1 kJ/l due to the high resistance of bacteria to UV light (Altic *et al.*, 2007). Similar results were found by Donaghy *et al.* (2009) during the inactivation of *Mycobacterium avium subsp paratuberculosis* (MAP) in UHT milk with UV dose ranges from 0 to 1.84 kJ/l in a pilot scale UV reactor. Only 0.1–0.6 log reductions were achieved at a dose level of 1.0 kJ/l and altered sensitivity to UV treatment was detected between strains of MAP.

The recently developed coiled tube UV reactor, which was previously discussed and is shown in Figure 7.5, was examined for inactivation efficiency of *E. coli* W 1485 and *Bacillus cereus* spores in raw whole milk, pasteurized skimmed milk and soymilk using the total UV dose of 111.87 J/m^2 for a residence time of 11.3 seconds (Choudhary *et al.*, 2011). The results showed more than a 7 log reduction of *E. coli* W 1485 in skimmed milk, more than a 5 log reduction in soymilk and a 4 log reduction in raw whole milk. A higher UV dose for whole milk than skimmed milk was recommended due to the UV light scattering effect by the fat particles present in the raw milk, which result in lower UV light transmission.

The reduction of the natural microorganisms of raw whole milk by UV treatment and the sensory and chemical properties of treated milk processed in a coiled tube UV reactor were investigated by Bandla *et al.* (2012). The objective of the research was to determine whether UV processing of whole milk caused any alteration in the flavour profile. The total UV dose for this treatment was 168.22 J/m^2 and the residence time of milk in the tube reactor was 17 seconds; with this residence time, the equivalent UV dose becomes 0.08 kJ/l. UV treatment of raw bovine milk reduced the standard plate count (SPC; an indicator of the natural microbial quality of milk) from 4.2 log of initial microbiota present in raw whole milk to 1.9 log, thus affecting a 2.3 log reduction under these conditions. Reinmann *et al.* (2006) reported that a 3 log reduction of SPC was achieved from the initial natural microbiota of 7 log in raw whole milk with UV treatment at a dose of 1.5 kJ/l in the reactor. The higher UV dose used by Reinemann *et al.* (2006) compared to Bandla *et al.* (2012) accounted for the higher level of inactivation of SPC.

Olfactory sensory analysis using the triangle test revealed that there was no significant difference between the odours of UV-treated and untreated bovine milk samples on the treatment day. However, the UV-treated and untreated samples had significantly different odours from the fresh milk on the 1st, 3rd and 7th days of storage at 4°C. Reinemann *et al.* (2006) observed cooked, barny, rancid and unclean off-flavours in UV-treated milk immediately after the UV treatment, at a dose of 1.5 kJ/l indicating that the higher UV dose in milk may induce flavour impairment at a higher

rate. The higher values of malondialdehyde and other reactive substances (MORS) in UV-treated whole milk highlighted that oxidative degradation, particularly the photochemical reactions, caused oxidation of unsaturated fatty acid residues in milk lipids and phospholipids (Koutchma *et al.*, 2009).

The use of nonpasteurized milk is a major food safety concern for cheese manufacturing, so the decontamination capacity of UV light without heat would be a major advantage to the industry. Matak *et al.* (2005) demonstrated that UV radiation could be used to reduce the population of *Listeria monocytogenes* in goat milk. UV radiation (at a dose of $158 \pm 16 \text{ J/m}^2$) of raw goat milk contaminated with 10^7 CFU/ml of *Listeria monocytogenes* reduced the *Listeria* population by 5 log units, suggesting that UV treatment in goat's milk cheese production without heat treatment would be safe. Whey, being heat sensitive, denatures above 68°C and can be UV treated for pasteurization to lower the bacterial load by 5 log without denaturation, and chill brines used in the production of cheese have been irradiated for pasteurization at low temperature (Falguera *et al.*, 2011). The total viable count of bacteria in whey was reduced by 3.5 log using a SurePure turbulent reactor with UV intensity at 450 W/m^2 (Simmons *et al.*, 2012).

Milk and dairy products contain higher numbers of pathogens and spoilage microorganisms compared to fruit juices and, thus, pose a greater challenge for UV treatment. Reductions of 7 log of total bacterial count were achieved in brine, sweet and acid whey, thus indicating the potential use of UV light treatment in whey and brine in dairy processing (Gupta, 2011).

A recent study on the effects of UV processing on the quality parameters of whole milk demonstrated that irradiated milk did not show any significant changes in the pH, viscosity, colour and soluble solid contents. The pH of UV-treated milks was in the range 6.66–6.70; milk viscosity after treatment was, on average, $2.00 \pm .01$ (m Pa s); the soluble solid contents of the treated milks was, on average, 12.78 ± 0.10 (% g/g); and the colour change component ΔE^* of the milks was in the range 0–0.5 when whole pasteurized milks were UV-treated with a treatment dose 10 m J/cm^2 with duration of 12–235 minutes (Orlowska *et al.*, 2012).

Rossitto *et al.* (2012) investigated the feasibility of a continuous turbulent flow UV reactor at 254 nm for extending the shelf life of pasteurized milk by measuring the germicidal capacity of common milk bacteria, including the pathogens and sensory characteristics of milk. Pasteurized milks of 3.5 and 2 % fat contents were UV processed at a flow rate 4000 l/h using two dose levels (880 and 1760 J/l) in a SurePure turbulent reactor unit consisting of four UV lights connected in a series mode (SP-4; SurePure, Milnerton, South Africa). The efficacy of UV radiation on the reduction of the native milk microorganisms was evaluated by storing the treated milks at 4 and 7°C and analysing them weekly for five weeks. The results of all the treated milks showed >5 log reduction of psychrotrophic and mesophilic bacteria, >6 log reduction of aerobic spore formers and 7 log reduction of coliform organisms immediately after the UV treatments. Pathogens and spoilage microorganisms were inactivated only <3 log at a dose level below 880 J/l, while there was no more bacterial reduction at a dose level higher than 1760 J/l, implying that the suitable UV dose ranges are from 1000 to 1600 J/l for milk processing. The sensory analyses data demonstrated that panelists clearly noted sensory defects associated with UV-treated milk after treatment and during storage. The storage data for the microbial inactivation of the UV-treated milks showed lower bacterial counts in comparison to controls in all samples during storage for five weeks at 4 and 7°C .

Control milk was spoiled by seven days at 4°C while all UV-treated milks showed shelf life up to 21 days at 7°C. The research clearly indicated that UV treatment of milk at an appropriate dose with turbulent flow conditions will have a beneficial economic impact by extending the shelf life of milk and, potentially, opening up new dairy markets.

Pioneering work by Australian researchers Christen *et al.* (2013) showed that UV pasteurization of human milk did not cause any alteration in the activity of some heat-labile bioactive components that are completely eliminated during thermal pasteurization. Thus, UV treatment maintains the nutritional value of human milk, demonstrating that UV treatment can be employed as an alternative to pasteurization. UV processing of spiked human milk (380 ml; solids content 10.5–14.5%) with five vegetative bacteria (*Staphylococcus epidermidis*, *Enterobacter cloacae*, *Bacillus cereus*, *Escherichia coli* and *Staphylococcus aureus*) was performed in a basic laboratory set-up comprising a UV lamp placed diagonally in a glass beaker of milk with a magnetic stirrer at 500 rpm for 30 minutes in a batch mode. A 5 log reduction of each bacterium was achieved at UV treatment times of 8.3, 14.8 and 26.5 minutes of human milk (0.381) with total solids concentrations of 10.5, 12.5 and 14.5 %, respectively, under the experimental conditions. A positive correlation between the decimal reduction dosage (J/l) and the total solids content (%) in the human milk was established for prediction of UV treatment time for bacterial inactivation with milk of known solids content using the identical experimental conditions. Bile salt stimulated lipase (BSSL), the bioactive ingredient in human milk, showed no significant change in activity and alkaline phosphatase, a biomarker in thermal pasteurization, also remained intact in UV-treated milk. There was no significant alteration of fatty acid profile up to a high dose level of (4.863 kJ/l) required for a 5 log reduction of vegetative bacteria in human milk containing very high milk solids (14.5%). The fact that UV processing of human milk preserves BSSL will be particularly beneficial for the growth of preterm and term infants as BSSL, which helps in digestion of milk fat in human milk, is available through the UV-treated milk.

Table 7.3 illustrates the UV treatment conditions and bacterial log reductions achieved by UV processing of milk and dairy products.

7.4.3 Packaging and Surface Disinfection

Microbial disinfection of the solid packaging surfaces by means of UV technology is strongly recommended in the dairy industry, as it can enhance the shelf life of dairy products. The application includes reduction of microbial counts on all kinds of packaging used in the dairy industry, including tubs, bottles, cans, lids, covers and foils for yoghurt, milk, butter, cheese and other dairy products. Using UV radiation (continuous) on the solid surfaces with appropriate dose and duration prior to filling with dairy products reduces food spoilage microorganisms, thus lengthening the shelf life of the product and lowering the risk of contamination (Berson UV-Techniek, 2005).

7.5 Commercial Developments

UV technology has been commercialized for water disinfection in breweries and for pasteurization for apple cider in the beverage industry but is not used extensively in

Table 7.3 UV light technology in milk and dairy processing

Source	Microorganism(s) affected	Dose	Log reduction	References
Milk	Total viable bacteria	1.5 kJ/l	3	Burton (1951)
Milk 2% fat content	<i>Cryptosporidium parvuum</i> and <i>E. coli</i> <i>Listeria monocytogenes</i>	158 ± 16 J/m ²	5	Matak <i>et al.</i> (2005)
Raw milk	Standard plate count, psychrotrophic, coliforms, <i>E. coli</i> , and sporeformers	1.5 kJ/l	2–3	Matak <i>et al.</i> (2005)
Semi-skimmed or whole milk	<i>M. avium subsp. paratuberculosis</i> (MAP)	1 kJ/l	0.5–1.0	Reinemann <i>et al.</i> (2006)
Skimmed milk	<i>E. coli</i> 25922	700 J/m ²	3.3	Altic <i>et al.</i> (2007)
Raw whole milk	<i>Bacillus sporothermodurans</i>	1 kJ/l	1–2	Milly <i>et al.</i> (2007)
Raw whole milk	Aerobic bacteria	1.2 kJ/l	3	Surepure (2008)
Raw whole milk	Coliforms	0.6 kJ/l	1	Surepure (2008); Gouws (2008)
Pasteurized skimmed milk	Bacteria spores	1.2 kJ/l	1.5	Choudhary <i>et al.</i> (2011)
Raw whole milk	<i>E. coli</i> W1485	111.87 J/m ²	>7	
Pasteurized skimmed milk	Standard plate count	<i>Bacillus cereus</i>	2.65	
Raw whole milk	Total viable bacteria	0.08 kJ/l	2.7	Bandla <i>et al.</i> (2012)
Model fluid similar to whey	Psychrotrophic and mesophilic bacteria	450 W/m ²	2.3	Simmons <i>et al.</i> (2012)
Pasteurized whole milk and 2% fat milk	Aerobic spore formers	0.88 kJ/l and 1.76 kJ/l	3.5	Rossitto <i>et al.</i> (2012)
Human milk	Coliforms		>5	
	Five vegetative milk bacteria	4.863 kJ/l	>6	
			7	
			5	Christen <i>et al.</i> (2013)

the dairy industry. Although not directly applicable to milk streams, UV systems of different geometric configurations to those which are used in water treatment have the potential to be used for bacterial control and disinfection of whey and water in the dairy industry. UV treatment is successfully used to enable re-use of water for cleaning purposes (Berson UV-Techniek, 2005). Support for this type of application of UV technology has been boosted by FDA regulatory approval of a UV light based disinfectant system for water used in dairy processing, as required by the Pasteurized Milk Ordinance (PMO) in 2009 (FDA, 2011). The UV-treated water provided by the commercial UV system is equivalent to heat-pasteurized water and has exponentially increased the efficiency of filling lines, thus saving money and energy for the United States dairy industry (Dairy Reporter, 2009; WaterWorld, 2009).

UV-treated water has been used by some Australian dairy processors to disinfect water used for cleaning purposes in the industry and for controlling bacteria in the condensate for its re-use. As an example, a Victorian dairy processor in Australia uses UV light to disinfect water used for rinsing of cheese vats for controlling microorganisms in the vats, thus increasing the shelf life of soft cheeses. A South African cheese processor, seeking a nonchemical disinfection system, used UV treatment to disinfect brine used in a feta cheese plant. The processor found that the UV system was simple and easy to install and was effectively able to disinfect brine without use of chemical disinfectant. The cheese produced from the UV-treated brine tank did not have any alteration in the organoleptic qualities after production and during the storage period (Prasad *et al.*, 2011).

7.6 Other Light Processing Technique using UV light

The disadvantages associated with application of continuous UV light (the requirement of a warm-up stage, inefficient power use during off-periods and shortened lamp lifetime) demand an alternative to the continuous lamp systems. This has led to the development of pulsed power based flash lamp systems. Pulsed power is a power magnifying technique that involves accumulating energy over relatively long periods (fractions of a second) and releasing this stored energy over a shorter period (millionths and thousandths of a second). The main feature of the technique is the rapid release of energy from the energy store that multiplies the power many fold. The same principle is used in pulsed light (PL) technology, which involves the use of high intensity pulsed broad spectrum light that flashes several times per second (typically 1–20 flashes per second) to destroy microbes on the surfaces of dairy and other food products, food contact materials and medical devices and in liquid foods with significant rapidity and effectiveness. The decontamination capacity of PL was found to be 2.4 times more effective than continuous UV irradiation (Palgan *et al.*, 2011). PL technology has been used in the food industry for decontamination purposes after FDA approval in 1996. The regulatory conditions of PL technology for use in commercial food applications involve the use of a xenon lamp for emission of broad spectrum light at 200–1000 nm, with a pulse duration not exceeding 2 ms and the total treatment energy not exceeding 12 J/cm² (FDA, 2000). Commercial units are manufactured by PurePulse Technologies, Inc. (San Diego USA) and Wek-Tec

(Heilbronn, Germany). Box 7.3 illustrates the advantages of PL technology applied in food and dairy products.

Box 7.3 Advantages of PL technology applied in food and dairy products

- Can provide pasteurization without heating the product in very short treatment times (less than 5 seconds) (Demirci and Panico, 2008)
- A higher average power (3.5 MW) is produced by PL treatment for short duration (100 ns) compared to average power generated by continuous UV light treatment (100 W) (Rowan *et al.*, 1999)
- Surface and air disinfection can be achieved (Pereira and Vicente, 2010)
- Microbes exposed to PL do not exhibit any tailing in the survival curves (Dunn *et al.*, 1995), indicating no innate capacity for resistance in microbial populations, unlike other inactivation mechanisms
- PL is used for sterilizing films of packaging material (Dunn *et al.*, 1995)
- Xenon flash lamp used in PL is more environmentally friendly than mercury lamps used in UV (Gómez-López *et al.*, 2007)
- Limited oxidation reactions after PL treatment due to short pulse duration (Krishnamurthy *et al.*, 2007)
- Microorganism killing effect has been shown even in the absence of UV light component (Dunn *et al.*, 1995; Wekhof, 2003)

7.7 Basic Principle of PL Technology

PL is produced using a pulsed power energizing technique (PPET) that augments power many times by conversion of high speed electron pulses into intense broad spectrum light energy that exists for 100 ns to 2 ms in the form of pulses. A PL unit comprises three main components: a high voltage power supply, the pulse forming network as PPET and the flash lamp, which is filled with inert xenon gas. A high voltage electrical pulse is applied to xenon gas in the flash lamp causing the gas to be ionized and plasma to be formed, resulting in the generation of a very large current. The high current pulse is further sent through the ionized xenon gas when the electrons of the ionized gas jump to higher energy levels. The pulsed light is emitted when the excited electrons release their energy by jumping from a higher to a lower energy level, thereby forming photons. A light pulse output with an average electrical power output of 3.5 MW can be obtained for 85 ns (Rowan *et al.*, 1999). The wavelength distribution of PL ranges from 180 to 1100 nm, including UV (180–380 nm), visible light (380–700 nm) and infrared (700–1100 nm). PL is 20 000 times more intense than sunlight and is able to destroy microorganisms (Krishnamurthy *et al.*, 2008). The PL treatment dose is quantified by ‘fluence’, which is total radiant energy of PL exposure on the food surface and the intensity is measured in J/cm²; the PL energy is determined by actinometry (Moraru, 2011). Commercial PL units for use in food processing are available in both batch and continuous treatments. for elimination of microbes.

7.8 Effects of PL on Microorganisms

7.8.1 Mechanisms of Action

The most striking feature of PL is its capacity to deliver intense energy in the form of several pulses for killing microorganisms with remarkable rapidity and effectiveness. Similar to UV light, inactivation of microorganisms is achieved by formation of dimers resulting in distortion of the helix in microbial DNA. The lethal effect is also due to the photochemical effect of the UV light. Additionally, PL generates photothermal and photophysical effects causing rupture of the cell wall and membrane, which results in leakage of cytoplasm with eventual cell death (Miller *et al.*, 2012). The photothermal effects are based on the instantaneous heat generation inside the product due to the higher energy of PL and inactivation of bacteria due to UV absorption. Interestingly, the instantaneous heat produced by the photothermal reactions does not raise the temperature of the exposed sample. The photophysical effect occurs due to rapid release of intense energy in PL treatment. The photothermal efficiency of inactivation of microorganisms using PL can be illustrated by the observation that *Aspergillus niger* spores were not totally inactivated using UV light with a dose of 10–30 kJ/cm² whereas they were destroyed totally using PL of 50–60 kJ/cm² with the photothermal effect (Marquenie *et al.*, 2003).

The mechanism for inactivation of microorganisms using PL is based on the combined effects of UV light and photothermal reactions (Oms-Oliu *et al.*, 2010); however, the microbial killing has been demonstrated to occur even in the absence of UV light (J.E. Dunn, Private communication with W.J. Kowalski, unpublished test results). The decontamination doses of PL treatment are an order of magnitude lower than that of UV light treatment required to achieve the same degree of disinfection, indicating that energy is delivered more efficiently by PL treatment (Rowan *et al.*, 1999; Dunn, 2000). An interesting feature of PL treatment has been demonstrated by the absence of tailing in the survival curves of the bacteria exposed to PL radiation, highlighting that exposed bacteria do not develop resistance to PL during treatment.

Unlike UV treatment, microorganisms in PL-treated food products do not show any enzymatic repair mechanisms highlighting the potential applications of PL treatment in food and dairy processing. Thus, the innate repair mechanisms of microorganisms may not be effective in reversing the large amounts of damage incurred during PL treatment.

In contrast to UV light treatment, PL treatment can effectively limit oxidation reactions because of the short pulse duration (typically 300 ns to 1 ms) and the half-life of π -bonds (1029–1024 s), resulting in the hindrance of coupling with dissolved or free oxygen (Fine and Gervais, 2004). These phenomena indicate that PL treatment of milk and dairy products may not induce oxidative reactions and will, therefore, not produce any detrimental effects on milk components (Krishnamurthy *et al.*, 2007).

7.8.2 Inactivation of Bacteria in Liquid and Dairy Products

Takeshita *et al.* (2003) compared the biological parameters inducing inactivation of *Saccharomyces cerevisiae* after treatment with PL and UV light. Higher inactivation efficiency of yeast cells using PL treatment with only three pulses was observed by detecting expanded vacuoles and distorted membranes in 50% of treated cells and more protein leaching out from the leaky yeast cells. In contrast, there was no presence

of expanded vacuoles and altered membranes in the UV treated cells; however, a minor quantity of eluted protein was present.

Dunn *et al.* (1991) demonstrated that PL treatment (fluence of 16 J/cm² and a pulse duration of 0.5 ms) of curds of commercially dried cottage cheese inoculated with *Pseudomonas* spp. resulted in a 1.5 log reduction of the microbial population after two pulses. The surface temperature of the curd increased by 5°C. Sensory evaluation with trained panelists showed promising results without any effects of the treatment on the organoleptic taste of the cheese, suggesting the potential use of PL treatment of cheese curds for improvement of cottage cheese shelf life by lowering the count of *Pseudomonas* spp.

A pilot study by Smith *et al.* (2002) investigated the inactivation of mesophilic aerobic bacteria in bulk tank milk with PL treatment by exposing 1 ml of milk to pulsed energy at 25 J/cm². PL treatment resulted in the complete elimination of the mesophilic bacteria in bulk tank milk, as shown by the inability to recover viable bacteria (no growth for any of the plated or subcultured samples even after incubation for 21 days) from treated samples. These data indicated that the bacterial content of raw milk can be adequately controlled using PL treatment. This treatment could be applied on-farm (similar to thermization) to reduce the growth of spoilage bacteria and, consequently, may reduce the gelation problem in UHT milk and bitter and rancid flavours in UHT and extended shelf life (ESL) milks.

The inactivation efficiency of PL treatment for *Staphylococcus aureus* in milk in a continuous mode was investigated by Krishnamurthy *et al.* (2007) in a parametric study. The effects of parameters such as distance of milk sample from the PL source (5–11 cm), number of passes (1–3 passes) and flow rate of milk (20–40 ml/min) for PL treatment using three pulses per second and an exposed energy at 1.27 J/cm on milk samples per pulse were studied. The results of PL-treated milk showed the log reduction ranged from 0.55 to 7.26 log and complete inactivation of *S. aureus* was achieved on two occasions at (i) an 8-cm sample distance from the PL source with a single pass and 20 ml/min flow rate, and (ii) an 11-cm sample distance from the source with two passes and 20 ml/min flow rate combinations (Krishnamurthy *et al.*, 2007). The milk sample distance from the energy source was the only statistically significant variable that showed the highest inactivation which caused absorption of maximum energy in the PL-treated milk.

The work of Choi *et al.* (2010) to determine the commercial feasibility of PL treatment of infant formula as an alternative to conventional pasteurization was the first attempt to use PL treatment on this food. The batch mode of PL treatment was used at 10–25 kV of voltage pulse on 2 mm thick infant foods, including an infant beverage, an infant meal and an infant milk powder containing 10⁵ CFU/g of *Listeria monocytogenes* with the sample surface 60 mm away from the xenon lamp. *L. monocytogenes* grown on tryptic soy agar (TSA) plates was also used for inactivation purposes to determine the effects of viscosity and opaqueness of the medium on inactivation efficiency of PL treatment. About 4–5 log reductions of *L. monocytogenes* were achieved (on TSA plates) with PL treatment for 5000, 600, 300 and 100 µs at 10, 15, 20 and 25 kV of voltage pulse, respectively (Choi *et al.*, 2010). The results demonstrated that complete killing of *L. monocytogenes* on agar plates was possible using PL treatment for 100 µs at 25 kV of voltage pulse. The inactivation of *L. monocytogenes* of infant formula by PL treatment was increased exponentially with the treatment period. The greatest cell inactivation was achieved in the infant beverage due to its low viscosity and turbidity compared to the infant meal and infant milk powder. 1 and 5

log-reductions with 630 and 3500 μs of PL treatment in the infant beverage, 1 and 3 log reductions with 900 and 4800 μs of treatment in infant meal and 1, 2 and 3 log reductions with 2300, 4700 and 9500 μs of treatment in infant milk powder, respectively, using 15 kV voltage pulse were observed. Similarly, a 5 log reduction of *Enterobacter sakazakii* in an infant beverage, infant meal and powdered infant milk was achieved with pulsed light treatment at 10 and 15 kV, after 4.6 and 1.8 ms, respectively. An exponential inactivation of the bacteria was observed at 15 kV treatment as a function of time (Choi *et al.*, 2009). These data suggest the potential for the commercial application of PL treatment for the pasteurization of pastes in the dairy industry. Artíguez *et al.* (2011) studied the impact of various operating parameters (voltage input, flow rate, liquid thickness, number of pulses and total fluence) on inactivation of *Listeria innocua* continuous flow of water in the PL reactor. The rate of inactivation of *L. innocua* increased with an increase in the number of pulses and with total fluence using a continuous PL unit; the reduction of *L. innocua* took place at minimum light pulse treating water in a thin layer in the continuous PL unit caused an adequate exposure of microorganisms to incident light, thereby improving the effectiveness of PL.

The total fluence of 10 J/cm² used in the PL treatment caused more than a 5 log reduction of *L. innocua* without increasing the water temperature. The results indicated that liquid treatment in a continuous flow PL unit could be potentially adapted to an industrial setting and PL technology could be useful as an alternative to pasteurization.

To determine the efficacy of PL treatment as an alternative to thermal pasteurization, the decontamination of raw milk was investigated by Miller *et al.* (2012) by assessing the inactivation of *Escherichia coli*. The effectiveness of the PL treatment was established by evaluating the effects of total solids and fat content of milk on inactivation of the bacteria. One millilitre of milk inoculated with 10⁷ CFU of *E. coli* was exposed to PL treatment with total energy doses of 2.14–14.9 J/cm² under static and turbulent conditions. Fluence higher than the recommended FDA dose (12 J/cm²) was used in the PL treatment (up to 14.9 J/cm²) to determine whether a plateau in the *E. coli* inactivation curve was achieved during the PL treatment. Increasing fluence led to increased reduction levels of *E. coli* in PL treatment; however, no sign of a plateau was observed in the *E. coli* inactivation curve. The total solids contents of milk used was 9.8%, 25% and 45% and variable fat contents in the form of skimmed milk (2% fat) and whole milk (4% fat) were used in the PL trials. The PL exposure in contaminated raw milks resulted in reduction levels of 3.4 log of the *E. coli* population in the skimmed milk and a greater than 2.5 log reduction of the bacterial population in both skimmed milk and whole milk after treatment with PL at 14.9 J/cm² under turbulent conditions. A 2.5 log reduction of *E. coli* in milk with 9.8% solids and a less than 1 log reduction of bacterial cells in the concentrated milks (25 and 45% solids content) resulted after PL treatment with 8.4 J/cm² in turbulent mode, while PL treatment of concentrated milks in static mode was ineffective. These data indicate that PL treatment is only effective for the decontamination of *E. coli* in milk in turbulent conditions, with limited effectiveness for microbial destruction in concentrated milk, due to the absorption of PL and shielding of the bacteria by the milk solids. The light scattering effects of milk fat also reduced the effectiveness of PL treatment.

Fernández *et al.* (2012) evaluated the impact of PL technology on the surface properties of whey protein by treating β -lactoglobulin solutions (protein concentration 0.5–10 mg/ml) at the dose level of total fluence of 4 J/cm² in a PL reactor of batch configuration. PL treatment caused the partial denaturation of the whey proteins by

damaging the secondary and tertiary structure, with exposure of the core hydrophobic groups. This occurred without significant increase of temperature resulting in higher protein adsorption at the air–water interface. Thus, the conformational change in protein structure produced a significant increase in the viscosity of the protein layer in the air–water interface, which eventually led to higher foaming stability. The results suggested that PL-treated whey proteins would be useful for improving foaming capacity as functional ingredients in the dairy industry.

7.9 Commercial Developments

There has been general interest in PL technology by the dairy industry due to its remarkable rapidity and effectiveness in destroying microorganisms. However, to date there is no commercial PL unit installation in use by the dairy industry. There are a number of commercial applications in packaging lines for the food and pharmaceutical industries. The French company Claranor (Manosque, France) has developed a range of PL equipment for the food and beverage industries, including in-line sterilization units for caps, pre-formed packaging, films, or jars since 2004. A PL reactor for in-line disinfection of clear liquids and water using PL technology has also developed by the same company (<http://claranor.com/>). PL-treated caps, closures and yogurt pots before filling showed efficient sterilization, replacing gamma irradiation or chemical disinfectant in the dairy industry. In 2010, a European beverage company first installed a PL unit for decontamination of sugar syrup; this was able to remove *Alicyclobacillus acidoterrestris*, a heat-resistant spore-former, without altering the sensory and chemical properties of sugar syrup (Watson, 2010). Similar applications of PL treatment with clearer liquids, in comparison to milk, like whey and brine, in the dairy industry have been proposed (Harrington, 2011).

7.10 Conclusions

Research on UV technology and the advent of modern process equipment have led to the development of novel UV systems where turbulent flow and uniform mixing of the subjected fluid in the UV reactor bring better penetration of UV light into the fluid, thus leading to greater levels of microbial disinfection in the UV radiated fluid. Although UV technology has been commercially used in water treatment and the beverage industry, it has yet to be widely adopted in the dairy industry. Potential applications of UV technology in the dairy industry include: reduction of on-farm spoilage in high bacterial content milk; treatment of milk fed to calves to lower the risk of infectious disease; reduction of bacteria not susceptible to thermal treatment; and reduction of psychrotrophic bacteria in refrigerated milk stored for extended periods. Currently, dairy processors all over the world are using UV technology for disinfection of bacteria in the water treatment plant for recirculation purposes. The main reasons for lack of exploitation of UV technology in milk stream processing are: low penetration of UV light into milk; flavour impairment in milk; inability of UV light to completely eliminate bacterial spores, resistance of some pathogens, for example MAP to UV light; and, nonavailability of an indicator and reliable testing method for UV pasteurization efficiency (such as alkaline phosphatase tests in thermally pasteurized milk). Further research in these areas will help develop UV technology into a cost effective and potentially viable alternative to thermal pasteurization for the dairy industry.

Microbial inactivation experiments have demonstrated that PL treatment is a promising alternative to traditional low powered UV light processing of low transparent and opaque liquids like milk. However, to our knowledge, there is no commercial PL unit available for the dairy industry. Research on PL treatment has gained popularity recently but this novel technology has not yet been fully explored and remains one of the least investigated emerging nonthermal technologies. Microbial inactivation mechanisms and inactivation kinetics of major pathogens in milk and cheese matrices employing PL treatment have not yet been established. Further study on these areas is of utmost important for evaluation of PL technology in terms of the safety and quality parameters of dairy systems. In-depth research is required for understanding/acquiring a comprehensive knowledge of the optical and UV light absorbing properties of the major milk components and the interactions of milk components with UV light and PL in order to exploit the full potential of both technologies in the dairy industry. The effects of both UV light and PL on enzymes commonly present in milk, such as proteases, lipases, alkaline phosphatases, lactoperoxidases and lysozymes, and the coagulation properties of UV light and PL-treated milks during gel formation in yogurt and cheese making, need to be established to determine the full advantages of these novel techniques before recommending them to the dairy industry.

Requisite scientific parameters for establishing the pasteurization efficacies in milk and other dairy products using novel technologies are required to determine the application of these innovative technologies as adjuncts or replacements in dairy processing. This requires collaboration between international bodies, including the United Nations Food and Agriculture Organization (FAO) and the Codex Alimentarius to achieve the full potential of these technologies in dairy systems.

Acknowledgements

The authors gratefully acknowledge Mrs Nuwan Vithanage and Mrs Jeevana Bhongir for their assistance in the preparation of the chapter, particularly for their contributions to EndNote referencing and editing.

References

- Altic, L.C., Rowe, M.T. and Grant, I.R. (2007) UV light inactivation of *Mycobacterium avium subsp. paratuberculosis* in milk as assessed by FASTPlaqueTB phage assay and culture, *Applied and Environmental Microbiology*, **73**: 3728–3733.
- Artíguez, M.L., Lasagabaster, A. and Marañón, I.M.d. (2011) Factors affecting microbial inactivation by Pulsed Light in a continuous flow-through unit for liquid products treatment, *Procedia Food Science*, **1**: 786–791.
- Bandla, S., Choudhary, R., Watson, D.G. and Haddock, J. (2012) UV-C treatment of soymilk in coiled tube UV reactors for inactivation of *Escherichia coli* W1485 and *Bacillus cereus* endospores, *LWT – Food Science and Technology*, **46**: 71–76.
- Berson UV-Techniek (2005) UV disinfection in the dairy industry, Food processing .com.au. <http://www.foodprocessing.com.au/articles/158-UV-disinfection-in-the-dairy-industry>. Accessed February 02, 2013.

- Bolton, J. and Linden, K. (2003) Standardization of methods for fluence (UV dose) determination in bench-scale UV experiments, *Journal of Environmental Engineering*, **129**(3), 209–215.
- Burton, H. (1951) Ultraviolet irradiation of milk. , *Dairy Science Abstracts.*, **13**: 229–224.
- Chang, J.C., Ossoff, S.F., Lobe, D.C. *et al.* (1985) UV inactivation of pathogenic and indicator microorganisms, *Applied and Environmental Microbiology*, **49**: 1361–1365.
- Choi, M.-S., Chan-Ick, C., Eun-Ae, J. *et al.* (2009) Inactivation of *Enterobacter sakazakii* inoculated on formulated infant foods by intense pulsed light treatment, *Food Science and Biotechnology*, **18**: 1537–1540.
- Choi, M.-S., Cheigh, C.-I., Jeong, E.-A. *et al.* (2010) Nonthermal sterilization of *Listeria monocytogenes* in infant foods by intense pulsed-light treatment, *Journal of Food Engineering*, **97**: 504–509.
- Choudhary, R. and Bandla, S. (2012) Ultraviolet pasteurization for food industry, *International Journal of Food Science and Nutrition Engineering*, **2**: 12–15.
- Choudhary, R., Bandla, S., Watson, D.G. *et al.* (2011) Performance of coiled tube ultraviolet reactors to inactivate *Escherichia coli* W1485 and *Bacillus cereus* endospores in raw cow milk and commercially processed skimmed cow milk, *Journal of Food Engineering*, **107**: 14–20.
- Christen, L., Lai, C.T., Hartmann, B. *et al.* (2013) Ultraviolet-C irradiation: A novel pasteurization method for donor human milk, *PLoS One*, **8**: e68120.
- Dairy Reporter (2009) UV alternative to heat pasteurisation gains US approval. <http://www.dairyreporter.com/Regulation-Safety/UV-alternative-to-heat-pasteurisation-gains-US-approval> (last accessed 5 January 2015).
- Dean, W.R. (1927) Motion of fluid in a curved pipe. *Philosophical Magazine and Journal of Science*, **4**, 15–20.
- Deeth, H.C., Datta, N. and Versteeg, C. (2013) Nonthermal technologies in dairy processing. In *Advances in Dairy Ingredients* (eds G.W. Smithers and M.A. Augustin). John Wiley & Sons, Inc, Hoboken, NJ, pp. 161–215.
- Demirci, A. and Panico, L. (2008) Pulsed ultraviolet light, *Food Science and Technology International*, **14**: 443–446.
- Donaghy, J., Keyser, M., Johnston, J. *et al.* (2009) Inactivation of *Mycobacterium avium* ssp. *paratuberculosis* in milk by UV treatment, *Letters in Applied Microbiology*, **49**: 217–221.
- Dunn, J.E., Clark, W.R., Asmus, J.F. *et al.* (1991) *Methods for preservation of foodstuffs*. Maxwell Laboratories, Inc, San Diego, CA.
- Dunn, J., Ott, T. and Clark, W. (1995) Pulsed-light treatment of food and packaging, *Food Technology*, **49**: 95–98.
- Dunn, J. (2000) Pulsed-light disinfection of water and sterilization of blow/fill/seal manufactured aseptic pharmaceutical products. In *Disinfection, Sterilization, and Preservation* (ed. S.S. Block). Lippincott Williams and Wilkins, USA.
- Engin, B. and Karagul, Y.Y. (2012) Effects of ultraviolet light and ultrasound on microbial quality and aroma-active components of milk, *Journal of the Science of Food and Agriculture*, **92**: 1245–1252.
- Falguera, V., Pagán, J., Garza, S. *et al.* (2011) Ultraviolet processing of liquid food: A review, *Food Research International*, **44**: 1580–1588.
- FAO (2012) OECD-FAO Agricultural Outlook 2012-2021. Retrieved from http://www.fao.org/fileadmin/templates/est/COMM_MARKETS_MONITORING/Oilcrops/Documents/OECD_Reports/Ch5StatAnnex.pdf (last accessed 5 January 2015).

- FAO (2013) Food Outlook: Biannual Report on Global Food Markets. <http://www.fao.org/docrep/019/i3473e/i3473e.pdf> (last accessed 5 January 2015).
- FDA (Food and Drug Administration) (2000) 21 CFR Part 179. Irradiation in the production, processing and handling of food, *Federal Register*, **65**: 71056–71058.
- FDA (Food and Drug Administration) (2003) Guidance for industry: the juice HACCP regulation – questions and answers. <http://www.fda.gov/food/guidanceregulation/guidancedocumentsregulatoryinformation/ucm072602.htm> (last accessed 5 January 2015).
- FDA (Food and Drug Administration) (2009) Grade “A” Pasteurized Milk Ordinance; 2009 Revision. <http://www.fda.gov/downloads/food/guidanceregulation/ucm209789.pdf> (last accessed 5 January 2015).
- FDA (Food and Drug Administration) (2011). Grade “A” Pasteurized Milk Ordinance; 2011 Revision. <http://www.fda.gov/downloads/food/guidanceregulation/ucm291757.pdf> (last accessed 5 January 2015).
- Fernández, E., Artiguez, M.L., Martínez de Marañón, I. *et al.* (2012) Effect of pulsed-light processing on the surface and foaming properties of β -lactoglobulin, *Food Hydrocolloids*, **27**: 154–160.
- Fine, F. and Gervais, P. (2004) Efficiency of pulsed UV light for microbial decontamination of food powders, *Journal of Food Protection*, **67**: 787–792.
- Gailunas, K.M. (2003) Use of ultraviolet light for the inactivation of *Listeria monocytogenes* and lactic acid bacteria species in recycled chill brines. MSc Thesis, Virginia Polytechnic Institute and State University, USA.
- Gómez-López, V.M., Ragaert, P., Debevere, J. and Devlieghere, F. (2007) Pulsed light for food decontamination: a review, *Trends in Food Science & Technology*, **18**: 464–473.
- Gómez-López, V.M., Koutchma, T. and Linden, K. (2012) Ultraviolet and pulsed light processing of fluid foods. In *Novel Thermal and Non-Thermal Technologies for Fluid Foods* (eds P.J. Cullen, B. Tiwari and V. Valdramidis). Academic Press, San Diego, CA, pp. 185–223.
- Gouws, P. (2008) Survival and elimination of pathogenic, heat resistant and other relevant microorganisms treated with UV. Food Microbiology Research Group, Department of Biotechnology, University of the Western Cape, South Africa.
- Guerrero-Beltrán, J.A. and Barbosa-Cánovas, G.V. (2004) Advantages and limitations on processing foods by UV light, *Food Science and Technology International*, **10**: 137–147.
- Guneser, O. and Karagul Yuceer, Y. (2012) Effect of ultraviolet light on water- and fat-soluble vitamins in cow and goat milk, *Journal of Dairy Science* **95**: 6230–6241.
- Gupta, S. (2011) Milk goes ultraviolet, *New Scientist*, **210**: 19.
- Harrington, R. (2011) Pulsed light poised for wider industry adoption. *FoodProduction Daily* (<http://www.foodproductiondaily.com/Safety-Regulation/Pulsed-light-poised-for-wider-industry-adoption>; last accessed 5 January 2015).
- Hembry, O. (2008) Fonterra health drink thrives under pressure, *The New Zealand Herald* [online] (http://www.nzherald.co.nz/business/news/article.cfm?c_id=3&objectid=10521364; last accessed 28 January 2015).
- Higgins, K.T. (2001) Fresh today safe next week, *Food Engineering*, **73**, 44–49.
- Jay, J.M. (1995) Radiation preservation of foods and nature of microbial radiation resistance. In *Modern Food Microbiology* (ed. J.M. May). Springer New York, pp. 304–327.
- Josset, S., Taranto, J., Keller, V. *et al.* (2007) UV-A photocatalytic treatment of high flow rate air contaminated with *Legionella pneumophila*, *Catalysis Today*, **129**: 215–222.

- Keyser, M., Müller, I.A., Cilliers, F.P. *et al.* (2008) Ultraviolet radiation as a non-thermal treatment for the inactivation of microorganisms in fruit juice, *Innovative Food Science & Emerging Technologies*, **9**: 348–354.
- Koutchma, T. (2009) Advances in ultraviolet light technology for non-thermal processing of liquid foods, *Food and Bioprocess Technology*, **2**: 138–155.
- Koutchma, T., Parisi, B. and Patazca, E. (2007) Validation of UV coiled tube reactor for fresh juices, *Journal of Environmental Engineering and Science*, **6**: 319–328.
- Koutchma, T., Forney, L.J. and Moraru, C.I. (2009) UV processing effects on quality of foods. In *Ultraviolet Light in Food Technology: Principles and Applications* (eds T. Koutchma, L.J. Forney, J. and C.I. Moraru). CRC Press, Boca Raton, FL, pp. 103–123.
- Krishnamurthy, K., Demirci, A. and Irudayaraj, J.M. (2007) Inactivation of *Staphylococcus aureus* in milk using flow-through pulsed UV-light treatment system, *Journal of Food Science*, **72**: M233-M239.
- Krishnamurthy, K., Demirci, A. and Irudayaraj, J. (2008) Inactivation of *Staphylococcus aureus* in milk and milk foam by pulsed UV-light treatment and surface response modelling, *Transactions of the ASABE*, **51**: 2083–2090.
- Marquenie, D., Geeraerd, A.H., Lammertyn, J. *et al.* (2003) Combinations of pulsed white light and UV-C or mild heat treatment to inactivate conidia of *Botrytis cinerea* and *Monilia fructigena*, *International Journal of Food Microbiology*, **85**: 185–196.
- Matak, K.E., Churey, J.J., Worobo, R.W. *et al.* (2005) Efficacy of UV light for the reduction of *Listeria monocytogenes* in goat's milk, *Journal of Food Protection*, **68**: 2212–2216.
- Miller, B.M., Sauer, A. and Moraru, C.I. (2012) Inactivation of *Escherichia coli* in milk and concentrated milk using pulsed-light treatment, *Journal of Dairy Science*, **95**: 5597–5603.
- Milly, P.J., Toledo, R.T., Chen, J. and Kazem, B. (2007) Hydrodynamic cavitation to improve bulk fluid to surface mass transfer in a nonimmersed ultraviolet system for minimal processing of opaque and transparent fluid foods, *Journal of Food Science*, **72**: M407-M413.
- Moraru, C.I. (2011) High-intensity pulsed light food processing. In *Alternatives to Conventional Food Processing* (ed. A. Procter). The Royal Society of Chemistry, Cambridge, UK, pp. 367–386.
- Morgan, R. (1989) UV: 'green' light disinfection, *Dairy Industry International*, **54**: 33–35.
- Oms-Oliu, G., Martín-Belloso, O. and Soliva-Fortuny, R. (2010) Pulsed light treatments for food preservation. A review, *Food and Bioprocess Technology*, **3**: 13–23.
- Orlowska, M., Koutchma, T., Grapperhaus, M. *et al.* (2012) Continuous and pulsed ultraviolet light for nonthermal treatment of liquid foods. Part 1: effects on quality of fructose solution, apple juice, and milk, *Food and Bioprocess Technology*, **6**: 1580–1592.
- Palgan, I., Caminiti, I.M., Munoz, A. *et al.* (2011) Effectiveness of high intensity light pulses (HILP) treatments for the control of *Escherichia coli* and *Listeria innocua* in apple juice, orange juice and milk, *Food Microbiology*, **28**: 14–20.
- Pereira, R.N. and Vicente, A.A. (2010) Environmental impact of novel thermal and non-thermal technologies in food processing, *Food Research International*, **43**: 1936–1943.
- Philips (2006) Ultraviolet purification and application information (Lighting Brochure). Philips Lighting, The Netherlands, p. 18 (www.philips.com/uvpurification; last accessed 28 January 2015).
- Prasad, P., Pagan, R., Kauter, M. and Price, N. (2011) Eco-efficiency for the dairy processing industry. In *Sustainable Business* (ed. P. Crittenden). Dairy Australia, Dairy Processing

- Engineering Centre and UNEP Working Group for Cleaner Production, Sydney, Australia, pp. 124–125.
- Reinemann D.J., Gouws, P., Chillier T *et al.* (2006) *New methods of UV treatment of milk for improved food safety and product quality*. Annual International Meeting, American Society of Agricultural and Biological Engineers (ASABE), St Joseph, MI, Paper Number: 066088, pp. 1–9.
- Rowan, N.J., MacGregor, S.J., Anderson, J.G. *et al.* (1999) Pulsed-light inactivation of food-related microorganisms, *Applied and Environmental Microbiology*, **65**: 1312–1315.
- Rossitto, P.V., Cullor, J.S., Crook, J. *et al.* (2012) Effects of UV irradiation in a continuous turbulent flow UV reactor on microbiological and sensory characteristics of cow's milk, *Journal of Food Protection*, **75**: 2197–2207.
- Sastry, S.K., Datta, A.K. and Worobo, R.W. (2000) Ultraviolet light, *Journal of Food Safety*, **65**: 90–92.
- Scheidegger, D., Pecora, R.P., Radici, P.M. and Kivatinitz, S.C. (2010) Protein oxidative changes in whole and skim milk after ultraviolet or fluorescent light exposure, *Journal of Dairy Science*, **93**: 5101–5109.
- Shama, G. (1999) Ultraviolet light. In *Encyclopedia of Food Microbiology* (ed. K.R. Richard). Elsevier, Oxford, pp. 2208–2214.
- Schmidt, S. and Kauling, J., (2007) Process and laboratory scale UV inactivation of viruses and bacteria using an innovative coiled tube reactor, *Chemical Engineering and Technology* **30** (7): 945–950.
- Setlow, P. (2001) Resistance of spores of *Bacillus* species to ultraviolet light, *Environmental and Molecular Mutagenesis*, **38**: 97–104.
- Simmons, M.J.H., Alberini, F., Tsoiligkas, A.N. *et al.* (2012) Development of a hydrodynamic model for the UV-C treatment of turbid food fluids in a novel 'SurePure turbulator™' swirl-tube reactor, *Innovative Food Science & Emerging Technologies*, **14**: 122–134.
- Smith, W.L., Lagunas-Solar, M.C. and Cullor, J.S. (2002) Use of pulsed ultraviolet laser light for the cold pasteurization of bovine milk, *Journal of Food Protection*, **65**: 1480–1482.
- Surepure (2008) *Bacillus sporothermodurans* milk trials. SurePure, Newlands, South Africa (<http://www.surepureinc.com/>; last accessed 5 January 2015).
- Takeshita, K., Shibato, J., Sameshima, T. *et al.* (2003) Damage of yeast cells induced by pulsed light irradiation, *International Journal of Food Microbiology*, **85**: 151–158.
- Tran, M.T.T. and Farid, M. (2004) Ultraviolet treatment of orange juice, *Innovative Food Science & Emerging Technologies*, **5**: 495–502.
- WaterWorld (2009) Atlantium™'s UV system provides U.S. dairy processors with equivalent to heat-pasteurized water. <http://www.waterworld.com/articles/2009/10/atlantium-s-uv-system.html> (last accessed 4 January 2015).
- Watson, E. (2010) Pulsed light in bid to revolutionise soft drink production, Food Manufacture.co.UK (<http://www.foodmanufacture.co.uk/Packaging/Pulsed-light-in-bid-to-revolutionise-soft-drinks-production> (last accessed 5 January 2015).
- Webster, J.B., Duncan, S.E., Marcy, J.E. and O'Keefe, S.F. (2011) Effect of narrow wavelength bands of light on the production of volatile and aroma-active compounds in ultra-high temperature treated milk, *International Dairy Journal*, **21**: 305–311.
- Wekhof, A. (2003) Sterilization of packaged pharmaceutical solutions, packaging and surgical tools with pulsed UV light. Paper presented at Second International Congress on UV Technologies, 9–11 July. Vienna.

8

Carbon Dioxide: An Alternative Processing Method for Milk

Laetitia M. Bonnaillie and Peggy M. Tomasula

Dairy and Functional Foods Research Unit, United States Department of Agriculture/Agricultural Research Service/Eastern Regional Research Center, USA

8.1 Introduction

The typical refrigerated fluid milk shelf life for milk pasteurized at high temperature for a short time (HTST, typically 72°C for 15 s) in the United States is about 14 days. The shelf life is typically limited by the growth of heat-resistant psychrotrophic bacteria and the off-flavours they produce. Higher pasteurization temperatures and longer heating times (e.g. 78°C for 16–30 s) can increase the microbial kill, and better filling and packaging technologies can reduce post-pasteurization contamination, to lengthen the refrigerated shelf life of HTST milk to up to 25 days (Barbano *et al.*, 2006). In milk with extended shelf life, the predominant cause of spoilage is the proliferation of Gram-positive spore-forming bacteria after more than 17 days in refrigerated storage (Fromm and Boor, 2004). Fluid milk processors would like to achieve 60–90 days of refrigerated shelf life for HTST milk, to allow the more efficient marketing and distribution of the product (Barbano *et al.*, 2006).

Besides high and low temperature (pasteurization, and refrigeration or freezing), there are more than 60 other types of hurdles to choose from in order to eliminate or control microbial growth in food products, to preserve the organoleptic and nutritional qualities of a food, and extend shelf life while preventing spoilage and food poisoning (Leistner, 2000). Some of the most popular hurdles for food preservation (after temperature) include changes in acidity (pH), reductions of water activity (a_w) and the addition of preservatives (nitrite, sorbate, sulfite etc.) or competitive microorganisms (e.g. lactic acid bacteria). Hurdles disturb the homeostasis of microorganisms through different mechanisms affecting different aspects of the microbes' physiological responses, for example causing metabolic exhaustion or stress reactions and so

on (Leistner, 2000). For each type of food product, the right combination of hurdles with the right intensities can ensure all pathogens are eliminated or rendered harmless, while at the same time addressing economic viability and consumer preferences.

Carbon dioxide (CO₂) is an alternative hurdle technology that can kill microorganisms or prevent growth and spoilage to extend the shelf life of foods. High-pressure carbon dioxide (HPCD) is an attractive method to treat thermally sensitive foods because it is effective at low or moderate temperatures and preserves much of the organoleptic qualities and functionality of the food; whereas pasteurization may cause a range of undesirable texture and flavour changes in processed fluid milk (Werner and Hotchkiss, 2006). Particularly, raw milk treated with CO₂ instead of HTST, and carbonated raw milk with an extended shelf life, could potentially generate a broader range of cheeses than are currently feasible in the United States and open up new markets for the dairy industry (Werner and Hotchkiss, 2006).

Since the turn of the twentieth century, investigations on the effectiveness of CO₂ as a singular hurdle in milk have shown good antimicrobial properties at high pressures. For example, the treatment of raw milk at 50 atmospheres of CO₂, followed by storage at room temperature under 10 atmospheres of CO₂ stunted the native microbial growth enough to prevent curdling for more than 72 hours, while untreated milk curdled within 24 hours (Hoffman, 1906).

The effectiveness of CO₂ as an antimicrobial hurdle can be synergistically enhanced when combined with certain other preservation hurdles, such as raised temperature, acidic pH, and longer exposure time, while on the contrary, reducing the water activity of a food product (e.g. through drying or concentrating) has an antagonistic effect. All microorganisms do not have the same sensitivity to CO₂ and the operating conditions and set of hurdles needed to inactivate different microbes, moulds, yeasts and spores will vary, some organisms being much more resistant to CO₂ than others (Haas *et al.*, 1989), as is described here.

In addition to its potential as a hurdle for the preservation of milk and dairy foods, decades of research on the relationship between pressurized CO₂ and foods have uncovered several other interesting applications, exploiting different physicochemical properties of the gas. For example, the acceleration of the cheese-making process, the fractionation and purification of various milk and whey proteins, the extraction of specific fats and fatty acids, the synthesis of water-resistant edible packaging, and others, are briefly presented in this chapter.

8.2 Physicochemical Principles

Carbon dioxide, naturally present in the atmosphere, is a gas with many different interesting properties that render it useful for several types of food applications, such as foaming, acidifying, or sterilizing. CO₂ is not only inexpensive and readily available at high purity, but also safe to handle and to consume in small amounts, as it is typically present in most foods using the gas. Most of the CO₂ used during high-pressure processing is removed during the subsequent expansion to common environmental pressure, and CO₂ sourced from food fermentation does not contribute to the environmental greenhouse-gas problem, particularly if it is recycled (Brunner, 2005).

Above the critical temperature of 31°C and the critical pressure of 7.35 MPa (termed the ‘critical point’) (Butler, 1991), high-pressure carbon dioxide becomes ‘supercritical’, or sCO₂, a physical state where it possesses both the viscosity of a gas and the

density of a liquid, while diffusivity is about two orders of magnitude higher than in typical liquids (Brunner, 2005), which can facilitate its blending with various food substances and magnify some of its physicochemical properties. For example, sCO₂ has valuable solvent properties. Some of the solvation characteristics of sCO₂ applied to food ingredients are (Brunner, 2005):

- (i) sCO₂ dissolves nonpolar or slightly polar compounds;
- (ii) the solvent power for low molecular weight compounds is high, and decreases with increasing molecular weight;
- (iii) sCO₂ has high affinity with oxygenated organic compounds of medium molecular weight;
- (iv) free fatty acids and their glycerides exhibit low solubility;
- (v) pigments are even less soluble;
- (vi) liquid water is poorly soluble in sCO₂ (<0.5% w/w);
- (vii) proteins, polysaccharides, sugars and mineral salts are insoluble;
- (viii) higher pressures increase the solvent power of sCO₂ and enable the dissolution of less volatile compounds, or compounds with a higher molecular weight or higher polarity.

8.2.1 Solubility of CO₂ in Aqueous Solutions

In turn, CO₂ is quite soluble in water and aqueous solutions, and even more soluble in nonpolar materials such as lipids (Hotchkiss and Loss, 2006). The amount of CO₂ dissolved into a liquid is termed the CO₂ concentration, [CO₂], typically expressed in ppm, g/kg or g/g. The maximum possible CO₂ concentration, the saturation solubility, is obtained at the thermodynamic equilibrium and depends on several factors, such as the CO₂ pressure, the temperature and the composition of the solution. If CO₂ is added in excess of the saturation solubility value, CO₂ bubbles form that can be dispersed throughout the liquid with mixing (Brunner, 2005).

The voluntary addition of CO₂ into aqueous solutions is called ‘carbonation’, and is often aimed at lowering the pH of the liquid through the production of carbonic acid, bicarbonates and hydronium ions, according to the following chain reactions, for which their equilibriums in water at 25°C are also shown (Garcia-Gonzalez *et al.*, 2007):

- (a) CO_{2(g)} ↔ CO_{2(aq)}, [CO₂]_{aq} = H × P_{CO₂} with H = 3.3 × 10⁻² mol/(l.atm)
- (b) CO_{2(aq)} + H₂O ↔ H₂CO₃, [H₂CO₃]/[CO₂]_{aq} = 1.7 × 10⁻³ mol/l
- (c) H₂CO₃ ↔ HCO₃⁻ + H⁺, [H⁺][HCO₃⁻]/[H₂CO₃] = 2.5 × 10⁻⁴ mol/l
- (d) HCO₃⁻ ↔ CO₃²⁻ + H⁺, [H⁺][CO₃²⁻]/[HCO₃⁻] = 5.61 × 10⁻¹¹ mol/l

Most of the CO₂ dissolved in water remains in the solvated form of CO₂, CO_{2(aq)}. A small portion of CO_{2(aq)} reacts with water to form carbonic acid, H₂CO₃, then a portion of H₂CO₃ dissociates into H⁺ and HCO₃⁻, which can further dissociate to CO₃²⁻ and H⁺ (Hotchkiss and Loss, 2006). The equilibrium constants of all the reactions depend on the pressure and the temperature, P and T. The last two steps (c and d) are pH dependent. Water saturated with CO₂ at atmospheric pressure and room temperature has a pH of approximately four. This equilibrium shifts when P or T changes: the saturation solubility of CO₂ increases with higher CO₂ pressure and lower temperature, which generally lowers the pH of the carbonated solution. Pressure also

positively controls the rate of dissolution of CO₂ in the solution and, above the critical point, higher temperatures decrease the density of sCO₂ and reduce its solvent properties (Brunner, 2005).

8.2.2 Solubility of CO₂ in Milk

Fresh raw milk naturally contains approximately 5.5 milli-moles (mM) of CO₂ immediately after milking (Lee, 1996). During refrigerated transport to commercial milk plants, the CO₂ dissolved in raw milk equilibrates with the CO₂ in the atmosphere and its concentration drops to about 2 mM upon arrival at the plant (Noll and Supplee, 1941). The pH of raw milk is near 6.8. Pasteurization treatments and other processes applied to the milk, including high temperatures, low pressures or aeration, cause the vaporization of 60–70% of the CO₂ content from milk and bring [CO₂] to about 0.7 mM in pasteurized milk (Moore *et al.*, 1961; Smith, 1964).

Pre- or post-pasteurization, the pH and CO₂ content of fluid milk can easily be manipulated with the addition of CO₂ at various temperatures and pressures, to incorporate CO₂ in a range of concentrations up to the saturation solubility at the current T and P. For example, at pH 6.3–6.5, approximately 88% of the CO₂ in milk exists as CO_{2(aq)}, 2% as carbonic acid, and the remaining 10% as bicarbonates (Daniels *et al.*, 1985). Different studies have shown that injecting 33.6 mM of CO₂ to raw milk at 15°C lowers the pH from 6.8 to approximately 6.1 (Martin *et al.*, 2003), 35 mM CO₂ added to milk at 4°C lowers pH from 6.7 to 5.9 (Loss and Hotchkiss, 2002), or 1000 ppm CO₂ added at 38°C lowers pH from 6.61 to 6.15 (Ma *et al.*, 2001), for example.

The solubility of CO₂ in milk and dairy products tends to decrease at higher temperature but a product's viscosity may reverse this trend by affecting the diffusivity of CO₂ in the product: for example, CO₂ is more soluble in warm, liquid milk fat than in cold, solidified milk fat such as butter (Ma and Barbano, 2003). In general, P has a greater influence on the solubility of CO₂ in milk, and its resulting pH, than T. At moderate temperatures (T = 25–50°C) the equilibrium solubility of CO₂ in milk is similar to that of water and increases approximately proportionally to P. At 25°C, the solubility of CO₂ in milk is about 10% lower than in water, probably due to steric and hydrostatic hindrances from the casein micelles. At 25°C, casein proteins are stable in milk saturated with CO₂ up to P = 6.9 MPa or more, and the pH decreases linearly with P. At 38°C, the casein begins denaturing when P reaches 2.8 MPa or higher, and the precipitated casein acts as a pH buffer and slows down the rate of pH decrease as a function of P. Between 38 and 50°C and for P = 2.8–6.9 MPa, the solubility of CO₂ in milk is quasi identical to that in water (Tomasula and Boswell, 1999; Tomasula *et al.*, 1999). The solubility of CO₂ in whey solutions is also proportionate to P. The pH of saturated whey protein solutions decreases logarithmically with P but increases with protein concentration due to the strong buffering properties of whey proteins; on the other hand, small variations of T have little influence on pH and the saturation solubility of CO₂ (Yver *et al.*, 2011; Bonnaillie and Tomasula, 2012b).

The freezing point of milk decreases slightly when CO₂ is dissolved, proportionally to the CO₂ concentration. The freezing point and pH changes caused by moderate CO₂ concentrations are reversible upon removal of the dissolved CO₂ (Ma *et al.*, 2001), while the injection of larger CO₂ amounts at higher temperatures and pressures

may cause the irreversible precipitation of the caseins (Tomasula *et al.*, 1999) or of the whey proteins (Bonnaillie and Tomasula, 2012b) from milk or whey.

8.3 Microbiological Action of High-Pressure and Supercritical CO₂

The acidification and solvent properties of CO₂ confer it antibacterial properties, which are enhanced as the amount of CO₂ present in an aqueous medium increases, for example when the solubility increases with lower temperature or with higher CO₂ pressure (Enfors and Molin, 1981). Both the acidification and solvent effects of CO₂ become maximized in the supercritical state; when supercritical, the liquid-like density enhances the solvating power of sCO₂ compared to the gaseous state, and the gas-like mass transport properties facilitate its diffusion compared to the liquid state. These properties, combined with its very low surface tension (Garcia-Gonzalez *et al.*, 2007), enable sCO₂ to penetrate various microporous materials, including bacterial cells, more effectively than either gaseous or liquid CO₂, to extract vital intracellular components and disrupt the cells' biological systems (Tomasula, 2003; Gunes *et al.*, 2005).

Several studies have indicated that the acidifying and pressure-dependent solvating effects of CO₂ seem to work in synergy, and that pH-lowering of a medium alone with another acid, or pressurization alone with air or nitrogen, are not nearly as effective at inhibiting bacterial growth as pressurized CO₂. Indeed, while nitrogen or air pressurized to up to 13.7 MPa at temperatures between 20 and 42°C, for varied lengths of time, showed extremely little to no inactivation effect on different bacteria, CO₂ caused a 1 to 9 log (which is total) deactivation in the same conditions, depending on the types of bacteria treated (Fraser, 1951; Haas *et al.*, 1989; Wei *et al.*, 1991; Lin *et al.*, 1992; Nakamura *et al.*, 1994; Enomoto *et al.*, 1997; Debs-Louka *et al.*, 1999). On another hand, comparing CO₂ with N₂O, a gas possessing many of the critical, steric, polar and solvent properties of CO₂ but no acidifying properties, a much greater inactivation of *E. coli* and *S. cerevisiae* was shown with CO₂ than with N₂O in the exact same conditions (Fraser, 1951; Enomoto *et al.*, 1997), owing to CO₂'s pH-lowering properties. At the same time, CO₂ possesses a greater inhibitory effect on microorganisms than many other acids, such as hydrochloric and phosphoric acid (Haas *et al.*, 1989; Wei *et al.*, 1991): when CO₂ lowers the pH of a medium, it increases the outer permeability of bacterial cells similarly to other acids, but this in turn facilitates the penetration of CO₂ into the microbial cells and activates its solvent effect inside the cells (Lin *et al.*, 1994). The synergistic acidifying and solvating effects of CO₂ likely explain why CO₂ penetrates cells much faster than other nonacidifying gases (Garcia-Gonzalez *et al.*, 2007).

8.3.1 Mechanism of Action of CO₂

Carbon dioxide can affect microorganisms in two different ways, depending on the temperature and pressure employed: (i) at low pressure and low temperature, as is used in modified atmosphere packaging (MAP), CO₂ displaces oxygen and inhibits the growth and multiplication of common aerobic pathogens, and also lowers the pH of the

medium surrounding the pathogens, imitating their own output and further inhibiting their growth; (ii) at high pressures and low-to-moderate temperature, CO₂ initiates deleterious activities inside the cells that injure or kill, and potentially totally inactivate the microorganisms, enabling the sterilization of a product to prevent long-term spoilage (Hagemeyer and Hotchkiss, 2011).

The mechanism of microbiological inactivation of high-pressure CO₂ is currently believed to comprise seven steps (Spilimbergo and Bertucco, 2003; Damar and Balaban, 2006; Garcia-Gonzalez *et al.*, 2007, 2009):

1. The solubilization of pressurized CO₂ in the liquid around the microbial cells decreases the liquid's pH, that is, the extracellular pH, pH_{ex}.
2. Owing to a high theoretical lipophilic affinity (Spilimbergo *et al.*, 2002), aqueous CO₂ diffuses into the plasma membrane of microbial cells and accumulates within the phospholipids in the inner layer (Garcia-Gonzalez *et al.*, 2007). This CO₂ accumulation causes a loss of order between the tightly-packed lipid chains, which increases the fluidity of the cell membrane and its permeability to CO₂ (Jones and Greenfield, 1982). In addition, HCO₃⁻ ions can further alter the membrane's permeability by modifying the charges on the phospholipid head groups and proteins located all over the surface (Garcia-Gonzalez *et al.*, 2007).
3. The increased membrane permeability enables aqueous CO₂ to penetrate into the cytoplasmic interior of microbial cells, where it is converted to carbonic acid and triggers a rapid drop in intracellular pH, pH_{in}, when HCO₃⁻ and H⁺ are formed. The microbial cells try to counter pH variations by expelling the excess protons (H⁺) from the cytoplasm against the prevailing pH gradient (pH_{in}–pH_{ex}) and the electrochemical (membrane potential) gradient, using a membrane-bound H⁺-ATPase (Hutkins and Nannen, 1993). But, when excessive CO₂ enters the cytoplasm, the cells are unable to expel all the resulting protons and pH_{in} begins to decrease (Spilimbergo and Mantoan, 2005). On the contrary, non-acidic gases such as N₂O induce membrane permeabilization but do not subsequently lower the intracellular pH (Giulitti *et al.*, 2011).
4. The lowering of the internal pH may cause the inhibition or inactivation of key enzymes essential for metabolic and regulating processes through possible conformational changes, as enzymes activity declines sharply away from their optimum pH (Hutkins and Nannen, 1993).
5. The permeated molecular CO₂ and HCO₃⁻ generated can directly disrupt the cell's metabolic reactions, by affecting anion-sensitive sites on key enzymes, particularly decarboxylating enzymes (Gill and Tan, 1979), and by displacing the equilibriums and inhibiting or stimulating the carboxylation and decarboxylation metabolic reactions, which synthesize particular amino acids and nucleic acids (Jones and Greenfield, 1982). An excessive stimulation of metabolic pathways can lead to deleterious net energy expenditure and loss of ATP (Dixon and Kell, 1989; Hong and Pyun, 2001).
6. The CO₃²⁻ ions created can disorder the intracellular electrolyte balance by precipitating with Ca²⁺-binding proteins as well as intracellular electrolytes such as Ca²⁺ and Mg²⁺, which are regulators of a large number of cell activities and aid in maintaining the osmotic relationships between cells and their surrounding media (Garcia-Gonzalez *et al.*, 2007).
7. Finally, high-pressure CO₂ is a powerful solvent and CO_{2(aq)} may solvate hydrophobic intracellular components such as phospholipids. Upon sudden pressure release, the solvated compounds are extracted from the cells at the same time as CO₂ (Lin *et al.*, 1992). Repeated pressurization cycles can increase the

extraction process and, thereby, cell inactivation. A fast depressurization may also cause some deformation or damage to the cells' membrane, but not enough to leak cytoplasm into the solution (Garcia-Gonzalez *et al.*, 2007).

Steps 3 to 6 are the most lethal and probably act in synergy to inactivate and kill bacterial cells (Garcia-Gonzalez *et al.*, 2007).

8.3.2 Influence of Processing Parameters: T, P, Agitation and Time

In general, increasing either the pressure, rate of agitation or exposure time employed during CO₂ processing of food products enhances the resulting microbial deactivation. Agitation increases the contact between both gaseous and aqueous CO₂ and the microorganisms, as well as the rate of decomposition of CO₂ into carbonic acid and the consequent pH reduction. Without agitation, only the microbial cells on the surface of the food will be in immediate contact with CO₂, the rest depending on the slow diffusion of CO₂ through the media.

When the CO₂ pressure is increased, shorter exposure times are needed to inactivate the same number of microbial cells. Supercritical CO₂ is also more effective than subcritical CO₂ at penetrating cells and effecting microbial inactivation owing to its enhanced solubility, surface tension and mass-transport properties (Lin *et al.*, 1992; Werner and Hotchkiss, 2006). Fast depressurization (flash decompression) may help to enhance cell death through the rupture of some cell walls during the rapid release of the applied pressure. The intensive localized cooling caused by the Joule–Thomson effect during CO₂ expansion may also play some role in cell lysis; however, the physiological mechanisms (steps 1 to 7 above) predominate over mechanical cell rupture (Garcia-Gonzalez *et al.*, 2007).

The processing temperature (T) possesses an optimal operating range to maximize microbial deactivation: higher T can facilitate the cell penetration by increasing both the CO₂ diffusivity and the fluidity of the cell membrane (Hong and Pyun, 1999), thus stimulating step 2. However, excessive T can reduce the solubility of CO₂ and diminish its solvent and acid properties, and can also deteriorate the quality of the food treated (Garcia-Gonzalez *et al.*, 2007). Temperatures between 20 and 45°C have successfully been used for the CO₂ treatment of water-based media under moderate pressure and exposure time (Table 8.1). In the treatment of milk and dairy products, temperatures well below 45°C must be used to prevent protein precipitation, melting and so on. At these low temperatures, the considerably lower microbial inactivation power of CO₂ can be compensated with much longer exposure times and/or much higher pressures in order to enact total bacterial inactivation (Table 8.2).

Because the specific survival curves of different microorganisms are not log-linear, inactivation with CO₂ also is not a log-linear function of time (Garcia-Gonzalez *et al.*, 2009), and the susceptibility of particular bacteria to CO₂ treatment will depend on time as well as on the pressure and temperature histories.

8.3.3 Inactivation of Different Microorganisms with CO₂

The main pathogenic microorganisms types include Gram-positive (G+) and Gram-negative (G-) vegetative bacteria, yeasts, fungi, and bacterial and fungal spores. G+ bacteria possess a peptidoglycan outer membrane, while G- bacteria

have a lipopolysaccharide/protein outer membrane in addition to a peptidoglycan inner membrane. Because of their extra membrane and thicker cell wall, it is often assumed that G- bacteria are less susceptible to CO₂ treatment than G+; although this often seems to be the case, the body of research on this topic is conflicting (Garcia-Gonzalez *et al.*, 2009). For example, CO₂ treatment at 10.5 MPa and 35°C for 20 minutes is effective at deactivating a variety of G+ and G- vegetative bacteria, with degrees of inactivation ranging from 1.9 to 6.4 log reductions. Among the tested vegetative cells, *A. acidoterrestris* and *E. faecalis*, both G+, were the most resistant to CO₂ inactivation, with less than 0.3 log reductions, probably due to their acidophilic behaviour and tolerance to low pH (Garcia-Gonzalez *et al.*, 2009).

Vegetative bacteria include psychrotrophs that are capable of growth at temperatures at or less than 7°C and are responsible for spoiling refrigerated foods. Freezing temperatures halt the growth of psychrotrophs and they are mostly killed by traditional HTST. Bacteria that can survive pasteurization are called thermophilic bacteria; thermophilic psychrotrophs are less common and are bacteria that survive pasteurization and can also grow at refrigeration temperatures, such as spore-forming *Bacillus*. They can spoil pasteurized foods even without post-pasteurization contamination.

Yeasts and spores are less sensitive to high pressure CO₂ than most vegetative bacteria. After CO₂ treatment at 10.5 MPa and 35°C for 20 minutes, Garcia-Gonzalez *et al.* (2009) saw log reductions smaller than two for different types of yeasts. At moderate temperature (20–45°C), bacterial and fungal spores are very resistant to CO₂ treatment and the viable spore counts is only reduced by 1–2 log with CO₂ pressures up to 30 MPa (Table 8.1) (Damar and Balaban, 2006; Garcia-Gonzalez *et al.*, 2007, 2009). Treatments combining one or more of the following with supercritical CO₂ application may help inactivate spores successfully: higher temperature, longer contacting time, pressure cycling, lower pH, pulsed electric fields and H₂O₂ (Spilimbergo *et al.*, 2002; Garcia-Gonzalez *et al.*, 2007). For example, mixing CO₂ microbubbles in the media through a microfilter maximizes CO₂ concentration and can improve contact with the microorganisms as well as further lower the pH (Garcia-Gonzalez *et al.*, 2007). Combination treatments may then cause spores to germinate and become more sensitive to CO₂ deactivation. For example, the combination of heat treatment at 60–95°C and pressure cycling with sudden pressure releases is able to cause *Bacillus cereus* spores to germinate, after which they can be inactivated by supercritical CO₂ (Dillow *et al.*, 1999; Spilimbergo *et al.*, 2002). sCO₂ treatment at 20 MPa for four hours at 60°C (a combination of high P, high T and a long exposure time) was shown to inactivate *B. cereus* completely (Dillow *et al.*, 1999).

Depending on the microorganism, CO₂ can also inflict nonlethal injury, permitting the cells to recover later and cause food poisoning or spoilage. In one instance, injured cells of *S. aureus* started to recover after two hours of incubation in the recovery medium, whereas *E. coli* cells did not recover after 30 hours of incubation (Sirisee *et al.*, 1998; Kobayashi, 2007).

Table 8.1 presents the available literature data for a wide variety of vegetative bacteria, yeasts, fungi and spores grown in diverse water-based media, broths or synthetic media, and treated with CO₂ at different pressures (with or without cycling), temperatures and exposure times. The starting cell concentration before application of CO₂ was generally between 10⁷ and 10⁸ colony forming units (CFU)/ml for vegetative bacteria and 10⁶ CFU/ml for yeasts (Garcia-Gonzalez *et al.*, 2009), and the resulting degree of inactivation, DI, is the log-reduction of the number of microorganisms before and after CO₂ processing: $DI = -\log_{10}(N/N_0)$, where N₀ and N are the microorganism counts before and after processing.

Table 8.1 Inactivation of microorganisms in various media with pressurized CO₂ as a function of pressure, temperature, time and number of cycles. Data gathered by Garcia-Gonzalez *et al.* (Garcia-Gonzalez *et al.*, 2007, 2009), plus other references; all references are listed herein

Microorganism name	Type	Media	P _{CO₂} (MPa)	T (°C)	Time (min)	Cycles	Log reduction* = total	Ref.
<i>Aeromonas hydrophila</i>	G-	BHI broth, pH 6.5	10.5	35	20		5.4	^a
<i>Alicyclobacillus acidoterrestris</i>	G+	BHI broth, pH 6.5	10.5	35	20		0.1	^a
	spore	BHI broth, pH 6.5	10.5	35	20		0	^a
<i>Aspergillus niger</i> spores	Fungi	BHI broth, pH 6.5	10.5	35	20		0.1	^a
<i>Bacillus cereus</i>	G+	BHI broth, pH 6.5	10.5	35	20		2.7	^a
	spore	BHI broth, pH 6.5	10.5	35	20		1.2	^a
	spore	Growth medium	20.5	60	120	6	5	^c
	spore	Growth medium	20.5	60	240	6	8*	^c
<i>Bacillus subtilis</i>	G+	PS	7.4	38	2.5		7*	^o
	G+	Phosphate buffer	7.4	40	2.5		7.6	^p
<i>Brochothrix thermosphacta</i>	G+	BHI broth, pH 6.5	10.5	35	20		4.5	^a
	G+	BHI broth, pH 6.5	6	45	30		6*	^u
	G+	PS	6	45	5		6*	^u
<i>Candida lambica</i>	Yeast	BHI broth, pH 6.5	10.5	35	20		2.1	^a
<i>Enterococcus faecalis</i>	G+	BHI broth, pH 6.5	10.5	35	20		0.2	^a
	G+	Hydrophilic paper	5	RT	200		1	^f
	G+	Hydrophilic paper	5	RT	420		2	^f
	G+	PS	6	45	15		8*	^t
<i>Escherichia coli</i>	G-	Dry (6% water)	5	RT	300		0.1	^f
	G-	Dry (2 - 10% water)	20	35	120		1.3	^l
	G-	Synthetic medium	3.5	37.5	3		1.6	^e
	G-	Water	20	34	10		2.5	^q

(continued overleaf)

Table 8.1 (continued)

Microorganism name	Type	Media	P _{CO2} (MPa)	T (°C)	Time (min)	Cycles	Log reduction ^a = total	Ref.
	G-	Phosphate buffer	31	35	40		3.5	r
	G-	PS or distilled water	4	20	120		3.9	l
	G-	PS or distilled water	4	35	120		4	l
	G-	Hydrophilic paper	5	RT	200		4	f
	G-	BHI broth, pH 6.5	10.5	35	20		4.2	a
	G-	PS or distilled water	10	35	120		4.2	l
	G-	PS or distilled water	20	20	120		4.4	l
	G-	PS or distilled water	10	20	120		4.5	l
	G-	PS or distilled water	20	35	120		5.1*	l
	G-	Hydrophilic paper	5	RT	420		6	f
	G-	Nutrient broth	6.2	?	120		6.3*	d
	G-	Phosphate buffer	31	42.5	10		7	r
	G-	Nutrient broth	10	30	50		7.5*	w
	G-	Growth medium	20.5	34	30	3	8*	c
	G-	Growth medium	11	38	45		8.6*	c
	G-	Growth medium	20.5	42	20		9*	c
<i>Lactobacillus brevis</i>	G+	PS	5	35	15		2	m
	G+	PS	7	25	15		2	m
	G+	PS	25	35	15		6*	m
<i>Lactobacillus plantarum</i>	G+	Phosphate buffer	6.9	30	120		7.3	k
	G+	Distilled water	6.9	30	120		7.9	k
	G+	Acetate Buffer, pH 4.5	6.9	30	60		8.7*	k
<i>Lactobacillus sakei subsp. carnosum</i>	G+	BHI broth, pH 6.5	10.5	35	20		4	a
<i>Legionella dunnii</i>	G-	Growth medium	20.5	40	90	6	4	c
<i>Listeria innocua</i>	G+	Growth medium	20.5	34	36	3	3	c

<i>Listeria monocytogenes</i>	G+	Growth medium	20.5	34	36	6	9*	^c
	G+	BHI broth, pH 6.5	10.5	35	20		4.5	^a
	G+	PS	6	45	60		7*	^s
	G+	Distilled water	6.2	35	120		8.9*	^g
	G+	Distilled water	13.7	35	120		9*	^g
	G+	Growth medium	6.9	45	8		9.9*	^b
<i>Penicillium roqueforti</i> spores	Fungi	BHI broth, pH 6.5	10.5	35	20		1	^a
	G-	Growth medium	20.5	34	36	3	8*	^c
<i>Proteus vulgaris</i>	G-	Growth medium	20.5	34	36	3	6	^c
	G-	Growth medium	20.5	34	36		6	^c
	G-	PS	7.4	38	2.5		7*	^o
<i>Pseudomonas fluorescens</i>	G-	BHI broth, pH 9	10.5	35	5		2	^a
	G-	BHI broth, pH 8	10.5	35	5		3	^a
	G-	BHI broth, pH 5 to 7	10.5	35	5		3.5	^a
	G-	BHI broth, pH 6.5	10.5	35	20		4	^a
	G-	BHI broth, pH 4.5	10.5	35	5		4	^a
	G-	BHI broth, pH 4	10.5	35	5		7.5*	^a
<i>Saccharomyces cerevisiae</i>	Yeast	Dry (2-10% water)	20	35	120		0.3	^l
	Yeast	Dry (6% water)	5	RT	300		0.6	^f
	Yeast	PS or distilled water	4	20	120		0.1	^l
	Yeast	PS or distilled water	4	35	120		0.1	^l
	Yeast	PS or distilled water	10	20	120		0.3	^l
	Yeast	PS or distilled water	20	20	120		0.9	^l
	Yeast	BHI broth, pH 6.5	10.5	35	20		1	^a
	Yeast	Hydrophilic paper	5	RT	200		2	^f
	Yeast	PS	7	25	15		2.5	^m

(continued overleaf)

Table 8.1 (continued)

Microorganism name	Type	Media	P _{CO2} (MPa)	T (°C)	Time (min)	Cycles	Log reduction ^a = total	Ref.	
Yeast	Yeast	Hydrophilic paper	5	RT	420		3	f	
	Yeast	PS	5	35	15		3	m	
	Yeast	PS or distilled water	10	35	120		3.9	l	
	Yeast	Growth medium	6.9	25	45		4	h	
	Yeast	Growth medium	13.8	25	35		4	h	
	Yeast	PS	25	35	15		5	m	
	Yeast	Phosphate buffer	7.4	40	10		5.8*	p	
	Yeast	PS or distilled water	20	35	120		6.3*	l	
	Yeast	Distilled water	4	40	240		6.8	j	
	Yeast	Growth medium	6.9	35	15		7*	h	
	Yeast	Growth medium	20.7	25	60		7*	h	
	Yeast	Growth medium	13.8	35	10		7*	h	
	Yeast	Distilled water	4	40	180		8*	i	
	<i>Salmonella typhimurium</i>	G-	BHI broth, pH 6.5	10.5	35	20		3	a
	<i>Salmonella salford</i>	G-	Growth medium	20.5	34	36	3	3	c
G-		Growth medium	20.5	34	36	6	3	c	
G+		Dry (2-10% water)	20	35	120		1.4	l	
<i>Staphylococcus aureus</i>	G+	BHI broth, pH 6.5	10.5	35	20		3	a	
	G+	Growth medium	20.5	34	36	3	3	c	
	G+	Water	20	34	10		3.5	q	
	G+	PS or distilled water	20	35	120		4.8*	l	
	G+	Growth medium	40	37	60	4	4.8	y	
	G+	Growth medium	10	45	60		5.7	y	
	G+	Growth medium	10	55	60		6.0	y	
	G+	Phosphate buffer (=pH 7)	31	42.5	10		6.4	r	
	G+	Phosphate buffer	31	35	30		7	r	
	G+	Growth medium	20.5	34	36	6	7*	c	

<i>Staphylococcus saprophyticus</i>	G+	Growth medium, pH 9	5.5	22	120	0.7	^d
	G+	Growth medium, pH 7.4	5.5	22	120	2.4	^d
	G+	Growth medium, pH 5	5.5	22	120	3.9	^d
<i>Yersinia enterocolitica</i>	G-	BHI broth, pH 6.5	10.5	35	20	3.8	^a
	G-	PS	6	45	12	5.5	^v
<i>Zygosaccharomyces bailii</i>	Yeast	BHI broth, pH 6.5	10.5	35	20	0.4	^a

BHI = brain heart infusion broth (Oxoid, Basingstoke, England). PS = physiological saline. ^a = (Garcia-Gonzalez *et al.*, 2009); ^b = (Lin *et al.*, 1994); ^c = (Dillow *et al.*, 1999); ^d = (Haas *et al.*, 1989); ^e = (Fraser, 1951); ^f = (Debs-Louka *et al.*, 1999); ^g = (Wei *et al.*, 1991); ^h = (Lin *et al.*, 1992); ⁱ = (Nakamura *et al.*, 1994); ^j = (Enomoto *et al.*, 1997); ^k = (Hong and Pyun, 1999); ^l = (Kamihira *et al.*, 1987); ^m = (Ishikawa *et al.*, 1995); ⁿ = (Werner and Hotchkiss, 2006); ^o = (Spilimbergo *et al.*, 2002); ^p = (Spilimbergo *et al.*, 2003b); ^q = (Spilimbergo *et al.*, 2003a); ^r = (Sirisee *et al.*, 1998); ^s = (Erkmen, 2000a); ^t = (Erkmen, 2000b); ^u = (Erkmen, 2000c); ^v = (Erkmen, 2001a); ^w = (Erkmen, 2001b); ^x = (Erkmen, 1997); ^y = (Huang *et al.*, 2009).

Table 8.2 Inactivation of microorganisms with pressurized CO₂ in inoculated pasteurized or raw milk and various food ingredients

Microorganism name	Type	Medium	P _{CO₂} (MPa)	T (°C)	Time (min)	[CO ₂] (w/w) pH	Log reduction* * = total	Ref.
<i>Brochothrix thermosphacta</i>	G+	PS	6	45	5	No mixing	6*	u
		Whole milk Skimmed milk	6	45	150	No mixing	0.4 1.9	u u
<i>Enterococcus faecalis</i>	G+	PS	6	45	15	No mixing	8*	t
		Whole milk Skimmed milk	6	45	1440	No mixing	5.8* 5.8*	t t
<i>Escherichia coli</i>	G-	Nutrient broth	10	30	50	No mixing	7.5*	w
		Whole milk	10	30	360	No mixing	1.2	w
		Skimmed milk	10	30	360	No mixing	2.2	w
<i>Listeria monocytogenes</i>	G+	PS	6	45	60	No mixing	7*	s
		Growth medium	6.9	45	8		9.9*	b
		Whole Milk	6.9	45	60		1	b
		Reduced-fat milk	6.9	45	60		5.9	b
		Lactose-reduced skimmed milk	6.9	45	60		6.2	b
		Skimmed milk Whole milk	6 6	45 45	960 1440	No mixing	6.5* 6.9*	s s
<i>Pseudomonas fluorescens</i>	G-	BHI broth, pH 6.5	10.5	35	20		4	a

	+ 1–30% starch	10.5	35	20	4, no effect of starch	^a
	+ 0.5–23% NaCl	10.5	35	5	2–3 at 0.5%; 4–5 at 2–8%; 7 at 16%, 7.5* at 23%	^a
	+ 0.5% Tween 80 + 1–30% sunflower oil	10.5	35	20	6 at 0%; 5 at 1%; 4 at 10%; 3 at 30%.	^a
	+ 10% egg yolk	10.5	35	20	5	^a
	+ 0.01–0.05% sucrose stearate emulsifier	10.5	35	20	5–5.8	^a
	+ 5–30% gelatin	10.5	35	20	3 at 5%; 2 at 10–15%; 0.5 at 30%	^a
	+ 3–33% glycerol	10.5	35	20	No change up to 20%. 2.6 at 33%.	^a
<i>Pseudomonas fluorescens</i>	+ 7–52% sucrose	10.5	35	20	No change up to 26%. 1.5 at 52%.	^a
	+ 1% whey proteins	10.5	35	20	3.8	^a
	+ 10% whey proteins	10.5	35	20	3	^a
	Skimmed milk	10.3	30	10	6.6%	ⁿ

(continued overleaf)

Table 8.2 (continued)

Microorganism name	Type	Medium	P _{CO₂} (MPa)	T (°C)	Time (min)	[CO ₂] (w/w) pH	Log reduction ^a = total	Ref.
		Skimmed milk	20.7	30	10	13.2%	2.9	n
		Skimmed milk	20.7	35	10	6.6%	3.5	n
		Skimmed milk	10.3	35	10	13.2%	3.7	n
		Skimmed milk	13.8	35	10	13.2%	4.2	n
		Skimmed milk	20.7	35	10	13.2%	5	n
		Whole milk	bubbled	50	35	0.066%, pH 6.25	3.5	z
		Whole milk	bubbled	50	35	0.092%, pH 6.13	4	z
		Whole milk	bubbled	50	20	0.158%, pH 6.04	7*	z
<i>Staphylococcus aureus</i>	G+	BHI broth, pH 6.5	10.5	35	20		3	a
		+ 23% NaCl, pH 6.5	10.5	35	20		4	a
		+ 52% sucrose, pH 6.5	10.5	35	20		0.2	a
		+ 33% glycerol, pH 6.5	10.5	35	20		1.2	a
		Whole milk	6	25	120	No mixing	0.2	x
		Whole milk	7	25	120	No mixing	1.1	x
		Whole milk	8	25	120	No mixing	2.2	x
		Whole milk	9	25	120	No mixing	4.2	x
		Whole milk	10	25	120	No mixing	5.1	x
		Whole milk	12	25	180	No mixing	5.8	x
		Whole milk	14.6	25	300	No mixing	5.8*	x
		Skimmed milk	6	25	120	No mixing	0.4	x
		Skimmed milk	7	25	120	No mixing	1.7	x
		Skimmed milk	8	25	120	No mixing	2.9	x
<i>S. aureus</i> (continued)	G+	Skimmed milk	9	25	60	No mixing	4.2	x

RAW MILK (fresh or aged)	mix	Whole milk	6	45	150	No mixing	0.7	<i>u</i>
Native aerobic flora		Skimmed milk	6	45	120	No mixing	2.7	<i>u</i>
		Skimmed milk	6	45	360	No mixing	2.9	<i>s</i>
		Skimmed milk	6	45	360	No mixing	2.9*	<i>v</i>
		Skimmed milk	10.3	30	10	6.6%	1.2	<i>n</i>
		Skimmed milk	10.3	35	10	6.6%	3.1	<i>n</i>
		Skimmed milk	13.8	35	10	6.6%	3.5	<i>n</i>
		Skimmed milk	20.7	30	10	6.6%	3.6	<i>n</i>
		Skimmed milk	20.7	30	10	13.2%	3.9	<i>n</i>
		Skimmed milk	10.3	35	10	13.2%	3.8	<i>n</i>
		Skimmed milk	13.8	35	10	13.2%	4.7	<i>n</i>
		Skimmed milk	17.2	35	10	13.2%	5.2	<i>n</i>
		Skimmed milk	20.7	35	10	13.2%	5.4	<i>n</i>
		Skimmed milk	48.3	40	10	13.2%	4.5	<i>n</i>
		Skimmed milk	48.3	40	10	0.3%	2.6	<i>n</i>
		Skimmed milk	48.3	40	10	0	2.5	<i>n</i>
		Whole milk	6	45	960	No mixing	4.6	<i>s</i>
		Whole milk	6	45	960	No mixing	4.9*	<i>v</i>
		Whole milk	6	45	1440	No mixing	5.8*	<i>t</i>
		Skimmed milk	6	45	960	No mixing	5.8*	<i>t</i>
		Whole milk	9	25	60	No mixing	3.0	<i>x</i>
		Skimmed milk	9	25	60	No mixing	3.1	<i>x</i>
		Whole milk	9	25	120	No mixing	4.1	<i>x</i>

(continued overleaf)

Table 8.2 (continued)

Microorganism name	Type	Medium	P _{CO₂} (MPa)	T (°C)	Time (min)	[CO ₂] (w/w) pH	Log reduction *= _{total}	Ref.
		Skimmed milk	9	25	120	No mixing	*	x
		Whole milk	10	25	120	No mixing	5.8	x
		Whole milk	12	25	180	No mixing	6.2	x
		Skimmed milk	15	35–38	15	30–33%	N/A. Shelf life >35 days	y
		Whole milk	25	50	70	No mixing	5.0	aa
Native yeasts and moulds		Raw whole milk	25	40	70	No mixing	3.2*	aa
Native Coliform Bacteria		Raw whole milk	25	20	70	No mixing	2.2*	aa

* = total inactivation; PS = physiological saline; No mixing = test tubes containing 10-ml milk samples were placed under static pressurized CO₂.

^a = (Garcia-Gonzalez *et al.*, 2009);

^b = (Lin *et al.*, 1994);

^r = (Werner and Hotchkiss, 2006);

^s = (Erkmen, 2000a);

^t = (Erkmen, 2000b);

^u = (Erkmen, 2000c);

^v = (Erkmen, 2001a);

^w = (Erkmen, 2001b);

^x = (Erkmen, 1997);

^y = (Di Giacomo *et al.*, 2009);

^z = (Hotchkiss and Loss, 2006);

^{aa} = (Hongmei *et al.*, 2014).

8.3.4 Kinetics of Bacterial Inactivation with CO₂

The changes in microbial populations versus time during a sterilization process are most commonly described by the survivor curve equation, which is analogous to the first-order kinetic model for chemical reactions:

$$\text{Log } N(t)/N_0 = -t/D$$

where $N(t)$ and N_0 are the microbial concentrations at time t and time zero, respectively, and D is the decimal reduction time, that is, the time required to effect a 1 log reduction in the microbial population (Perrut, 2012). However, some inactivation rate curves can be more or less concave, or even biphasic (having two different slopes) depending on the microorganism, the process and the treatment conditions (Garcia-Gonzalez *et al.*, 2007). In those cases, alternative models have been developed to describe non-log-linear data. One model, proposed by Xiong *et al.* (1999), uses four biologically and physically sound kinetic parameters to integrate three different classical models into one. The general expression is able to fit the four most commonly observed survival profiles: log-linear curves, curves with a shoulder, curves with a tailing (i.e. biphasic curves) and sigmoidal curves (Xiong *et al.*, 1999; Parton *et al.*, 2007):

$$\text{Log } N(t)/N_0 = 0, \text{ for } t \leq t_{\text{lag}}$$

$$\text{Log } N(t)/N_0 = \log (f \exp[-k_1(t - t_{\text{lag}})] + (1 - f) \exp[-k_2(t - t_{\text{lag}})]), \text{ for } t \geq t_{\text{lag}}$$

where f is the fraction of the total microorganisms population, $N(t)$, that is more sensitive to CO₂ deactivation, and $(1 - f)$ the fraction that is more resistant to deactivation; k_1 and k_2 ($k_1 > k_2 \geq 0$) are the death rate constants of these two fractions; and t_{lag} is the lag-time length. When the CO₂ action is immediate, $t_{\text{lag}} = 0$. The four different kinetics parameters corresponding to the CO₂ treatment of a given microbial population suspended in a given food matrix should be obtained by fitting experimental data (Parton *et al.*, 2007). Even when only one cellular strain is present, the parameters k_2 and f are useful to account for the strong effects of the substrate (or food) on the extent of microbial inactivation by CO₂: different substrates can heavily affect the death rate constants and the lag time by changing the microbial population distribution, the CO₂ diffusivity, the pH and buffering properties and so on, which can obstruct deactivation of the pathogens. For example, apple juice hinders the inactivation of yeast by CO₂ (Parton *et al.*, 2007).

8.4 High-Pressure CO₂ Treatment of Milk and Dairy Foods

8.4.1 Microbial Flora of Raw and Pasteurized Milk

The microbiological deterioration of refrigerated raw and pasteurized milk, cottage cheese and similar products results in flavour, textural and visual spoilage (Hotchkiss *et al.*, 2006). Eighty-one different bacterial strains have been identified in refrigerated raw milk (Ternstrom *et al.*, 1993). The average total bacterial count of raw milk entering three different milk processing plants was measured as 4–4.8 log CFU/ml (12 000–66 000 CFU/ml) by Fromm and Boor (2004), which is well below the

regulatory limit of 5.5 log CFU/ml (300 000 CFU/ml) before pasteurization. After HTST pasteurization and depending on the milk processing plant, the total bacterial count of commercial fluid milk typically averages (Fromm and Boor, 2004):

- 1.5–3.5 log CFU/ml on day 1
- 2.3–3.5 log CFU/ml on day 7
- 2.5–6.5 log CFU/ml on day 14
- 3.0–7.2 log CFU/ml on day 17.

The microorganisms responsible for dairy spoilage include (Ternstrom *et al.*, 1993; Jay, 2000; Boor and Murphy, 2002; Chambers, 2002; Fromm and Boor 2004; Hotchkiss *et al.*, 2006; Martin *et al.*, 2012a):

- Both Gram-positive (G+) and Gram-negative (G-) psychrotrophic bacteria are found in raw milk when refrigerated. Gram-negative bacteria have been reported to include *Pseudomonas*, *Acinetobacter*, *Flavobacterium*, *Enterobacter*, *Klebsiella*, *Aerobacter*, *Escherichia*, *Serratia*, *Proteus*, *Aeromonas*, *Burkholderia*, *Stenotrophomonas* and *Alcaligenes* (Ternstrom *et al.*, 1993; Hotchkiss *et al.*, 2006; Munsch-Alatossava and Alatossava, 2006; Singh *et al.*, 2012). *Pseudomonas* species such as *P. fluorescens biovar I*, *P. fragi*, *P. lundensis* and *P. fluorescens biovar III* (Ternstrom *et al.*, 1993) represent more than 50% of the G- population in milk and are killed by conventional HTST pasteurization; however, post-pasteurization contamination of fluid milk with G- psychrotrophs is common due to imperfect sanitation procedures, particularly from filling machines (Murphy, 2009). These bacteria produce extracellular proteases and lipases, causing protein and lipid degradation that results in undesirable off-flavours, mostly of the 'fruity' kind (Hotchkiss *et al.*, 2006), which limits the refrigerated shelf life of HTST-pasteurized milk to 14–17 days (Barbano *et al.*, 2006). Gram-positive, nonsporulating bacteria isolated from raw milk include species of *Propionibacteria*, *Staphylococcus* and several lactic acid bacteria, such as *Streptococcus*, *Leuconostoc*, *Lactobacillus*, *Lactococcus* and *Enterococcus* species (Hantsis-Zacharov and Halpern, 2007; Singh *et al.*, 2012). Milk quality can be affected by these microorganisms by the secretion of proteases and lipases; and due to the production of organic acids (e.g. acetic acid, lactic acid) spoil foods by causing a drop in the pH and curdling (Jay, 2000). The numbers of G+ organisms required to cause milk spoilage are generally higher than for G- bacteria and the changes can be less noticeable (Hotchkiss *et al.*, 2006).
- The spore-forming, thermophilic psychrotrophs, G+ rods *Bacillus*, *Paenibacillus* and *Microbacterium* are the predominant spoilage organisms that survive fluid milk pasteurization in commercial dairy plants (Ranieri *et al.*, 2009; Ivy *et al.*, 2012). Approximately 25% of all shelf life problems in pasteurized, refrigerated milk are due to thermophilic psychrotrophs, and primarily *Bacillus polymyxa* and *Bacillus cereus* that grow fermentatively in milk (Ternstrom *et al.*, 1993; Boor and Murphy, 2002). After HTST pasteurization, first *Bacillus*, then *Paenibacillus* strains begin to multiply during refrigerated storage and, surprisingly, grow faster if the milk is pasteurized at 85°C rather than at 72°C (Ranieri *et al.*, 2009; Martin *et al.*, 2012b). They induce lipolysis and proteolysis that generate off-flavours: free fatty acid contents approximately double in 17 days, while casein slowly breaks down into peptides (Fromm and Boor, 2004).

- Spores from *Paenibacillus* and *Bacillus* are typically present in low numbers in raw milk but are heat resistant. HTST-pasteurized fluid milk that achieves a shelf life of 17 days with a total bacteria count <20 000 CFU/ml will generally spoil by 21–28 days because of the growth of spore-formers (Barbano and Boor, 2007; Martin *et al.*, 2012a).
- A large variety of fungal species is also found in raw milk, such as *Candida* yeasts and *Geotrichum*, *Aspergillus* or *Penicillium* moulds (Torkar and Vengušt, 2008; Lavoie *et al.*, 2012).

While bacterial plate counts in milk correlate mostly to equipment sanitation, a high somatic cell count (SCC) due to mastitis of the cows can also cause milk spoilage (Barbano *et al.*, 2006). Somatic cells cause the release of a variety of hydrolytic enzymes that break down casein and milk fat and alter milk composition. The primary proteolytic enzyme is heat-stable plasmin and the primary lipolysis enzyme is lipoprotein lipase. Proteolysis and lipolysis release free fatty acids and small bitter or astringent peptides that induce rancidity and bitterness, particularly after milk storage times over 14 days at 5°C (Ma *et al.*, 2003).

8.4.2 Food Composition Affects the Bactericidal Action of CO₂

Garcia-Gonzalez *et al.* (2009) tested the effects of different parameters and food components added to BHI broth (initial pH 6.5) on the efficacy of sCO₂ to inactivate *Pseudomonas fluorescens*, the main bacteria responsible for milk spoilage, treated at 10.5 MPa and 35°C for 20 minutes (Table 8.2) (Garcia-Gonzalez *et al.*, 2009):

- The addition of up to 30% **starch** did not affect the bactericidal power of sCO₂, even though CO₂ adsorbs onto polysaccharides (e.g. potato and corn starch). In the range 0–29.4 MPa, the rate of CO₂ absorption first increases linearly with pressure, reaches a maximum, and then drops sharply into a pressure-independent plateau (Hoshino *et al.*, 1993).
- The addition of 10% whey **proteins** reduces the kill efficacy of sCO₂ by 1 log, due to the buffering properties of whey proteins that hinder pH reduction.
- The presence of **fats** (up to 30% sunflower oil) solubilizes CO₂ into the organic phase and draws CO₂ from the aqueous phase, preventing pH reduction and contact with the microorganisms and greatly reducing the bactericidal efficacy. Fats may also change the structure of cell walls and membranes and hamper CO₂ penetration into the cells (Lin *et al.*, 1994).
- Similarly, a lower water content (or lower **water activity**) protects the cells from deactivation by sCO₂ (Garcia-Gonzalez *et al.*, 2007).
- Low **salt** (NaCl) concentrations (≥0.5%) reduce CO₂ efficacy, but very high concentrations (up to 23%) enhance the bacterial kill of *P. fluorescens* by several logs, up to total deactivation. However, the addition of salt had little effect on the more salt-tolerant *Staphylococcus aureus*.
- Different **emulsifiers** can improve the dissolution of CO₂ in the aqueous medium and increase the permeability of the cell membrane, improving CO₂ efficacy. For example, sucrose stearate (0.01–0.05%) increases inactivation of *P. fluorescens* by 1.8 log, while 10% egg yolk, containing lecithin, causes only 1 log improvement due

to the opposing effect of fat in the yolk. In another study, 0.01% sucrose monolaurate helped the deactivation of *Listeria monocytogenes* (Kim *et al.*, 2008).

- **Alcohol** (Glycerol) has no noticeable effect up to 20% but protects *P. Fluorescens* and *S. aureus* at high concentration (33%). It is assumed that glycerol easily crosses the cell membrane and provides equilibration and protection against osmotic pressure.
- Similarly to glycerol, **sugar** (sucrose) has no effect up to 26%, but protects *P. fluorescens* and *S. aureus* from CO₂ at higher content (52%).
- The **initial pH** of the medium affects the pH depression produced by CO₂ and, thereby, influences the kill efficacy, which is lower at higher pH and greater at lower pH. In addition, lower pH values may also increase the cell permeability to CO₂.
- **Viscosity** higher than about 2.2–4.3 cP (by addition of 5–30% gelatin) hinders both the mixing and diffusion of CO₂ throughout the medium and thus greatly decreases the killing efficacy of CO₂.

In view of this, a sCO₂ pasteurization process would commercially be most effective on food products possessing several of the following attributes: a low fat content; a high water activity; low-to-moderate sugar, alcohol and protein contents; a low pH; a low viscosity. Many types of beverages fit this description well. For some other food products, the incorporation of a lot of salt or a little emulsifier can considerably enhance the efficacy of the process.

While fluid milk does not have a low pH, its fat, protein and sugar contents, low viscosity and high water content make it a viable candidate for CO₂ pasteurization, and more particularly skimmed milk. The high-pressure CO₂ process may not, however, be as effective at killing microorganisms in thicker dairy products with high protein and sugar contents, such as yogurts, and/or high fat content, such as soft cheeses and creams; in some of these cases, carbonation with low-pressure CO₂ was found to be a good alternative to prevent bacterial growths after conventional pasteurization and to extend shelf life (Section 8.5). In dry milk products (protein powders, lactose powders, nonfat dry milk, dry cheeses etc.), the antimicrobial power of CO₂ is the weakest because CO₂ needs water to dissolve, lower the pH and penetrate the cells. Dried cell walls are also shrunken, less porous and less flexible, and difficult for CO₂ to penetrate (Kamihira *et al.*, 1987; Lin *et al.*, 1993; Dillow *et al.*, 1999).

8.4.3 Treatment of Milk with High-Pressure CO₂

By regulation, Grade A raw milk must contain <100 000 CFU/ml (5 log) bacteria when coming from an individual producer, or < 300 000 CFU/ml (5.5 log) as well as <750 000 SCC/ml (5.9 log) for comingled raw milk. After pasteurization, the numbers must be maintained below 20 000 CFU/ml (4.3 log) (FDA, 2011).

Table 8.2 presents available research on the antimicrobial action of high-pressure CO₂ upon the native microbial flora of raw milk, as well as upon inoculated *P. fluorescens* or different pathogens that may occur in whole or skimmed milk, such as *Listeria monocytogenes*, which was found in up to 7% of raw-milk bulk tanks sampled (Oliver *et al.*, 2009). CO₂ has a deleterious effect on all the bacterial strains investigated but, in all cases, the extent of inactivation changed greatly with the CO₂ pressure,

the temperature, the exposure time, the feed ratio of CO₂ to milk (CO₂ concentration, [CO₂]) that changes the resulting pH, and the mode of dispersion (or absence of mixing) of CO₂ throughout the milk.

Under optimal processing conditions (a well-mixed, continuous process with a high P, T, time, and concentration), sCO₂ treatment can achieve microbial populations reductions that are equal or better than those typically achieved during HTST pasteurization (Werner and Hotchkiss, 2006). For example, treatment of skimmed milk at 15 MPa and 35-40°C with a CO₂/milk feed ratio of 0.33 extends the shelf life to 35 days or more (Di Giacomo *et al.*, 2009). However, under identical processing conditions, the degree of inactivation is always lower in whole milk than in skimmed milk due to the presence of milk fat (Lin *et al.*, 1994; Erkmen, 2001b), and some of the processing parameters must be increased (e.g. longer residence time or higher concentration) in order to pasteurize whole milk to the same extent as skimmed milk.

The mode of mixing CO₂ within the milk can make a tremendous difference in the killing efficacy: for example, at about 6 MPa and 45°C, a 6 log reduction of *Listeria* in skimmed milk was obtained in under one hour in one well-mixed experiment, while the same 6 log reduction required approximately 16 hours in an unmixed experiment where CO₂ diffused slowly through the milk's surface (Table 8.2).

Also very important is the CO₂/milk ratio, or CO₂ concentration, [CO₂]: the pH depression caused by the addition of high-pressure CO₂ to milk, and thereby its killing efficacy, is not only dictated by the CO₂ pressure but also by the amount of CO₂ available to dissolve within the milk. Table 8.2 lists several experiments performed under the exact same (P, T, time) conditions but with different CO₂/milk feed ratios, which resulted in very different levels of inactivation. In addition, keeping the temperature well below 45°C and controlling the milk's pH by adjusting [CO₂] is key to preventing the pH from dropping to 4.6 or lower, which is the isoelectric pH of casein, to prevent precipitation of the casein proteins from the milk.

With the optimal set of operating parameters, the sCO₂ treatment can be considered a *mild* but effective pasteurization process for skimmed milk that imparts a high shelf life while maintaining the organoleptic properties of the fresh untreated product (Section 8.6) (Di Giacomo *et al.*, 2009). The efficacy of the sCO₂ pasteurization process for whole milk could be improved either by using it in combination with HTST or by separating the cream from the raw milk via centrifugation (as is typically done), treating the cream with UHT and the skimmed milk with sCO₂, and reintroducing the cream. This could provide a shelf life of 35+ days without affecting the organoleptic properties of the milk. A validation of the whole process at pilot scale, along with an economic feasibility study, is of course recommended (Di Giacomo *et al.*, 2009).

In the case of the deactivation of spores in milk, treatment with high-pressure CO₂ alone is insufficient (Werner and Hotchkiss, 2006). A combination of hurdles involving pulsed electric field (PEF) prior to CO₂ has been suggested to reduce the spores count in a model glycerol solution: in a first step, PEF is applied with at least 25 KV/cm and 20 pulses, followed by a sCO₂ treatment at 40°C and 20 MPa for 24 hours to effectively reduce the *Bacillus* spores count by at least three orders of magnitude (Spilimbergo *et al.*, 2003a). The application of PEF to milk has been widely studied (Chapter 5).

8.5 Low-Pressure CO₂ Injection (Carbonation) to Extend the Shelf Life of Fluid Milk and Soft Dairy Products

8.5.1 Advantages of Carbonation

Refrigerating raw milk does not prevent the growth of psychrotrophic contaminants, which produce extracellular enzymes that induce lipolysis and proteolysis and affect the quality of milk and dairy products. These enzymes are resistant to heat and are not destroyed by the subsequent thermal pasteurization of raw milk. When the psychrotrophic bacteria count exceeds 10⁶ CFU/ml, the enzymatic activity becomes significant and causes UHT milk to gel, off-flavours to appear in many dairy products and cheese yields to decrease (Muir, 1996; Vianna *et al.*, 2012). In UHT milk, proteolysis from the native milk proteases (e.g. plasmin) or heat-resistant proteases produced by the psychrotrophic bacteria increases the viscosity of the milk and causes the formation of a gel, which spoils the milk (Fox and McSweeney, 1998; Datta and Deeth, 2001). In addition to age gelation, the release of hydrophobic peptides can cause a bitter taste and the breakdown of fatty-acids a rancid flavour, and these sensory defects limit the shelf life of UHT milk (Datta and Deeth, 2001; Vianna *et al.*, 2012).

The injection of low-pressure CO₂ (carbonation) in raw milk is an effective way to inhibit the growth of psychrotrophic bacteria in the raw milk without any loss of quality to extend its shelf life, and also to extend the shelf life of pasteurized milk made from carbonated raw milk (Hotchkiss and Loss, 2006). After the injection or bubbling of small amounts of CO₂, the pH of milk is lowered slightly, to around six, and some of the mechanisms listed in Section 8.3.1 begin to occur. For instance, oxygen above and within the milk is displaced and replaced by CO₂ because CO₂ is more soluble than O₂ both in water and fat. O₂ removal impairs the growth of aerobic bacteria, as well as minimizes some of the oxidation reactions that can degrade the milk (Heyndrickx *et al.*, 2010). The presence of CO₂ especially lengthens the lag phase and generation time of aerobic G⁻ psychrotrophs such as *P. fluorescens* (Hendricks and Hotchkiss, 1997; Vianna *et al.*, 2012) and, consequently, slows the production of proteolytic and lipolytic enzymes by these bacteria (Ma *et al.*, 2003; Martin *et al.*, 2003). After 10 days in refrigerated storage, carbonated raw milk possesses significantly lower free fatty acids and soluble nitrogen contents than uncarbonated controls (Ravindra *et al.*, 2014a), thereby extending its shelf life.

As mentioned already, CO₂ does not hinder all microorganisms equally: certain G⁺ psychrotrophs, such as *Lactobacillus*, appear less affected by milk carbonation (Hendricks and Hotchkiss, 1997). While maintaining precise refrigeration conditions is important to avoid the growth of anaerobic pathogens like *Clostridium botulinum*, *Listeria monocytogenes* and *Yersenia enterocolitica* that may be favoured at high CO₂ concentration (Singh *et al.*, 2012).

Some of the other advantages of the direct addition of CO₂ to milk and soft dairy products include: a high efficacy at low temperature, because CO₂ solubility increases; the preservation of the freshness, appearance, nutrients and organoleptic qualities of the food; the absence of preservatives and contaminants, as CO₂ naturally begins to evaporate from the food as soon as the package is opened; it is a process with low labour and energy costs; the ability to lower the costs of the transport and extend storage of milk and dairy products (Hagemeyer and Hotchkiss, 2011; Singh *et al.*, 2012).

8.5.2 Does CO₂ Treatment Affect the Quality and Functionality of Dairy Products?

Without CO₂, high-pressure treatments have been shown to alter the secondary and tertiary structure and some of the functional properties of proteins (Foegeding and Davis, 2011); however, pressures over 300 MPa are required for such irreversible denaturation (Bertucco and Spilimbergo, 2006). The pressure of the CO₂ being added to milk and dairy products during CO₂ treatment is always well below this value. Nonetheless, CO₂ can affect the milk proteins at much lower pressures due to its acidifying and solvating properties, as it adsorbs onto the casein micelles after dissolution and generates carbonic acid that binds with the calcium ions that internally stabilize the micelles (Dalglish and Corredig, 2012). The injection of CO₂ in milk at low temperature (5–20°C) and pressures up to 0.7 MPa does not cause the proteins to precipitate, even after nine days in storage (Rajagopal *et al.*, 2005). However, the denaturing effect of CO₂ increases with both temperature and pressure, as well as with the volume ratio of CO₂ injected into the milk. Near or above the critical point of CO₂ (near T = 30–40°C and P = 7–10 MPa) and in the presence of a high CO₂ feed ratio, up to 10% (w/w) of CO₂ adsorbs onto the casein micelles (Nakamura *et al.*, 1991) and begins to strip away the calcium ions and cause casein to precipitate (Tomasula *et al.*, 1995). When temperature is increased to 60°C or more at pressures above the critical point, sCO₂ triggers the precipitation of different whey proteins depending on T and P (Bonnaillie and Tomasula, 2012b).

To prevent precipitation of the milk proteins during CO₂ treatment, the temperature of the milk, the CO₂ pressure or the amount of CO₂ injected into the milk must be kept relatively low. For example, the carbonation of raw milk to pH 6.4 (from an initial milk pH value of 6.9) does not trigger protein denaturation or isomerization of the lactose during subsequent pasteurization, nor does it affect the sensory properties of the pasteurized milk; whereas carbonation to pH 6.2–6.0 prior to pasteurization can slightly affect the sensory properties of the milk (Olano *et al.*, 1992). During the chilled storage of milk at 4°C, the pH may be lowered considerably (as low as pH 5.2) by pressurizing milk with CO₂ for up to an hour, without irreversibly affecting any of the physicochemical properties of the milk. The size of the casein micelles and the buffering capacity temporarily decrease upon acidification with CO₂; then, any changes are restored directly after the removal of CO₂ by vacuum and the return to neutral pH, or later during refrigerated storage. Chilled carbonation also does not modify the acid-gelling properties of milk (Guillaume *et al.*, 2004a, 2004b; Raouche *et al.*, 2007). Similarly, as CO₂ generates bicarbonate when it dissolves in milk (around pH 6.3, approximately 88% of dissolved CO₂ exists as CO_{2(aq)}, 2% as carbonic acid and 10% as bicarbonate (Hotchkiss *et al.*, 2006)), the salt balance can be modified by the formation of calcium carbonate and other salts, but the salts re-dissolve and the concentrations of inorganic phosphate, calcium and magnesium return to normal after degassing and neutralization of the pH (Olano *et al.*, 1992; Guillaume *et al.*, 2004a, 2004b).

The organoleptic qualities of milk also seem to be preserved during CO₂ processing. Many sensory studies have shown that different CO₂-treated fruit juices were indistinguishable from their untreated counterparts (Gunes *et al.*, 2005; Kincal *et al.*, 2006; Ferrentino *et al.*, 2009) and that the CO₂-treated juices generally retained more ascorbic acid, anthocyanins, soluble phenolics and antioxidant compounds during refrigerated storage than thermally pasteurized juices (Garcia-Gonzalez *et al.*, 2007). At the moderate temperatures used to treat milk with CO₂, it is also expected that the vitamins

will not be damaged. Di Giacomo *et al.* (2009) contacted milk with CO₂ at P = 15 MPa and T = 35–38°C for 15 minutes using a CO₂-to-milk feed ratio of about 0.3, then submitted the milk to an organoleptic panel of experts daily during refrigerated storage. The panel deemed the sCO₂-treated milk satisfactory for up to 35 days, and consistently better-tasting than HTST-pasteurized milk of the same age. However, when the CO₂ pressure is increased, CO₂ tends to extract more aroma compounds from the milk during depressurization and can damage the organoleptic properties (Di Giacomo *et al.*, 2009).

8.5.3 Carbonated Raw Milk

Adding CO₂ to refrigerated raw milk could be an effective and affordable method to extend cold milk storage at the farm or processing plant, as well as to ship raw milk over long distances. Regular raw milk can only be stored for a couple of days prior to pasteurization before spoilage of the milk and off-flavours begin to appear. On the contrary, carbonating raw milk extends its refrigerated (4–7°C) shelf life to more than six days by slowing the growth of psychrotrophic bacteria and, thereby, lipolysis and proteolysis (Rowe, 1989; Sierra *et al.*, 1996). The shelf life of raw milk is measured by its total microbial count and compared to the maximum allowable value of 5.5 log CFU/ml prior to pasteurization for Grade A raw milk and 4.3 log CFU/ml after pasteurization (FDA, 2011); milk is considered spoiled when the total bacterial count passes these limits. The introduction of up to 60 milli-mole (mM) of food-grade CO₂ into raw milk (or up to 1500 ppm), by bubbling for several minutes, or by holding the milk under a low-pressure CO₂ atmosphere (up to 0.7 MPa), is an effective way to increase its shelf life to six days or more. The dissolution of CO₂ lowers the pH to preferably 6.0–6.2 to effectively inhibit the growth of native microorganisms in raw milk as well as psychrotrophic bacteria, such as *Pseudomonas*. After six days at 4°C, Vianna *et al.* (2012) noted that the standard plate count (SPC) of carbonated milk (3.51 log CFU/ml) was almost unchanged from that of the starting raw milk (3.45 log CFU/ml) and much lower than that of untreated milk samples (6.44 log CFU/ml). After six days, CO₂-treated milk still qualified for Grade A standard whereas untreated milk spoiled (Vianna *et al.*, 2012). Rajagopal *et al.* (2005) similarly showed that the refrigerated (4°C) shelf-life of Grade A raw milk can be doubled from four to eight days before the SPC reaches 4.30 log CFU/ml (Rajagopal *et al.*, 2005), the maximum allowable limit for pasteurized milk. Using high-quality raw milk (i.e. with a low initial SPC and SCC), a shelf life of up to 14 days can be obtained at 4°C (Ma *et al.*, 2003).

In addition to keeping the SPC of refrigerated raw milk low, carbonation effectively inhibits the growth of different inoculated microorganisms for an extended period. In carbonated raw milk refrigerated at 6°C and inoculated with *C. Botulinum* spores, the botulinal toxin that causes botulism was not detected in any of the treated samples even after 60 days and *C. Botulinum* did not grow. The SPC was lower than in control samples and decreased with increasing CO₂ concentration (Glass *et al.*, 1999). Similar observations were made with milk inoculated with *B. cereus*, with neither kill nor growth after 35 days at 6°C (Werner and Hotchkiss, 2002). Above refrigeration temperature (15°C), CO₂ is able to reduce and delay the growth of native raw milk bacteria, as well as single strains inoculated into sterilized milk, by up to 24 hours depending on the CO₂ concentration (Martin *et al.*, 2003). *P. fluorescens*,

E. coli, *L. monocytogenes*, *E. faecalis*, *B. cereus* and *B. licheniformis* are successfully inhibited by CO₂, or even killed; the strongest effects were observed on G- bacteria, with a strong reduction of *E. faecalis* and an almost complete kill of *E. coli* after several days at 50 mM CO₂ (Martin *et al.*, 2003).

Although it lowers the pH and the freezing point of milk, low-pressure CO₂ treatment does not affect the physicochemical and nutritional qualities of refrigerated raw milk but, on the contrary, preserves the various components of milk better than refrigeration alone. Untreated raw milk typically suffers fast enzymatic lipolysis and proteolysis and develops off-flavours during transport and storage (Vianna *et al.*, 2012); dissolved CO₂ reduces the microbial growth and production of microbial proteases, as well as the microbial-induced lipolysis, and the acidic pH deactivates alkaline protease enzymes such as plasmin (Ma *et al.*, 2003). After six days at pH 6.0–6.2 and 4–7°C, CO₂-treated milk contains less free fatty acids, indicating less lipolysis, than untreated milk, and the total proteins, casein and whey proteins contents are not affected by the carbonation or the subsequent vacuum applied prior to pasteurization (Vianna *et al.*, 2012). The vitamins are also retained better than in untreated milk, including all-*trans*-retinol, beta-carotene, α - and γ -tocopherol, riboflavin, 13-*cis*-retinol and thiamin (Sierra *et al.*, 1996), and very little to no change occurs to the milk fat and sugar contents, as well as to the sensory and biochemical properties during the length of storage (Ruas-Madiedo *et al.*, 1996a, 1998b, 2000) when CO₂ levels below 40 mM are used (Wang and Li, 2007).

The process to inject CO₂ into raw milk may include sparging into the milk line, or bubbling into the storage silos through a suitable gas-sparging system fitted at the bottom of the silos. Before pasteurization, the milk should then be degassed under vacuum or by sparging a flowing stream of nitrogen gas into the milk (Ruas-Madiedo *et al.*, 1996b; Rajagopal *et al.*, 2005; Hotchkiss *et al.*, 2006; Hagemeyer and Hotchkiss, 2011) to minimize the build-up of deposits on the walls of the pasteurizer (Calvo and De Rafael, 1995).

8.5.4 Carbonated Pasteurized Milk

In general, the shelf life of HTST pasteurized milk is limited by the multiplication of heat-resistant (thermoduric) psychrotrophic organisms that were not killed during pasteurization and produce undesirable flavours as they grow (Fromm and Boor, 2004). Adding a very low concentration of CO₂, just below the sensory threshold (e.g. 1.8–3.2 mM), to HTST milk can successfully inhibit the growth of thermoduric psychrotrophic bacteria and extends the shelf life of the milk by 25–200% (Hotchkiss *et al.*, 1999) depending on the CO₂ concentration and the storage temperature: the shelf life is greater at 4°C than at 6–7°C and with more CO₂ (Hotchkiss *et al.*, 1999). CO₂ can prevent heat-resistant spores from germinating during extended milk storage, such as *B. cereus* spores, which are commonly found in milk and milk-based products (Bartoszewicz *et al.*, 2008) and are extremely thermoduric (Novak *et al.*, 2005; Luu-Thi *et al.*, 2014). If they germinate and grow, *B. cereus* spores can trigger proteolysis and lipolysis of the milk and cause coagulation and off-odours, as well as produce toxins that cause either emetic or diarrhoeal food-borne illness (Lindbäck and Granum, 2013). The addition of low-pressure CO₂, although it extends the shelf life of HTST milk, does not promote the germination and growth of *B. cereus* or *C. botulinum* spores over long-term storage (35–60 days), as described in Section 8.5.3, and does not increase the risk of food-borne illness.

The pretreatment of raw milk with CO₂ before thermal pasteurization increases the microbial kill efficacy proportionally to the CO₂ concentration, and exponentially with temperature. According to Loss and Hotchkiss (2002), at 63°C the addition of 22 mM of CO₂ to raw milk did not significantly reduce the SPC compared to heat only; the observed survival curves were identical and typical of the thermal inactivation of heterogeneous microbial populations: a rapid initial decrease in counts corresponding to thermally sensitive microorganisms, followed by a slow 1 log reduction over 40 minutes, corresponding to thermoduric ones. However, higher CO₂ concentrations (44 mM) considerably lowered the final SPC after pasteurization at higher temperatures (67–93°C) compared to heat treatment alone (Loss and Hotchkiss, 2002). Microbial species are more or less sensitive to the combination of carbonation and pasteurization; for example, *P. fluorescens* inoculated to milk pretreated with 36 mM CO₂ shows a 5 log reduction after heating for 35 minutes at 50°C, but *B. cereus* spores are barely affected after 25 minutes at 89°C, with less than a 0.3 log improvement compared to heat-treated controls only (Loss and Hotchkiss, 2002). The point at which CO₂ is injected into the pasteurization line may also have an effect on the microbial kill. For example, CO₂ could be added during come-up time in the regeneration section, just ahead of the holding tube, or under pressure during homogenization (Loss and Hotchkiss, 2002).

One problem with acidifying milk with CO₂ prior to pasteurization is the formation of twice as much protein deposits on the heat-exchanger walls, if CO₂ is not vacuum degassed before heating (Calvo and De Rafael, 1995), which also leads to changes in the proportions of carbohydrates and milk proteins (Olano *et al.*, 1992).

In UHT-pasteurized milk, pre-acidification with CO₂ to pH 6.2 (about 1000 ppm), followed by degassing, reduces the activity of plasmin, the growth of psychrotrophic bacteria and the production of heat-stable microbial proteases before pasteurization, which slows lipolysis and proteolysis after UHT pasteurization. The rate of proteolysis becomes 1.4 times slower than in the untreated control, which may help delay the age-gelation of UHT milk (Vianna *et al.*, 2012). Pretreatment with CO₂ does not negatively alter the physicochemical characteristics of UHT milk and may further extend its shelf life. In addition, the lower rate of lipolysis improves the flavour of the milk by slowing the production of short- and medium-chain length free fatty acids with a strong undesirable flavour (Deeth, 2006).

8.5.5 Cottage Cheese

Cottage cheese is commercially treated with CO₂ to prolong its shelf life. To inhibit the growth of psychrotrophs both on the surface and within the depth of the cheese, cottage cheese containers are flushed with CO₂ before filling, CO₂ is added throughout the cheese or the cream dressing by bubbling, then the headspace is again flushed with CO₂. A concentration of 10 mM CO₂ does not affect the pH or flavour (Moir *et al.*, 1993). To take maximum advantage of the carbonation, cottage cheese must be packaged in CO₂-tight containers: conventional polystyrene or polyolefin plastic tubs are highly permeable to CO₂ and the CO₂ content decreases rapidly during storage (Moir *et al.*, 1993) and conventional friction lids are not airtight and offer little resistance to outgassing. To maintain the initial CO₂ level during storage of the cheese, both the tub and seal over the opening must be good CO₂ barriers; or, the standard polystyrene container can be shrink-wrapped with a high-barrier film (Hotchkiss *et al.*, 2006). For

example, carbonated cottage cheese containers packaged inside a 2.3 kg high-barrier polymer bag are able to maintain their initial CO₂ concentration for at least 29 days at 4°C, with a reduced rate of microbial growth through the cheese (Lee and Hotchkiss, 1997), including that of *Listeria monocytogenes* (Chen and Hotchkiss, 1993). The addition of a high-barrier heat-shrinkable film to the container can preserve the quality of the cheese for up to 42 days at 7°C or 63 days at 4°C, giving cottage cheese a refrigerated shelf life of up to nine weeks, compared to three weeks without carbonation (Chen and Hotchkiss, 1991).

Commercially, low-pressure CO₂ can be injected into the cream dressing of cream-style cottage cheese via an in-line sparging unit designed for food applications. Several parameters to control include: the size of the CO₂ bubbles, the temperature, the backpressure and residence time in the line, and the filling process (Hotchkiss and Lee, 1996).

8.5.6 Yogurt

Although Choi and Kosikowski (1985) indicated that the addition of CO₂ to sweetened drinkable yogurt with 50 kPa of CO₂ at 4°C extended its sensory acceptability and shelf life from 30 days to 120 days, subsequent studies showed a negligible preservative effect of carbonation in both drinkable and spoonable yogurt. As much as 1450 ppm (33 mM) of CO₂ can be dissolved in simulated spoonable yogurt in refrigerated milk (3.3°C), or 966 ppm (22 mM) at 17°C, before the incorporation of excess CO₂ generates bubbles and foam (Taylor and Ogden, 2002); however, the threshold for the sensory detection of carbonation in yogurt is only around 300 ppm (6 mM) (Wright *et al.*, 2003). The acidification of various spoonable or drinkable flavoured yogurts with low levels of CO₂ (for example, by bubbling at 8 kPa, or holding under 200 kPa for two hours) did not significantly alter their sensory characteristics nor affect their acceptability by expert panelists and consumers (Karagul-Yuceer *et al.*, 1999); it did not inhibit or kill yogurt starter and probiotic bacteria, nor did it affect the growth of inoculated pathogenic organisms during up to 90 days in refrigerated storage (4°C) (Karagul-Yuceer *et al.*, 2001; Walsh *et al.*, 2014).

If yogurt is manufactured from raw milk pretreated with CO₂ at pH 6.2 and 4°C and stored at 4°C before pasteurization, both the growth of the starter cultures and the sensory properties of the yogurt are equally unaffected (Calvo *et al.*, 1999; Gueimonde *et al.*, 2003), or may be slightly better than in control yogurt from untreated milk; for example, plain and probiotic yogurts made from CO₂-treated milk and containing *Lactobacillus delbrueckii ssp. Bulgaricus* and *Streptococcus thermophilus*, or *Lactobacillus acidophilus*, had a slightly fresher taste, firmer texture, lower syneresis (i.e. whey separation) and higher overall acceptability than control yogurts (Ansari *et al.*, 2013).

8.5.7 Fermented and Flavoured Dairy Beverages

Ravindra *et al.* (2014a, 2014b) investigated the carbonation of flavoured dairy beverages, both fermented and unfermented, under 70–600 kPa of CO₂ for 10–120 seconds, using a soda-bottle carbonation set-up. Treatment under about 350 kPa of CO₂ for 30 seconds appeared optimal to slow the growth of psychrotrophs and extend the shelf life of dairy beverages without reducing their acceptability by test consumers.

Flavoured dairy drinks became more acidic after carbonation at 15°C before refrigeration, with a barely detectable fizz that did not affect the sensory properties negatively (colour and appearance, flavour, texture and overall acceptance) but significantly reduced the free fatty acids and soluble nitrogen contents after 10 days of refrigeration and extended the acceptable shelf life from 14 to 30 days (Ravindra *et al.*, 2014a). Sweetened lassi drinks fermented with *Lactococcus lactis* and carbonated at 7°C had a more marginal pH reduction but significantly less proteolysis and less lipolysis than control samples with no adverse impact on their sensory quality. The carbonation inhibited the growth of yeasts and moulds during refrigerated storage and extended the shelf life of fermented lassi drinks from five weeks to up to 12 weeks (Ravindra *et al.*, 2014b). In probiotic beverages such as ABT or AT fermented milks (*Lactobacillus acidophilus*/*Bifidobacterium bifidum*/*Streptococcus thermophilus* or *L. acidophilus*/*S. thermophilus*), carbonating the milk can accelerate fermentation, with no detrimental effects on the sensory properties of the product or on the probiotic starter cultures. The higher acidity level of CO₂-treated milk may enhance the growth and metabolic activity of some probiotic cultures; for example, the lag phase of many *L. acidophilus* strains decreases, while the acidification capacity of some *S. thermophilus* strains increases, which shortens the time needed to reach pH 5 (Vinderola *et al.*, 2000; Gueimonde and de los Reyes-Gavilan, 2004). At the same time, CO₂ inhibits the growth of some inoculated pathogens, such as *B. cereus* (Noriega *et al.*, 2003); therefore, carbonation could be an effective method to reduce the manufacturing time for probiotic-fermented milks while minimizing the risk of *B. cereus* contamination.

8.5.8 Butter, Sour Cream and Ice Cream

CO₂ is highly soluble in lipids and can be added to butter by churning under a CO₂ atmosphere to let it blend with the cream during the entire churning operation. If the butter is packaged in airtight vessels, CO₂ suppresses microbial growth (Prucha *et al.*, 1925) and may also reduce the degradation of riboflavin and carotenoids (yellow colour) due to light during storage (Juric *et al.*, 2003). The butter has a slightly sour initial taste.

With ice cream mixes and sour cream, the injection of up to 1000 ppm CO₂ can increase the shelf life by 75–125% when packaged in a high-barrier container, by slowing the enzymatic breakdown and the oxidation of fats. This would facilitate the transport from the production plant to the processing plant, where CO₂ will evolve and will, therefore, not affect the sensory properties of the ice cream (Henzler and Paradis, 1997).

8.6 Other Dairy-Related Applications for CO₂

8.6.1 Fractionation of Milk Lipids

Owing to its nonpolar solvent properties, supercritical CO₂ can solvate some of the lipids present in the complex mixture that constitutes milk fat, which evolves during the storage and aging of dairy products due to fat oxidation and enzymatic lipolysis. Generally, nonpolar lipids with shorter chain and small, volatile organic molecules are

soluble in sCO₂ to different degrees depending on T, P, CO₂ concentration and time, while polar and larger lipids are less soluble. Depending on the processing conditions and the type of dairy product treated, sCO₂ can remove volatile off-flavours and/or extract different fractions of the lipids to produce lower-fat products with a more pleasant aroma profile. Dried whey ingredients, such as whey protein isolate (WPI) powders, treated with sCO₂ at 7.5 MPa and T $\geq 35^{\circ}\text{C}$ for at least 30 minutes contain less volatile off-flavours than are generated during the oxidation of their small lipids fraction during storage. Compounds extracted by sCO₂ include short-chain aldehydes, methyl ketones, alcohols and free fatty acids, which possess sour, brothy, diacetyl, cucumber-like, cabbage-like, and fatty/oxidized aromas that are disliked by consumers. Removing these off-flavours produces blander whey protein mixtures that are more versatile food ingredients (Llonillo-Lamsen and Zhong, 2011). At higher pressure (20–35 MPa) and high CO₂ concentration, some nonpolar triglycerides and free fatty acids in hard cheeses, such as Cheddar and Parmesan, become extracted with sCO₂ at the same time as more volatile compounds, while the polar lipids, such as phospholipids, remain in the cheese matrix. The resulting cheeses can have up to about 50% less fat and have less off-flavours, which may also highlight some of the more pleasant aromas of the cheese compared to its commercial full-fat or reduced-fat counterparts (Yee *et al.*, 2007). With anhydrous milk fat powder, changing the pressure and temperature of the sCO₂ process changes the solubility of the medium- and long-chain fatty acids in the extracted sCO₂ phase, whereas the short-chain fatty acids readily dissolve at low pressure. Depending on P (up to 36 MPa) and T (40–60°C), two separate milk fat fractions are obtained in the sCO₂ extract and the remaining powder, with different ratios of longer-chain to short-chain fatty acids and, therefore, different average molecular weights, melting temperatures, iodine and colour values, that can be used as new ingredients for food or bio-based materials (Spano *et al.*, 2004; Büyükbeşe *et al.*, 2014).

When the desired extraction products are free fatty acids, the addition of an enzyme like Lipozyme can accelerate the lipolysis of triglycerides (TGs) into diglycerides (DGs), monoglycerides (MGs) and free fatty acids (FFAs). A particular FFA of interest is conjugated linoleic acid (CLA), which is associated with numerous health benefits. The production and recovery rate of different FFAs into the sCO₂ phase depends on the type and amount of solvent mixed with the milk fat (water or ethanol), as well as the sCO₂ temperature and pressure during and after lipolysis. Using a milk fat:water ratio between 1:5 and 1:30 under 23–30 MPa CO₂ at 55°C, Prado *et al.* produced either a high yield of total FFA (up to 86.79 %) or a high CLA/FFA ratio (up to 6.81 mg/g) depending on the conditions (Prado *et al.*, 2012). At lower pressure, following partial lipolysis with extraction by near-critical CO₂ in the presence of an alcohol (e.g. ethanol) as an extraction enhancer, it is possible to extract the short-chain fatty acid ethyl esters (natural flavour agents) and leave behind a diacylglycerol-based, potentially superior dietary fat (Lubary *et al.*, 2010; Kaneno *et al.*, 2011).

Beta-serum, a water-in-oil emulsion from dairy streams that contains >60% milk fat, may also be fractionated with sCO₂ at 30 MPa and 40°C, followed by another solvent (e.g. dimethylether (DME) at 4 MPa at 60°C), to produce three new functional food ingredients: in sCO₂, a nonpolar lipid extract containing free fatty acids, cholesterol, β -carotene and some triglycerides; in DME, a polar lipid extract enriched with phospholipids (about 70%); and a defatted lactose/protein powder (Catchpole *et al.*, 2008).

8.6.2 Manufacture of Cheese from CO₂-Treated Milk

For cheese manufacturing, carbonating cow's or ewe's milk before or after pasteurization for different lengths of time (from a few minutes to a few days) helps preserve milk before use. It also appears to have a positive impact on the cheese making process and the quality and shelf life of different cheeses, whether the CO₂ is removed prior to cheese making or not. The impact of CO₂ on the cheese attributes and the cheese making process depends on the type of cheese and the amount of CO₂ added to acidify the milk prior to cheese making. Different acidification levels (from pH 6.55 to 4.8) have been studied to identify the effects of CO₂ on the casein proteins and micelles and its influence on enzymatic proteolysis and clotting, water and salt retention in the cheese, microorganisms growth during aging and so on. Low levels of CO₂ injected in milk cause small pH reductions that do not permanently affect the structure of the casein micelles if CO₂ is subsequently removed (Guillaume *et al.*, 2004b) but have a considerable effect on the casein–rennet interactions while CO₂ is present. For example, milk lightly acidified to pH 6.55 (initial pH 6.67) with CO₂ immediately after pasteurization requires 30% less rennet than untreated milk to coagulate, similarly to the effects of lactic acid, while the manufacturing time is reduced and fat recovery increases (St-Gelais *et al.*, 1997). When larger amounts of CO₂ are injected after pasteurization (Nelson *et al.*, 2004b), the casein micelles may undergo irreversible changes that further accelerate enzymatic coagulation, and can considerably increase the yield of the cheese making process.

After carbonating refrigerated milk at pH 5.2 or 4.8 with 0.55 or 2 MPa of CO₂ for 15 minutes, and then degassing the CO₂, Guillaume *et al.* observed some irreversible changes in the casein micelles and some of the milk's properties, and postulated that CO₂ caused a reorganization of the colloidal calcium-phosphate and carboxylic groups internal to the micelles, which consequently rearranged the micelles' surface and increased their surface reactivity (Guillaume *et al.*, 2004a). For instance, the release of glycomacropeptide during cheese making accelerated, suggesting a greater accessibility of κ -casein to rennet (Guillaume *et al.*, 2004a). As a result, pre-acidification of milk with CO₂ considerably increases the efficiency and yield of the cheese making process by reducing the amount of rennet needed for coagulation (Montilla *et al.*, 1995; Nelson *et al.*, 2004b), shortening the clotting time (Ruas-Madiedo *et al.*, 2002; Nelson *et al.*, 2004b) and improving and accelerating firming of the curds and separation of the whey (Ruas-Madiedo *et al.*, 2002). In addition, cheese yields may also increase through better water retention, while less salt needs to be used (Nelson and Barbano, 2005). These effects tend to be emphasized when the CO₂ concentration increases.

In general, the physical and organoleptic qualities of cheeses manufactured from milk pretreated with CO₂ were not negatively affected and their shelf life was improved. Cheeses such as traditional Cheddar, young (30-day) and aged (75-day) hard Spanish cheeses (90% cow's/10% ewe's milk), and brined cheeses ('Turkish White' variety) were successfully produced and compared with control cheeses made from untreated raw or pasteurized milk (Ruas-Madiedo *et al.*, 2002; Nelson *et al.*, 2004a, 2004b; Dertli and Akin, 2008). During cheese making, modification of the casein micelles by CO₂ increased both moisture retention (i.e. less whey) and salt uptake by the curds during the salting-and-pressing stage of cheddar cheese (Guillaume *et al.*, 2004a; Nelson and Barbano, 2005), reducing the salt needed by about 30% to obtain the same salt content in the cheese. Salt and whey reduction

both diminish processing waste. In addition, cheddar from CO₂ pretreated milk had a lower whey pH (5.93 versus 6.35), lower fat content and lower calcium content, which reduced the formation of crystals in the cheese (Nelson *et al.*, 2004a, 2004b).

With short-ripened cheese coagulated by lactic acid, CO₂ pretreatment of both raw and pasteurized milk did not affect the growth and activity of lactic acid bacteria, nor the production of volatile compounds during cheese making and ripening; however, residual CO₂ slowed proteolysis during the first few days of ripening. After 15 days (the optimum time for consumption), differences in proteolysis or sensory properties between cheeses from CO₂-treated milk and control milk were either not detectable, or considered acceptable (Ruas-Madiedo *et al.*, 1998a, 2002). CO₂ pretreatment also slowed proteolysis and lipolysis during aging of cheddar cheese, possibly due to the lower amount of rennet employed to coagulate the milk. After one or two months of aging, no significant differences in sensory attributes were perceived (St-Gelais *et al.*, 1997). With brined cheeses, the preliminary carbonation of milk provided lower bacterial counts and significantly less yeasts and moulds in the cheese after 90 days of maturation, and bacterial inactivation increased with the amount of CO₂ injected in the milk (Dertli *et al.*, 2012).

When large amounts of CO₂ are injected into milk at high pressure *during* the cheese making process (after inoculated milk with the cheese starter cultures), the strong acidification effect of CO₂ causes the casein micelles to precipitate and can greatly accelerate the production of cheese curds, provided that the cheese starter cultures survive this processing step (Van Hekken *et al.*, 2000). While CO₂ has strong antimicrobial effects on psychrotrophic bacteria, it is less detrimental to the facultative anaerobic lactic acid bacteria commonly used in cheese making. After short, five-minute exposures to 5.5 MPa of CO₂ at 38°C, thermophilic and mesophilic starter cultures such as *L. bulgaricus*, *L. Lactis* and *S. thermophilus* (inoculated at about 7 log CFU/ml) survived the process well; while *L. bulgaricus* was reduced by 1–1.5 log CFU/ml in the curd, *L. Lactis* and *S. thermophilus* were mostly unaffected by the CO₂ treatment. High-pressure carbonation after inoculation of milk with starter cultures can greatly reduce the time needed for cheese making, to minutes instead of the hours currently required.

8.6.3 Fractionation of Milk Proteins

At high concentration and moderate-to-high temperatures (40–80°C), supercritical CO₂ blended with milk or dairy protein solutions can denature, destabilize and cause some of the dairy proteins to precipitate, owing to its combined acidifying and anti-solvent activity. As described earlier, sCO₂ forms carbonic acid when dissolving in an aqueous solution and lowers the pH, which may change the ionic and electrostatic interactions within the casein micelles and the whey proteins (WP) and cause shifts in the tertiary and/or secondary structure of some of the proteins, triggering agglomeration and precipitation (Bonnaillie and Tomasula, 2008). Concentrated, solvated CO_{2(aq)} also acts as an anti-solvent and can further destabilize milk proteins suspended in water and accelerate the precipitation of a fraction of the proteins. This effect amplifies when the CO_{2(aq)} concentration in the milk or WP solution is raised by increasing the feed ratio of sCO₂ to the solution, blending sCO₂ with the milk/solution and raising the pressure. In a batch high-pressure reactor, sCO₂ can be well mixed by using a turbine impeller that collects sCO₂ from the headspace of the

reactor and continually sparges it at the bottom of the solution, while at the same time generating turbulent agitation. When $s\text{CO}_2$ is blended well, the thermodynamic and kinetic equilibriums (i.e. stable pressure and pH) are reached within minutes of injecting CO_2 into the solution (Yver *et al.*, 2011). Tomasula, Bonnaillie and others (1995–2014) have extensively studied the pilot scale fractionation of milk and WP solutions with $s\text{CO}_2$ using a one-litre high-pressure stirred batch reactor to blend milk or concentrated WPC (whey protein concentrate) and WPI solutions with 8–31 MPa of $s\text{CO}_2$. Sample sizes ranged from 500 to 800 g, leaving a headspace of about 500–200 ml for $s\text{CO}_2$; if milk and protein solutions are not compressible, this volume corresponds to a mass of about 25–250 g of $s\text{CO}_2$ at 60°C (according to the ideal gas law), that is a $\text{CO}_{2(\text{aq})}$ concentration of about 3–33% (w/w) if $s\text{CO}_2$ is well blended with the solution.

The different proteins of milk have different stability and solubility in milk and solutions. The combined effects of temperature (T), $s\text{CO}_2$ pressure (P) and concentration can be used to trigger the sequential denaturation and precipitation of the milk proteins: casein agglomerates and precipitates from milk around about 38–40°C and 7 MPa of $s\text{CO}_2$ to form CO_2 -casein (Jordan *et al.*, 1987; Tomasula, 1995; Tomasula *et al.*, 1995; Hofland *et al.*, 1999), while the whey proteins remain soluble. Up to 55°C and 8 MPa, the precipitation of the whey proteins is almost nonexistent; when P and T increase further, concentrated WP solutions (WPC or WPI) begin to agglomerate and fractionate, with α -lactalbumin (α -LA), lactoferrin, bovine serum albumin and immunoglobulins precipitating around 60–65°C and 8–31 MPa (Tomasula *et al.*, 1998b; Yver *et al.*, 2011; Bonnaillie and Tomasula, 2012b), and β -lactoglobulin (β -LG) precipitating mostly around 70–80°C and 31 MPa (Bonnaillie *et al.*, 2014). The caseino-maclopeptides (also called glycomaclopeptide, GMP) remain soluble on the entire range of T and P studied (Bonnaillie and Tomasula, 2012a). In a sequential process, $s\text{CO}_2$ could enable the extraction of casein from skimmed milk, followed by filtration and concentration of the whey, followed by the fractionation of the concentrated WPC or WPI solution with a one- or two-stage process to yield up to four different whey protein products, such as a powdered fraction enriched in α -LA or β -LG, a β -LG isolate, and a GMP isolate (Bonnaillie and Tomasula, 2012a, unpublished work).

The kinetics of denaturation and precipitation of casein and of the different whey proteins depend greatly on the pH, temperature and concentration (C) of the protein solution (Tomasula *et al.*, 1995; Hofland *et al.*, 2003; Bonnaillie and Tomasula, 2012c). Therefore, the various parameters governing the CO_2 -fractionation process (including C, P, T, time and the CO_2 feed ratio) must be adjusted carefully to produce the desired casein particles size, or WP fractions that are optimally enriched with one protein or another. Generally, because both the product yields and the processing and equipment costs increase with CO_2 pressure and temperature, it is important to keep in mind the economic aspects and technical feasibility of the process (Tomasula, 1995; Tomasula *et al.*, 1997, 1998a; Yver *et al.*, 2011; Bonnaillie *et al.*, 2014). Several patents have been granted for processes that use $s\text{CO}_2$ to produce casein from milk (Kollmann *et al.*, 2003) or to fractionate concentrated WPC or WPI (Tomasula and Parris, 1999), as well as a process for the continuous removal of products, such as CO_2 -casein, from high-pressure systems (Tomasula, 1995).

Contrarily to milk proteins precipitated with organic or mineral acids or other solvents, casein and WP fractions produced with $s\text{CO}_2$ have a neutral pH after CO_2 vaporizes and are free of any contaminants. CO_2 -casein and the various WP fractions

that can be obtained are new ingredients that can be incorporated into a variety of specialty food and nonfood items. For example, enriched α -LA could enhance nutritious foods for infants and the elderly; enriched β -LG and β -LG isolate are ideal for sports nutrition and gelling applications; and, GMP does not possess the phenylalanine amino acid and could be a source of protein for phenylketonuria patients who cannot metabolize phenylalanine. GMP is also 100% soluble and resistant to heat and low pH and, therefore, ideal for beverage applications.

Compared to commercial acid-precipitated casein, CO_2 -casein is less water soluble (Strange *et al.*, 1998) and edible films and food coatings manufactured from it are less susceptible to high humidity environments. The appearance and physical properties of edible CO_2 -casein films can be customized by adjusting the parameters of the s CO_2 process, or grinding the CO_2 -casein to reduce its particle size: larger particles produce hazy but strong and water-resistant films, while smaller particles yield clearer, weaker and more hydrophilic films. The films may be selected depending on the targeted food, nonfood or packaging applications (Tomasula *et al.*, 1998c, 2003; Parris *et al.*, 2001; Tomasula, 2002; Kozempel and Tomasula, 2005; Dangaran *et al.*, 2006).

8.7 Regulatory Status

Although the benefits of CO_2 to the dairy industry are clear and there are abundant data supporting its use to improve the microbial quality of raw milk, high-pressure CO_2 treatment or the incorporation of CO_2 to milk are not yet permitted. Carbon dioxide is generally recognized as safe (GRAS) when used in accordance with good manufacturing or feeding practice¹ by the US Food and Drug Administration (FDA) and its addition to food is accepted for use as a leavening agent, a processing aid or a propellant or aerating agent². CO_2 must be 'Food Grade' or 'USP', which must be inscribed on its container or stated in a letter from its manufacturer. The practice of incorporating CO_2 into cottage cheese to extend its shelf life has been accepted for many years. If CO_2 is used as headspace filler, it is considered a processing aide and does not require any additional labelling³. However, when incorporated directly into the product, CO_2 needs to be identified in the ingredient list as 'carbon dioxide' followed by '(preservative)' or '(extends shelf life)'⁴.

For fluid milk, CO_2 introduced into the head space during packaging is not considered an ingredient by the FDA (as of January 2007) and does not violate the standard of identity for 'milk' and does not have to be labelled. Conversely, incorporating and retaining CO_2 into bulk shipments of fluid milk products via sparging, injection and so on, is not allowed per the standard of identity for 'milk': the FDA would consider CO_2 to be an ingredient and the product would not comply with the standard and, therefore, could not be labelled as 'milk'. Similarly, the standards of identity for concentrated milk, cream and other milk products do not yet provide for the incorporation of CO_2 ⁵.

¹ 21CFR582.1240: Code of Federal Regulations Title 21, Volume 6, Sec. 582.1240.

² 21CFR184.1240: Code of Federal Regulations Title 21, Volume 3, Sec. 184.1240.

³ 21CFR101.100: Code of Federal Regulations Title 21, Volume 2, Sec. 101.100 Food; exemptions from labeling, (a)(3)(ii).

⁴ 21CFR101: Code of Federal Regulations Title 21, Volume 2, Part 101 Food labeling.

⁵ 21CFR131: Code of Federal Regulations Title 21, Volume 2, Part 131, Milk and Cream.

Acknowledgements

The authors thank Dr John Renye for valuable discussions and critical review of sections of this chapter.

References

- Ansari, T., J. Hesari, et al. (2013). Effects of CO₂ Addition to Raw Milk on Microbial, Physiochemical and Sensory Properties of Probiotic Set Yoghurt. *J Agric Sci Tech*, **15**(2): 253–263.
- Barbano, D.M., Ma, Y. and Santos, M.V. (2006) Influence of raw milk quality on fluid milk shelf life. *J Dairy Sci*, **89**(Suppl. 1): E15-E19.
- Barbano, D.M. and Boor, K.J. (2007) Breaking the 21 to 28 day shelf-life barrier on refrigerated htst pasteurized milk. *J Dairy Sci*, **90**(Suppl. 1): 184–185.
- Bartoszewicz, M., Hansen, B.M. and Swiecicka, I. (2008) The members of the *Bacillus cereus* group are commonly present contaminants of fresh and heat-treated milk. *Food Microbiol*, **25**(4): 588–596.
- Bertucco, A. and Spilimbergo, S. (2006) Food pasteurization and sterilization with high pressure. In: *Functional Food Ingredients and Nutraceuticals* (ed. J. Shi). CRC Press, pp. 269–295.
- Bonnaillie, L.M. and Tomasula, P.M. (2008) Whey protein fractionation. In: *Whey Processing, Functionality and Health Benefits* (eds C.I. Onwulata and P.J. Huth). IFT Press Series, John Wiley & Sons, Inc., Hoboken, NJ, pp. 15–38.
- Bonnaillie, L.M. and Tomasula, P.M. (2012a) Sequential fractionation of milk and whey proteins with supercritical carbon dioxide for new health-promoting food ingredients. *International Symposium on Supercritical Fluids*, San Francisco, CA.
- Bonnaillie, L.M. and Tomasula, P.M. (2012b) Fractionation of whey protein isolate with supercritical carbon dioxide to produce enriched α -lactalbumin and β -lactoglobulin food ingredients. *J Agric Food Chem*, **60**(20): 5257–5266.
- Bonnaillie, L.M. and Tomasula, P.M. (2012c) Kinetics, aggregation behavior and optimization of the fractionation of whey protein isolate with hydrochloric acid. *Food Bioprod Proc*, **90**(4): 737–747.
- Bonnaillie, L.M., Qi, P., Wickham, E. and Tomasula, P.M. (2014) Enrichment and purification of casein glycomacropptide from whey protein isolate using supercritical carbon dioxide processing and membrane ultrafiltration. *Foods* **3**(1): 94–109.
- Boor, K.J. and Murphy, S.C. (2002) Microbiology of market milks. In: *Dairy Microbiology Handbook: The Microbiology of Milk and Milk Products*, 3rd edn (ed R.K. Robinson). John Wiley & Sons, Inc., New York, pp. 91–122.
- Brunner, G. (2005) Supercritical fluids: Technology and application to food processing. *J Food En*. **67**(1–2): 21–33.
- Butler, J.N. (1991) *Carbon Dioxide Equilibria and their Applications*. Lewis Publishers Inc., Chelsea, MI.
- Büyükebeşe, D., Emre, E. and Kaya, A. (2014) Supercritical carbon dioxide fractionation of anhydrous milk fat. *J Am Oil Chem Soc*, **91**(1): 169–177.
- Calvo, M.M. and De Rafael, D. (1995) Deposit formation in a heat exchanger during pasteurization of CO₂-acidified milk. *J Dairy Res*, **62**(4): 641–4.

- Calvo, M.M., Montilla, A. and Cobos, A. (1999) Lactic acid production and rheological properties of yogurt made from milk acidified with carbon dioxide. *J Sci Food Agric*, **79**(9): 1208–1212.
- Catchpole, O.J., Tallon, S.J., Grey, J.B. *et al.* (2008) Extraction of lipids from a specialist dairy stream. *J Supercrit Fluids*, **45**(3): 314–321.
- Chambers, J.V. (2002) The microbiology of raw milk. In: *Dairy Microbiology Handbook: The Microbiology of Milk and Milk Products*, 3rd edn (ed R.K. Robinson). John Wiley & Sons, Inc., New York, pp. 39–90.
- Chen, J.H. and Hotchkiss, J.H. (1991) Effect of dissolved carbon dioxide on the growth of psychrotrophic organisms in cottage cheese. *J Dairy Sci*, **74**(9): 2941–2945.
- Chen, J.H. and Hotchkiss, J.H. (1993) Growth of listeria monocytogenes and clostridium sporogenes in cottage cheese in modified atmosphere packaging. *J Dairy Sci*, **76**(4): 972–977.
- Choi, H. and Kosikowski, F. (1985) Sweetened plain and flavored carbonated yogurt beverages. *J Dairy Sci*, **68**(3): 613–619.
- Dalgleish, D.G. and Corredig, M. (2012) The structure of the casein micelle of milk and its changes during processing. *Ann Rev Food Sci Tech* **3**: 449–467.
- Damar, S. and Balaban, M.O. (2006) Review of dense phase CO₂ technology: Microbial and enzyme inactivation, and effects on food quality. *J Food Sci*, **71**(1): R1–R11.
- Dangaran, K.L., Cooke, P. and Tomasula, P.M. (2006) The effect of protein particle size reduction on the physical properties of CO₂-precipitated casein films. *J Food Sci*, **71**(4): E196–E201.
- Daniels, J.A., Krishnamurthi, R. and Rizvi, S.S.H. (1985) A review of the effects of carbon dioxide on microbial growth and food quality. *J Food Protect*, **48**: 532–537.
- Datta, N. and Deeth, H.C. (2001) Age gelation of uht milk – a review. *Food Bioprod Proc*, **79**(C4): 197–210.
- Debs-Louka, E., Louka, N., Abraham, G. *et al.* (1999) Effect of compressed carbon dioxide on microbial cell viability. *Appl Environ Microbiol*, **65**(2): 626–631.
- Deeth, H.C. (2006) Lipoprotein lipase and lipolysis in milk. *Int Dairy J*, **16**(6): 555–562.
- Dertli, E. and Akin, N. (2008) CO₂ application on milk and dairy products – i: General informations. *Gida*, **33**(4): 193–201.
- Dertli, E., Sert, D. and Akin, N. (2012) The effects of carbon dioxide addition to cheese milk on the microbiological properties of turkish white brined cheese. *Int J Dairy Tech*, **65**(3): 387–392.
- Di Giacomo, G., Taglieri, L. and Carozza, P. (2009) Pasteurization and sterilization of milk by supercritical carbon dioxide treatment. Proceedings of the 9th International Symposium on Supercritical Fluids, 18–20 May, Arcachon, France.
- Dillow, A.K., Dehghani, F., Hrkach, J.S. *et al.* (1999) Bacterial inactivation by using near- and supercritical carbon dioxide. *Proc Natl Acad Sci USA*, **96**(18): 10344–10348.
- Dixon, N.M. and Kell, D.B. (1989) The inhibition by carbon dioxide of the growth and metabolism of microorganisms. *J Appl Bacteriol*, **67**: 109–136.
- Enfors, S.-O. and Molin, G. (1981) The influence of temperature on the growth inhibitory effect of carbon dioxide on *pseudomonas fragi* and *Bacillus cereus*. *Can J Microbiol*, **27**(1): 15–19.
- Enomoto, A., Nakamura, K., Nagai, K. *et al.* (1997) Inactivation of food microorganisms by high-pressure carbon dioxide treatment with or without explosive decompression. *Biosci Biotech Biochem*, **61**(7): 1133–1137.

- Erkmen, O. (1997) Antimicrobial effect of pressurized carbon dioxide on *staphylococcus aureus* in broth and milk. *LWT – Food Sci Tech*, **30**(8): 826–829.
- Erkmen, O. (2000a) Effect of carbon dioxide pressure on *listeria monocytogenes* in physiological saline and foods. *Food Microbiol*, **17**(6): 589–596.
- Erkmen, O. (2000b) Antimicrobial effect of pressurised carbon dioxide on *enterococcus faecalis* in physiological saline and foods. *J Sci Food Agric*, **80**(4): 465–470.
- Erkmen, O. (2000c) Antimicrobial effects of pressurised carbon dioxide on *brochothrix thermosphacta* in broth and foods. *J Sci Food Agric*, **80**(9): 1365–1370.
- Erkmen, O. (2001a) Note. Antimicrobial effect of pressurized carbon dioxide on *yersinia enterocolitica* in broth and foods. *Food Sci Tech Int*, **7**(3): 245–250.
- Erkmen, O. (2001b) Effects of high-pressure carbon dioxide on *escherichia coli* in nutrient broth and milk. *Int J Food Microbiol*, **65**(1-2): 131–135.
- FDA (Food and Drug Administration) (2011) Grade ‘A’ pasteurized milk ordinance. US Department of Health and Human Services, Public Health Service. <http://www.fda.gov/downloads/food/guidanceregulation/ucm291757.pdf> (last accessed 7 January 2015).
- Ferrentino, G., Plaza, M.L., Ramirez-Rodrigues, M. *et al.* (2009) Effects of dense phase carbon dioxide pasteurization on the physical and quality attributes of a red grapefruit juice. *J Food Sci*, **74**(6): E333-E341.
- Foegeding, E.A. and Davis, J.P. (2011) Food protein functionality: A comprehensive approach. *Food Hydrocoll*, **25**(8): 1853–64.
- Fox, P.F. and McSweeney, P.L. (1998) Heat-induced changes in milk. *Dairy Chemistry and Biochemistry*. Kluwer Academic/Plenum Publishers, New York, pp. 347–378.
- Fraser, D. (1951) Bursting bacteria by release of gas pressure. *Nature*, **167**(4236): 33–34.
- Fromm, H.I. and Boor, K.J. (2004) Characterization of pasteurized fluid milk shelf-life attributes. *J Food Sci*, **69**(8): M207-M214.
- Garcia-Gonzalez, L., Geeraerd, A.H., Spilimbergo, S. *et al.* (2007) High pressure carbon dioxide inactivation of microorganisms in foods: The past, the present and the future. *Int J Food Microbiol*, **117**(1): 1–28.
- Garcia-Gonzalez, L., Geeraerd, A.H., Elst, K. *et al.* (2009) Influence of type of microorganism, food ingredients and food properties on high-pressure carbon dioxide inactivation of microorganisms. *Int J Food Microbiol*, **129**(3): 253–263.
- Gill, C.O. and Tan, K.H. (1979) Effect of carbon dioxide on growth of *Pseudomonas fluorescens*. *Appl Environ Microbiol*, **38**(2): 237–240.
- Giulitti, S., Cinquemani, C. and Spilimbergo, S. (2011) High pressure gases: Role of dynamic intracellular pH in pasteurization. *Biotech Bioeng*, **108**(5): 1211–1214.
- Glass, K.A., Kaufman, K.M., Smith, A.L. *et al.* (1999) Toxin production by *clostridium botulinum* in pasteurized milk treated with carbon dioxide. *J Food Protect*, **62**(8): 872–876.
- Gueimonde, M., Alonso, L., Delgado, T. *et al.* (2003) Quality of plain yoghurt made from refrigerated and co₂-treated milk. *Food Res Int*, **36**(1): 43–48.
- Gueimonde, M. and de los Reyes-Gavilan, C.G. (2004) Reduction of incubation time in carbonated streptococcus thermophilus/lactobacillus acidophilus fermented milks as affected by the growth and acidification capacity of the starter strains. *Milchwissenschaft – Milk Sci Int*, **59**(5–6): 280–283.
- Guillaume, C., Gastaldi, E., Cuq, J.-L. and Marchesseau, S. (2004a) Effect of pH on rennet clotting properties of CO₂-acidified skim milk. *Int Dairy J*, **14**(5): 437–443.

- Guillaume, C., Jiménez, L., Cuq, J.L. and Marchesseau, S. (2004b) An original pH-reversible treatment of milk to improve rennet gelation. *Int Dairy J*, **14**(4): 305–311.
- Gunes, G., Blum, L.K. and Hotchkiss, J.H. (2005) Inactivation of yeasts in grape juice using a continuous dense phase carbon dioxide processing system. *J Sci Food Agric*, **85**(14): 2362–2368.
- Haas, G.J., Prescott, H.E., Dudley, E. *et al.* (1989) Inactivation of microorganisms by carbon dioxide under pressure. *J Food Saf*, **9**(4): 253–265.
- Hagemeyer, R. and Hotchkiss, J.H. (2011) Extended shelf life and bulk transport of perishable organic liquids with low pressure carbon dioxide. US Patent 7892590, Cornell Research Foundation, Inc. (Ithaca, NY, US).
- Hantsis-Zacharov, E. and Halpern, M. (2007) Culturable psychrotrophic bacterial communities in raw milk and their proteolytic and lipolytic traits. *Appl Environ Microbiol*, **73**(22): 7162–7168.
- Hendricks, M.T. and Hotchkiss, J.H. (1997) Effect of carbon dioxide on the growth of *Pseudomonas fluorescens* and *Listeria monocytogenes* in aerobic atmospheres. *J Food Protect*, **60**(12): 1548–1552.
- Henzler, G.W. and Paradis, A.J. (1997) Method for preparing dairy products having increased shelf-life. Patent EP 0812544 A2 (Praxair Technology, Inc).
- Heyndrickx, M., Marchand, S., Jonghe, V.d. *et al.* (2010) Understanding and preventing consumer milk microbial spoilage and chemical deterioration. In: *Improving the Safety and Quality of Milk. Volume 2: Improving Quality in Milk Products* (ed. M. Griffiths). Woodhead Publishing Series in Food Science, Technology and Nutrition. CRC Press, pp. 97–135.
- Hoffman, W. (1906) Ueber den einfluss hohen hohlensauredrucks auf bakterien im wasser und in der milch. *Arch Fur Hygiene*, **57**: 379–383.
- Hofland, G.W., van Es, M., van der Wielen, L.A.M. and Witkamp, G.J. (1999) Isoelectric precipitation of casein using high-pressure CO₂. *Ind Eng Chem Res*, **38**(12): 4919–4927.
- Hofland, G.W., Berkhoff, M., Witkamp, G.J. and Van der Wielen, L.A.M. (2003) Dynamics of precipitation of casein with carbon dioxide. *Int Dairy J*, **13**(8): 685–697.
- Hong, S.I. and Pyun, Y.R. (1999) Inactivation kinetics of *Lactobacillus plantarum* by high pressure carbon dioxide. *J Food Sci*, **64**(4): 728–733.
- Hong, S.I. and Pyun, Y.R. (2001) Membrane damage and enzyme inactivation of *Lactobacillus plantarum* by high pressure CO₂ treatment. *Int. J. Microbiol*, **63**: 19–28.
- Hongmei, L., Zhong, K., Liao, X. and Hu, X. (2014) Inactivation of microorganisms naturally present in raw bovine milk by high-pressure carbon dioxide. *Int J Food Sci Tech*, **49**(3): 696–702.
- Hoshino, T., Nakamura, K. and Suzuki, Y. (1993) Adsorption of carbon dioxide to polysaccharides in the supercritical region. *Biosci Biotech Biochem*, **57**(10): 1670–1673.
- Hotchkiss, J.H., Chen, J.H. and Lawless, H.T. (1999) Combined effects of carbon dioxide addition and barrier films on microbial and sensory changes in pasteurized milk. *J Dairy Sci*, **82**(4): 690–695.
- Hotchkiss, J. and Lee, E. (1996) Extending shelf-life of dairy products with dissolved carbon dioxide. *Eur Dairy Mag*, **8**(3): 16–18.
- Hotchkiss, J.H. and Loss, C.R. (2006) Carbon dioxide as an aid in pasteurization. US Patent 7041327, Cornell Research Foundation, Inc. (Ithaca, NY)
- Hotchkiss, J.H., Werner, B.G. and Lee, E.Y.C. (2006) Addition of carbon dioxide to dairy products to improve quality: A comprehensive review. *Compr Rev Food Sci Food Saf*, **5**(4): 158–168.

- Huang, H., Zhang, Y., Liao, H. *et al.* (2009) Inactivation of *staphylococcus aureus* exposed to dense-phase carbon dioxide in a batch system. *J Food Proc Eng*, **32**(1): 17–34.
- Hutkins, R.W. and Nannen, N.L. (1993) pH homeostasis in lactic-acid bacteria. *J Dairy Sci*, **76**(8): 2354–2365.
- Ishikawa, H., Shimoda, H., Shiratsuchi, H. and Osajima, Y. (1995) Sterilization of microorganisms by the supercritical carbon-dioxide micro-bubble method. *Biosci Biotech Biochem*, **59**(10): 1949–1950.
- Ivy, R.A., Ranieri, M.L., Martin, N.H. *et al.* (2012) Identification and characterization of psychrotolerant sporeformers associated with fluid milk production and processing. *Appl Environ Microbiol*, **78**(6): 1853–1864.
- Jay, J.M. (2000) *Modern Food Microbiology*. Aspen Publishing, Gaithersburg, MD.
- Jones, R.P. and Greenfield, P.F. (1982) Effect of carbon-dioxide on yeast growth and fermentation. *Enzyme Microbial Tech*, **4**(4): 210–222.
- Jordan, P.J., Lay, K., Ngan, N. and Rodley, G.F. (1987) Casein precipitation using high pressure carbon dioxide. *J Dairy Sci Tech NZ*, **22**: 247–256.
- Juric, M., Bertelsen, G., Mortensen, G. and Petersen, M.A. (2003) Light-induced colour and aroma changes in sliced, modified atmosphere packaged semi-hard cheeses. *Int Dairy J*, **13**(2): 239–49.
- Kamihira, M., Taniguchi, M. and Kobayashi, T. (1987) Sterilization of microorganisms with supercritical carbon-dioxide. *Agric Biol Chem*, **51**(2): 407–412.
- Kaneno, M., Isogai, T., Tanaka, N. *et al.* (2011) *Method for separating dairy ingredient*, Snow Brand Milk Products Co Ltd.
- Karagul-Yuceer, Y., Coggins, P.C., Wilson, J.C. and White, C.H. (1999) Carbonated yogurt: Sensory properties and consumer acceptance. *J Dairy Sci*, **82**: 1394–1398.
- Karagul-Yuceer, Y., Wilson, J.C. and White, C.H. (2001) Formulations and processing of yogurt affect the microbial quality of carbonated yogurt. *J Dairy Sci*, **84**: 543–550.
- Kim, S.R., Park, H.J., Yim, D.S. *et al.* (2008). Analysis of survival rates and cellular fatty acid profiles of *Listeria monocytogenes* treated with supercritical carbon dioxide under the influence of cosolvents. *J Microbiol. Methods*, **75**(1): 47–54.
- Kincal, D., Hill, W.S., Balaban, M. *et al.* (2006) A continuous high-pressure carbon dioxide system for cloud and quality retention in orange juice. *J Food Sci*, **71**(6): C338–C44.
- Kobayashi, F. (2007) The durability of the bactericidal effect of supercritical CO₂ bubbling of *E. Coli* bacteria. *Bulletin of the School of Agriculture Meiji University (Japan)*, **57**(1): 13–17.
- Kollmann, C.J.W., Hofland, G.W., Van Der Wielen, L.A.M. and Witkamp, G.-J. (2003) Method for the sequential precipitation of casein and calcium phosphate from a milk source. US Patent No. 6,558,717.
- Kozempel, M. and Tomasula, P.M. (2005) Development of a semi-continuous process for co2-precipitated-casein films. *Abstr Pap Am Chem Soc*, **229**: U302.
- Lavoie, K., Touchette, M., St-Gelais, D. and Labrie, S. (2012) Characterization of the fungal microflora in raw milk and specialty cheeses of the province of Quebec. *Dairy Sci Tech*, **92**(5): 455–468.
- Lee, E.Y.C. (1996). Carbon dioxide gas analysis and application in the determination of the shelf-life of modified atmosphere packaged dairy products. MS thesis, Cornell University, USA.
- Lee, E.Y.C. and Hotchkiss, J.H. (1997) Microbial changes in cottage cheese packaged in 2.27 kg flexible film pouches and stored at 4 and 7°C (abstr). *J Dairy Sci*, **80** (Suppl 1): 129.

- Leistner, I. (2000) Basic aspects of food preservation by hurdle technology. *Int J Food Microbiol*, **55**: 181–186.
- Lin, H.M., Yang, Z.Y. and Chen, L.F. (1992) Inactivation of *saccharomyces-cerevisiae* by supercritical and subcritical carbon-dioxide. *Biotech Prog*, **8**(5): 458–461.
- Lin, H.M., Yang, Z.Y. and Chen, L.F. (1993) Inactivation of *leuconostoc-dextranicum* with carbon-dioxide under pressure. *Chem Eng J Biochem Eng J*, **52**(1): B29-B34.
- Lin, H.M., Cao, N.J. and Chen, L.F. (1994) Antimicrobial effect of pressurized carbon-dioxide on *listeria monocytogenes*. *J Food Sci*, **59**(3): 657–659.
- Lindbäck, T. and Granum, P.E. (2013) *Bacillus cereus*. *Guide to Foodborne Pathogens*, 2nd edn. John Wiley & Sons Ltd, pp. 75–81.
- Llonillo-Lamsen, M.R. and Zhong, Q. (2011) Impacts of supercritical extraction on gc/ms profiles of volatiles in whey protein isolate sampled by solid-phase microextraction. *J Food Proc Preserv*, **35**(6): 869–819283.
- Loss, C.R. and Hotchkiss, J.H. (2002) Effect of dissolved carbon dioxide on thermal inactivation of microorganisms in milk. *J Food Protect*, **65**(12): 1924–9.
- Lubary, M., Hofland, G.W. and ter Horst, J.H. (2010) Synthesis and isolation of added-value milk fat derivatives using lipase-catalyzed reactions and supercritical carbon dioxide. *Lipid Tech*, **22**(3): 54–57.
- Luu-Thi, H., Grauwet, T., Vervoort, L. *et al.* (2014) Kinetic study of *Bacillus cereus* spore inactivation by high pressure high temperature treatment. *Innov Food Sci Emerg Tech*, **19**: 45–52.
- Ma, Y. and Barbano, D.M. (2003) Milk pH as a function of CO₂ concentration, temperature, and pressure in a heat exchanger. *J Dairy Sci*, **86**(12): 3822–3830.
- Ma, Y., Barbano, D.M., Hotchkiss, J.H. *et al.* (2001) Impact of CO₂ addition to milk on selected analytical testing methods. *J Dairy Sci*, **84**(9): 1959–1968.
- Ma, Y., Barbano, D.M. and Santos, M. (2003) Effect of CO₂ addition to raw milk on proteolysis and lipolysis at 4°C. *J Dairy Sci*, **86**(5): 1616–1631.
- Martin, J.D., Werner, B.G. and Hotchkiss, J.H. (2003) Effects of carbon dioxide on bacterial growth parameters in milk as measured by conductivity. *J Dairy Sci*, **86**(6): 1932–1940.
- Martin, N.H., Carey, N.R., Murphy, S.C. *et al.* (2012a) A decade of improvement: New York state fluid milk quality. *J Dairy Sci*, **95**(12): 7384–7390.
- Martin, N.H., Ranieri, M.L., Wiedmann, M. and Boor, K.J. (2012b) Reduction of pasteurization temperature leads to lower bacterial outgrowth in pasteurized fluid milk during refrigerated storage: A case study. *J Dairy Sci*, **95**(1): 471–475.
- Moir, C.J., Eyles, M.J. and Davey, J.A. (1993) Inhibition of *Pseudomonas* in cottage cheese by packaging in atmospheres containing carbon dioxide. *Food Microbiol*, **10**: 345–351.
- Montilla, A., Calvo, M.M. and Olano, A. (1995) Manufacture of cheese made from CO₂-treated milk. *Zeitschrift fuer Lebensmittel-Untersuchung und Forschung*, **200**(4): 289–292.
- Moore, J.M., Smith, A.C. and Gosslee, D.G. (1961) Effect of carbon dioxide upon freezing point of vacuum treated milk. *J Milk Food Tech*, **24**: 176–180.
- Muir, D.D. (1996) The shelf-life of dairy products: 1. Factors influencing raw milk and fresh products. *J Soc Dairy Tech*, **49**(1): 24–32.
- Munsch-Alatossava, P. and Alatossava, T. (2006) Phenotypic characterization of raw milk-associated psychrotrophic bacteria. *Microbiol Res*, **161**: 334–346.
- Murphy, S.C. (2009) Shelf life of fluid milk products – Microbial spoilage – The Evaluation of Shelf-Life. Dairy Foods Science Notes, Cornell University. (<http://foodsafety.foodscience.cornell.edu/sites/foodsafety.foodscience.cornell.edu/files/shared/>)

- documents/CU-DFScience-Notes-Bacteria-Milk-Shelf-Life-Evaluaton-06-09.pdf; last accessed 16 January 2015).
- Nakamura, K., Hoshino, T. and Ariyama, H. (1991) Adsorption of carbon dioxide on proteins in the supercritical region. *Agric Biol Chem*, **55**(9): 2341–2347.
- Nakamura, K., Enomoto, A., Fukushima, H. *et al.* (1994) Disruption of microbial-cells by the flash discharge of high-pressure carbon-dioxide. *Biosci Biotech Biochem*, **58**(7): 1297–1301.
- Nelson, B. and Barbano, D. (2005). Moisture retention and salt uptake in cheddar curds made from milk pre-acidified with carbon dioxide: A possible solution to the salt whey problem. *2005 ADSA-ASAS Joint Annual Meeting*, Cincinnati, OH.
- Nelson, B.K., Lynch, J.M. and Barbano, D.M. (2004a) Impact of milk preacidification with CO₂ on the aging and proteolysis of cheddar cheese. *J Dairy Sci*, **87**(11): 3590–3600.
- Nelson, B.K., Lynch, J.M. and Barbano, D.M. (2004b) Impact of milk preacidification with cCO₂ on cheddar cheese composition and yield. *J Dairy Sci*, **87**(11): 3581–3589.
- Noll, C.I. and Supplee, G.C. (1941) Factors affecting the gas content of milk. *J Dairy Sci*, **24**(22): 993–1013.
- Noriega, L., Gueimonde, M., Alonso, L. and de los Reyes-Gavilán, C.G. (2003) Inhibition of *Bacillus cereus* growth in carbonated fermented bifidus milk. *Food Microbiol*, **20**(5): 519–526.
- Novak, J.S., Call, J., Tomasula, P. and Luchansky, J.B. (2005) An assessment of pasteurization treatment of water, media, and milk with respect to *Bacillus* spores. *J Food Protect*, **68**(4): 751–757.
- Olano, A., Calvo, M.M., Troyano, E. and Amigo, L. (1992) Changes in the fractions of carbohydrates and whey proteins during heat-treatment of milk acidified with carbon-dioxide. *J Dairy Res*, **59**(1): 95–99.
- Oliver, S.P., Boor, K.J., Murphy, S.C. and Murinda, S.E. (2009) Food safety hazards associated with consumption of raw milk. *Foodborne Pathog Dis*, **6**(7): 793–806.
- Parris, N., Dickey, L.C., Tomasula, P.M. *et al.* (2001) Films and coatings from commodity agroproteins. *ACS Symposium Series*, **786**: 118–131.
- Parton, T., Elvassore, N., Bertucco, A. and Bertoloni, G. (2007) High pressure co2 inactivation of food: A multi-batch reactor system for inactivation kinetic determination. *J Supercrit Fluids*, **40**(3).
- Perrut, M. (2012) Sterilization and virus inactivation by supercritical fluids (a review). *J Supercrit Fluids*, **66**(0): 359–371.
- Prado, G.H.C., Khan, M., Saldana, M.D.A. and Temelli, F. (2012) Enzymatic hydrolysis of conjugated linoleic acid-enriched anhydrous milk fat in supercritical carbon dioxide. *J Supercrit Fluids*, **66**: 198–206.
- Prucha, M.J., Brannon, J.M. and Ruehe, H.A. (1925) Carbonation of butter. *J Dairy Sci*, **8**: 318–321.
- Rajagopal, M., Werner, B.G. and Hotchkiss, J.H. (2005) Low pressure CO₂ storage of raw milk: Microbiological effects. *J Dairy Sci*, **88**(9): 3130–3138.
- Ranieri, M.L., Huck, J.R., Sonnen, M. *et al.* (2009) High temperature, short time pasteurization temperatures inversely affect bacterial numbers during refrigerated storage of pasteurized fluid milk. *J Dairy Sci*, **92**(10): 4823–4832.
- Raouche, S., Dobenesque, M., Bot, A. *et al.* (2007) Stability of casein micelle subjected to reversible CO₂ acidification: Impact of holding time and chilled storage. *Int Dairy J*, **17**(8): 873–880.

- Ravindra, M.R., Rao, K.J., Nath, B.S. and Ram, C. (2014a) Extended shelf life flavoured dairy drink using dissolved carbon dioxide. *J Food Sci Tech*, **51**(1): 130–135.
- Ravindra, M.R., Rao, K.J., Nath, B.S. and Ram, C. (2014b) Carbonated fermented dairy drink – effect on quality and shelf life. *J Food Sci Tech*, **51**(11): 3397–3403.
- Rowe, M. (1989) Carbon dioxide to prolong the safe storage of raw milk. *Milk Industry, UK*, **91**(7): 17–19.
- Ruas-Madiedo, P., Bada-Gancedo, J.C., Fernandez-Garcia, E. *et al.* (1996a) Preservation of the microbiological and biochemical quality of raw milk by carbon dioxide addition: A pilot-scale study. *J Food Protect*, **59**(5): 502–508.
- Ruas-Madiedo, P., Bada-Gancedo, J.C., Matilla-Villoslada, M. and De Los Reyes-Gavilán, C.G. (1996b) Pilot plant application of carbon dioxide injection to increase the storage life of refrigerated raw milk. *Revista Española de Lechería*, (**74**): 35–41.
- Ruas-Madiedo, P., Bada-Gancedo, J.C., Alonso, L. and de los Reyes-Gavilan, C.G. (1998a) Afuega'l pitu cheese quality: Carbon dioxide addition to refrigerated milk in acid-coagulated cheesemaking. *Int Dairy J*, **8**(12): 951–958.
- Ruas-Madiedo, P., Bascarán, V., Braña, A.F. *et al.* (1998b) Influence of carbon dioxide addition to raw milk on microbial levels and some fat-soluble vitamin contents of raw and pasteurized milk. *J Agric Food Chem*, **46**(4): 1552–1555.
- Ruas-Madiedo, P., de los Reyes-Gavilan, C.G., Olano, A. and Villamiel, M. (2000) Influence of refrigeration and carbon dioxide addition to raw milk on microbial levels, free monosaccharides and myo-inositol content of raw and pasteurized milk. *Eur. Food Res. Tech*, **212**(1): 44–47.
- Ruas-Madiedo, P., Alonso, L., Delgado, T. *et al.* (2002) Manufacture of spanish hard cheeses from co₂-treated milk. *Food Res. Int*, **35**(7): 681–90.
- Sierra, I., Prodanov, M., Calvo, M. *et al.* (1996) Vitamin stability and growth of psychrotrophic bacteria in refrigerated raw milk acidified with carbon dioxide. *J Food Protect*, **59**(12): 1305–1310.
- Singh, P., Wani, A.A., Karim, A.A. and Langowski, H.C. (2012) The use of carbon dioxide in the processing and packaging of milk and dairy products: A review. *Int J Dairy Tech*, **65**(2): 161–77.
- Sirisee, U., Hsieh, F. and Huff, H.E. (1998) Microbial safety of supercritical carbon dioxide processes. *J Food Proc Preserv*, **22**(5): 387–403.
- Smith, A.C. (1964) The carbon dioxide content of milk during handling, processing and storage and its effect upon the freezing point. *J. Milk Food Technol*, **27**(2): 38–41.
- Spano, V., Salis, A., Mele, S. *et al.* (2004) Fractionation of sheep milk fat via supercritical carbon dioxide. *Food Sci Tech Int*, **10**(6): 421–425.
- Spilimbergo, S. and Bertucco, A. (2003) Non-thermal bacterial inactivation with dense CO₂. *Biotech Bioeng*, **84**(6): 627–638.
- Spilimbergo, S. and Mantoan, D. (2005) Stochastic modeling of *S. Cerevisiae* inactivation by supercritical CO₂. *Biotechnol Prog*, **21**(5): 1461–1465.
- Spilimbergo, S., Elvassore, N. and Bertucco, A. (2002) Microbial inactivation by high-pressure. *J Supercrit Fluids*, **22**(1): 55–63.
- Spilimbergo, S., Dehghani, F., Bertucco, A. and Foster, N.R. (2003a) Inactivation of bacteria and spores by pulse electric field and high pressure CO₂ at low temperature. *Biotech Bioeng*, **82**(1): 118–125.
- Spilimbergo, S., Elvassore, N. and Bertucco, A. (2003b) Inactivation of microorganisms by supercritical CO₂ in a semi-continuous process. *Ital J Food Sci*, **15**(1): 115–124.

- St-Gelais, D., Champagne, C.P. and Belanger, G. (1997) Production of cheddar cheese using milk acidified with carbon dioxide. *Milchwissenschaft – Milk Sci Int*, **52**(11): 614–618.
- Strange, E.D., Konstance, R.P., Tomasula, P.M. *et al.* (1998) Functionality of casein precipitated by carbon dioxide. *J Dairy Sci*, **81**(6): 1517–1524.
- Taylor, D.P. and Ogden, L.V. (2002) Carbonation of viscous fluids: Carbon dioxide holding capacity and rate to saturation of simulated yogurt. *J Food Sci*, **67**: 1032–1035.
- Ternstrom, A., Lindberg, A.M. and Molin, G. (1993) Classification of the spoilage flora of raw and pasteurized bovine-milk, with special reference to *Pseudomonas* and *Bacillus*. *J Appl Bacteriol*, **75**: 25–34.
- Tomasula, P.M. (1995) Process for the continuous removal of products from high-pressure systems. US Patent No 5,432,265.
- Tomasula, P.M. (2002) Edible, water-solubility resistant casein masses US Patent No 6,379,726.
- Tomasula, P.M. (2003) Supercritical fluid extraction of foods. In: *Encyclopedia of Agricultural, Food, and Biological Engineering* (ed. D.R. Heldman). Dekker, New York, pp. 964–967.
- Tomasula, P.M. and Boswell, R.T. (1999) Measurement of the solubility of carbon dioxide in milk at high pressures. *J Supercrit Fluid*, **16**: 21–26.
- Tomasula, P.M. and Parris, N. (1999) Whey protein fractionation using high pressure or supercritical carbon dioxide. US Patent No 5,925,737.
- Tomasula, P.M., Craig, J.C., Jr., Boswell, R.T. *et al.* (1995) Preparation of casein using carbon dioxide. *J Dairy Sci*, **78**(3): 506–514.
- Tomasula, P.M., Craig, J.C., Jr. and Boswell, R.T. (1997) A continuous process for casein production using high-pressure carbon dioxide. *J Food Eng*, **33**: 405–419.
- Tomasula, P.M., Craig, J.C., Jr. and McAloon, A.J. (1998a) Economic analysis of a continuous casein process using carbon dioxide as precipitant. *J Dairy Sci*, **81**(12): 3331–3342.
- Tomasula, P.M., Parris, N., Boswell, R.T. and Moten, R.O. (1998b) Preparation of enriched fractions of α -lactalbumin and β -lactoglobulin from cheese whey using carbon dioxide. *J Food Proc Preserv*, **22**: 463–476.
- Tomasula, P.M., Parris, N., Yee, W. and Coffin, D. (1998c) Properties of films made from CO₂-precipitated casein. *J Agric Food Chem*, **46**(11): 4470–4474.
- Tomasula, P.M., Boswell, R.T. and Dupre, N.C. (1999) Buffer properties of milk treated with high pressure carbon dioxide. *Milchwissenschaft – Milk Sci Int*, **54**: 667–670.
- Tomasula, P.M., Yee, W.C. and Parris, N. (2003) Oxygen permeability of films made from CO₂-precipitated casein and modified casein. *J Agric Food Chem*, **51**(3): 634–639.
- Torkar, K.G. and Vengušt, A. (2008) The presence of yeasts, moulds and aflatoxin M₁ in raw milk and cheese in Slovenia. *Food Control*, **19**(6): 570–577.
- Van Hekken, D.L., Rajkowski, K.T., Tomasula, P.M. *et al.* (2000) Effect of carbon dioxide under high pressure on the survival of cheese starter cultures. *J Food Protect*, **63**(6): 758–762.
- Vianna, P.C.B., Walter, E.H.M., Dias, M.E.F. *et al.* (2012) Effect of addition of CO₂ to raw milk on quality of UHT-treated milk. *J Dairy Sci*, **95**(8): 4256–4262.
- Vinderola, C.G., Gueimonde, M., Delgado, T. *et al.* (2000) Characteristics of carbonated fermented milk and survival of probiotic bacteria. *Int Dairy J*, **10**(3): 213–220.
- Walsh, H., Cheng, J.J. and Guo, M.R. (2014) Effects of carbonation on probiotic survivability, physicochemical, and sensory properties of milk-based symbiotic beverages. *J Food Sci*, **79**(4): M604-M13.

- Wang, L. and Li, X. (2007) Impact of carbon dioxide addition to raw milk on physical property and stability. *China Dairy Ind*, **35**(4): 26–29.
- Wei, C.I., Balaban, M.O., Fernando, S.Y. and Peplow, A.J. (1991) Bacterial effect of high-pressure CO₂ treatment on foods spiked with listeria or salmonella. *J Food Protect*, **54**(3): 189–193.
- Werner, B.G. and Hotchkiss, J.H. (2002) Effect of carbon dioxide on the growth of *Bacillus cereus* spores in milk during storage. *J Dairy Sci*, **85**(1): 15–18.
- Werner, B.G. and Hotchkiss, J.H. (2006) Continuous flow nonthermal CO₂ processing: The lethal effects of subcritical and supercritical CO₂ on total microbial populations and bacterial spores in raw milk. *J Dairy Sci*, **89**(3): 872–881.
- Wright, A.O., Ogden, L.V. and Eggett, D.L. (2003) Determination of carbonation threshold in yogurt. *J Food Sci*, **68**(1): 378–881.
- Xiong, R., Xie, G., Edmondson, A.E. and Sheard, M.A. (1999) A mathematical model for bacterial inactivation. *Int J Food Microbiol*, **46**: 45–55.
- Yee, J.L., Khalil, H. and Jiménez-Flores, R. (2007) Flavor partition and fat reduction in cheese by supercritical fluid extraction: Processing variables. *Lait*, **87**(4–5): 269–285.
- Yver, A.L., Bonnaillie, L.M., Yee, W. *et al.* (2011) Fractionation of whey protein isolate with supercritical carbon dioxide – process modeling and cost estimation. *Int J Molec Sci*, **13**(1): 240–259.

9

Non-Thermal Pasteurization of Milk Using CHIEF Technology

Shaobo Deng¹, Paul Chen¹, Yun Li¹, Xiaochen Ma¹, Yanling Cheng¹, Xiangyang Lin¹, Lloyd Metzger², and Roger Ruan¹

¹*Department of Bioproducts and Biosystems Engineering and Department of Food Science and Nutrition, University of Minnesota, USA*

²*Dairy Foods Research Center and Department of Dairy Science, South Dakota State University, USA*

9.1 Introduction

The concentrated high intensity electric field (CHIEF) is a new process for nonthermal pasteurization of liquid foods developed by researchers at the University of Minnesota (Ruan *et al.*, 2008). A CHIEF system uses a unique treatment chamber (orifice) and electrode configuration where a high intensity electric field is concentrated within the orifice through which liquid flows and is pasteurized. The structure of a CHIEF system bears characteristics similar to those of dielectric barrier nonthermal plasma (NTP) reactors, which often consist of two electrodes separated by one or two layers of dielectric materials. However, the mechanisms of microbial inactivation by CHIEF resemble more closely those of pulsed electric fields technology (Chapter 5) than those of NTP. In comparison with PEF technology, CHIEF has some unique characteristics: (i) it is powered by industrial frequency AC power instead of high frequency pulsed direct current (DC) power, thus its capital costs are significantly lower; (ii) it uses a nonmetal (dielectric) barrier to avoid direct contact between the electrodes and the liquid, practically eliminating contamination from the oxidation, corrosion and erosion of metal electrodes, and avoiding the need to change electrodes periodically.

A 5 log₁₀ reduction of *Escherichia coli* O157:H7 (*E. coli* O157) and 7 log₁₀ reduction of lactic acid bacteria inoculated in orange juice and a 3–5 log₁₀ reduction of *E. coli* O157, *Salmonella* and *Listeria monocytogenes* inoculated in milk have been

demonstrated (unpublished data). No significant physical and chemical changes in the products were observed. Experimental data generated so far are limited, and a solid understanding of the processes is lacking. The purpose of this chapter is to provide interested researchers useful information on the basic principles of the CHIEF process and physical structure, and its effects on microorganisms and food components, so that more research and development efforts can be undertaken to understand and improve this new nonthermal technology.

9.2 Principles

9.2.1 Biological Effects

Mechanistic studies on microbial inactivation by CHIEF have not been conducted. As mentioned earlier, it is assumed that the CHIEF process kills microbes in a way similar to the high intensity pulsed electric fields (PEF) process. PEF involves the application of short pulses (1–10 μ s) of high voltage (typically 20–80 kV/cm) to food materials located between two metal (usually stainless steel) electrodes which form the so-called treatment chamber (Qin *et al.*, 1996; Vega-Mercado *et al.*, 1997), while in the CHIEF process liquid flows through a high intensity electric field concentrated within a small orifice. Studies of exposure of microorganisms to electric fields have indicated that an electric field can cause changes to cell membranes (Pothakamury *et al.*, 1997; Barbosa-Cánovas *et al.*, 1999). When a voltage is applied to a cell, a sufficiently high transmembrane potential is induced across the cell membrane, causing the membrane to rupture (direct mechanical damage, the electric breakdown theory), or destabilizing the lipid and protein layers of cell membranes, resulting in pores (electroporation theory). The damaged cell membrane loses its selective semi-permeability, which allows water to enter the cell, and results in excessive cell volume swelling and, ultimately, leads to cell rupture and inactivation of the organism. Some studies have provided microscopic evidence to support this theory (Harrison *et al.*, 1997; Calderón-Miranda *et al.*, 1999). Recent studies have shown increased membrane permeability after PEF treatment (Aronsson *et al.*, 2005; García *et al.*, 2007). Different levels of microbial inactivation were achieved with PEF treatment depending on the type of samples, type of microbe, the field strength and the number of pulses applied during the process (Martin *et al.*, 1997; Pothakamury *et al.*, 1997; Bai-Lin *et al.*, 1998; Qin *et al.*, 1998). The inactivation of enzymes by PEF is limited and the effectiveness has been shown to vary with the electric field intensity, the number of pulses applied during the process and the intrinsic characteristics of the enzyme (Bendicho *et al.*, 2003; Kambiz *et al.*, 2008). To understand and improve the CHIEF process, further research is necessary to study the biological mechanisms of microbial and enzymatic inactivation by CHIEF.

9.2.2 Physical Principles

The basic principle of generation of CHIEF is capacitance coupling. Figures 9.1 and 9.2 represent the configuration of a CHIEF treatment chamber (orifice) and its equivalent circuit model. A nonconducting block divides the liquid layer into two parts (bulk liquid, BL) with a narrow liquid channel (LC) between them. The dielectric barrier

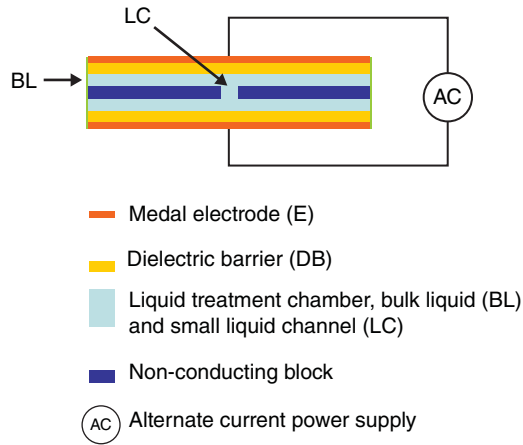

Figure 9.1 Schematic diagram of a CHIEF treatment chamber characterized by a dielectric barrier (DB) reactor with a narrow liquid channel.

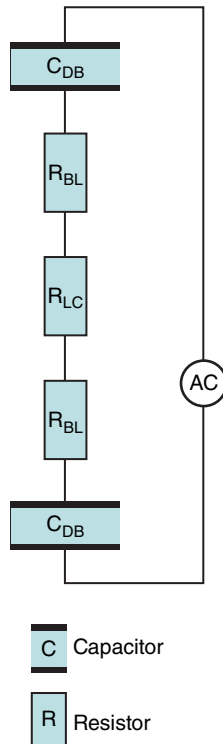

Figure 9.2 Analogous electrical circuit for the DB reactor shown in Figure 9.1.

sandwiched between the medal electrode and water electrode forms a capacitor (C_{DB}) and the bulk liquid and liquid channel are treated as two different resistors, namely R_{BL} and R_{LC} , respectively. In order to concentrate the electric field on the narrow channel, the energy consumption by the bulk liquid must be significantly reduced. Therefore, the structure must be designed so that R_{BL} is much smaller than R_{LC} or negligible, and hence $(2R_{BL} + R_{LC}) \cong R_{LC}$. The electric field, E_{LC} , across the length of the liquid channel, d_{LC} , of the R_{LC} when a voltage of U_a is applied is expressed as:

$$E_{LC} = \frac{U_{LC}}{d_{LC}} \quad (9.1)$$

where the voltage of the liquid channel:

$$U_{LC} = I \cdot R_{LC} = \frac{U_a}{Z} \cdot R_{LC} \quad (9.2)$$

The total impedance of circuit Z can be found using the equation:

$$Z = \sqrt{R_{LC}^2 + X_C^2} \quad (9.3)$$

Equation 9.2 is therefore transformed to:

$$U_{LC} = \frac{U_a}{\sqrt{1 + \left(\frac{X_C}{R_{LC}}\right)^2}} \quad (9.4)$$

where the resistance of the liquid channel is $R_{LC} = \frac{d_{LC}}{\sigma A_{LC}}$, σ is the electric conductivity and A_{LC} is the area. The reactance of the capacitors is $X_C = \frac{1}{2\pi f C}$, where f is the current frequency and C is the total capacitance of the circuit, which is calculated as: $\frac{1}{C} = \frac{2}{C_{DB}}$, or $C = \frac{1}{2} C_{DB} = \frac{1}{2} \frac{\epsilon A_{DB}}{d_{DB}}$, where ϵ is the dielectric constant, with its value generally ranging from 2 to 10 for most solid dielectric materials. A_{DB} is the area and d_{DB} is the thickness of the dielectric barrier. Taking U_{LC} from Equation 9.4 and R_{LC} and X_C described above, Equation 9.1 is therefore transformed to:

$$E_{LC} = \frac{U_a}{\sqrt{d_{LC}^2 + \left(\frac{\sigma d_{DB}}{\epsilon \pi f} \cdot \frac{A_{LC}}{A_{DB}}\right)^2}} \quad (9.5)$$

Equation 9.5 indicates that if $\frac{\sigma d_{DB}}{\epsilon \pi f} \cdot \frac{A_{LC}}{A_{DB}}$ is negligible, then $E_{LC} \propto \frac{U_a}{d_{LC}}$, and most of the applied voltage would be directed to the liquid within the narrow channel. In order to make $\frac{\sigma d_{DB}}{\epsilon \pi f} \cdot \frac{A_{LC}}{A_{DB}}$ negligible, a very thin (small thickness d_{DB}) dielectric barrier with very high dielectric constant (high ϵ), or a very low ratio of A_{LC} to A_{DB} (area of dielectric barrier which is also the area of bulk liquid, A_{BL}) could be used. The strength and generation efficiency of the high intensity electrical field may be manipulated through choosing or optimizing treatment chamber configuration and dielectric barrier material. Since the availability of high dielectric-constant material resources

may be limited, changing the area ratio $\frac{A_{LC}}{A_{DB}}$ appears to be the preferred simple way to increase the electric field.

The diameters of the nonconducting block and the orifice in the centre of the block allow manipulation of $\frac{A_{LC}}{A_{DB}}$ to achieve a high electric field across R_{LC} . A large A_{DB} or A_{BL} is also important to support the assumption that R_{BL} is much smaller than R_{LC} or negligible. Figure 9.3 shows the electric field strength as a function of $\frac{A_{LC}}{A_{DB}}$ under peak voltage (replacing the denominator with $U_a \sqrt{2}$ in Equation 9.5) for water and milk. The curves show that $\frac{A_{LC}}{A_{DB}}$ of 5×10^{-3} and 5×10^{-4} is sufficient to achieve electric field strength, E_{LC} , of higher than or equal to 25 kV/cm for milk and water, respectively when the applied voltage (RMS voltage) is 4 kV, and d_{LC} and d_{DB} are both 0.1cm.

9.3 Equipment and Process Flow

A simple experimental CHIEF device consists of a treatment chamber, a power supply with control, electrical wires and liquid tubing (Figure 9.4). Figure 9.4a shows the entire set-up and Figure 9.4b is a close-up of the treatment chamber, where the orifice is located in the middle of the glass enclosure; copper foils as electrodes are also visible. This device was used to conduct the proof of concept experiments. Figure 9.5 shows a small mobile pilot scale CHIEF system consisting of four treatment chambers/reactors, which can be arranged in series or parallel. Temperature control

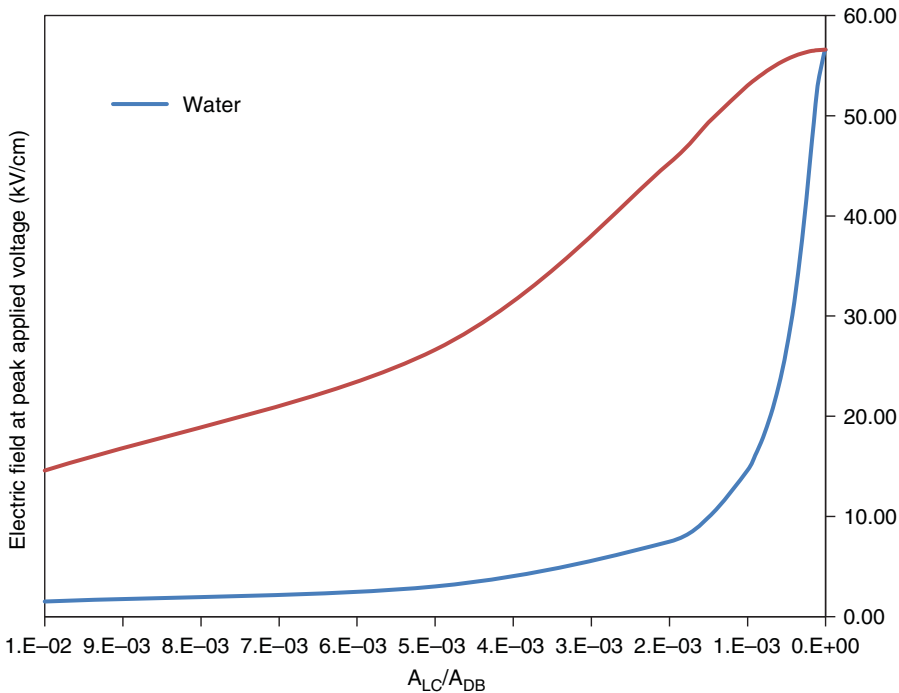

Figure 9.3 Electric field as a function of ratio of A_{LC} to A_{DB} .

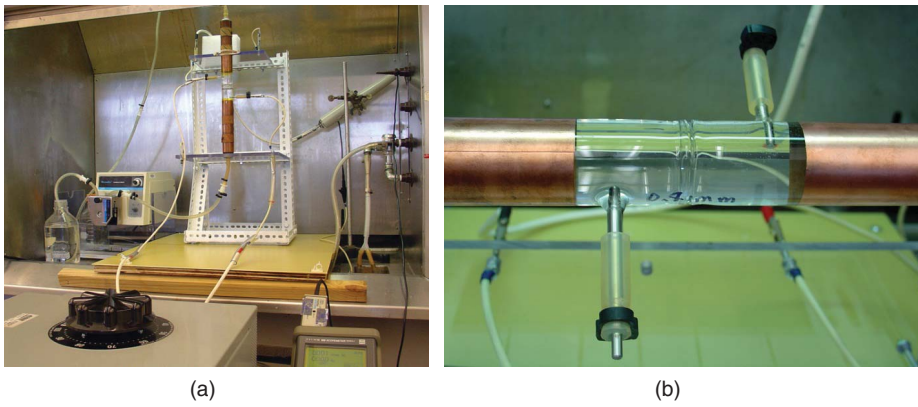

Figure 9.4 Experimental device to prove the CHIEF concept.



Figure 9.5 Small pilot scale CHIEF system with four treatment chambers/reactors (R1, R2, R3 and R4).

elements were added before and after the reactor to control the temperature of the liquid entering and leaving a reactor. A back pressure regulator was used to maintain the proper high pressure to avoid formation of bubbles in the liquid stream because localized electrical discharges may occur in the air filled bubbles, causing material breakdowns. The high pressure, which is around 1000 KPa in this system, has three purposes. Firstly, it ensures a high flow rate through the small orifice of the reactor, enough to bring the heat generated during the treatment quickly to the cooling stage. The target exit temperature is below 60°C. The higher pressure allows raising the applied voltage, U_a , and hence the electric field, E_{LC} , without causing the exit temperature to go beyond 60°C. Secondly, a high pressure can prevent electric discharge in the liquid, which would otherwise cause damage to milk and the reactor structure. Thirdly, it reduces the electrical conductivity of the liquid being treated and, thus, minimizes temperature rise. There is a challenge though in finding a dielectric material with a reasonable mechanical strength to withstand the pressure. In this small pilot scale system, the treatment chamber/reactor was modified to exclude the dielectric barriers, which gives up the benefit of using dielectric barriers to separate liquid food from the metal electrodes, but, on the other hand, renders the highest value of E_{LC} because $X_C = 0$ in Equation 9.4. This system was used to produce the experimental data presented in Sections 9.4 and 9.5.

The process flow diagram for an experimental CHIEF system is shown in Figure 9.6. Liquid is pumped from the sample tank through a series of temperature control elements and treatment chambers (reactors). The temperature of the sample is

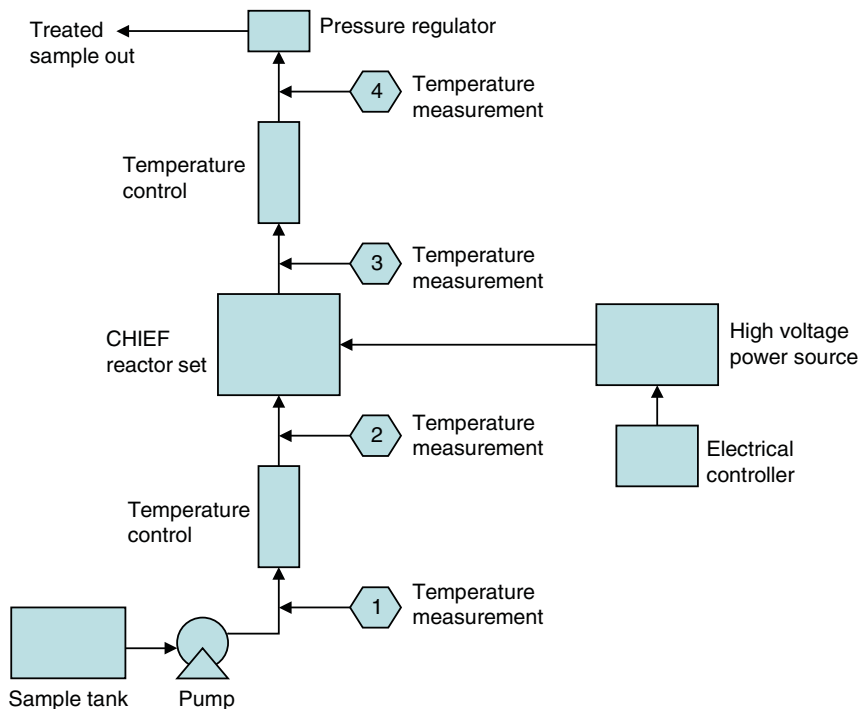

Figure 9.6 Process flow diagram for CHIEF treatment.

monitored throughout the process. The following process parameters can be adjusted during experiments:

- Electrical field strength, E_{LC} : 10–70 kV/cm
- AC power frequency: 60 Hz
- Flow rate (which determines the residence time in the reactors): 500–2000 ml/min
- Range of residence times for reactors: 10–400 μ s
- Feed temperature of milk: 4–10°C
- Number of reactors connected in series: 1–4
- Number of passes through the reactors: 1–2.

9.4 Effects of the Process on Microorganisms and Quality

9.4.1 Microorganisms

Table 9.1 shows that a greater than 3 log reduction of five different *E. coli* O157:H7 strains, inoculated into skimmed milk, was achieved with one pass treatment when the applied voltage was 35–40 kV and the exit temperature was below 60°C. The greater log reduction at higher electric field was due to the combination of increased electric field and temperature. There is a synergistic effect between the applied electric field and temperature. Although 60°C is below the usual pasteurization temperature and treatment time was much shorter than that of a pasteurization process, it may induce stress reactions, resulting in bacteria exhaustion and reduced resistance to electric field treatment (Geveke and Brunkhorst, 2004; Ukuku *et al.*, 2008). Stress reaction and bacteria exhaustion are mechanisms proposed for the hurdle technology, which applies a series of minimal processes including mild heat treatment to a food system to achieve required bacterial kills but with reduced undesirable impacts compared with conventional processes.

To examine the response of mixed bacteria inoculated into skimmed milk to CHIEF treatment, mixtures of multiple strains of targeted bacteria were tested (Table 9.2). When a mixture of five *E. coli* O157:H7 strains was tested, cell inactivation ranged from almost 2 to 3.9 log₁₀ CFU/ml after a single pass through the CHIEF apparatus

Table 9.1 Bacterial count of *E. coli* O157:H7 inoculated into skimmed milk before and after treatment with CHIEF (temperature 55–60°C, applied voltage 3.5–4 kV)

<i>E. coli</i> O157:H7 Strains	Inoculum (log ₁₀ CFU/ml)	Post-treatment count (log ₁₀ CFU/ml)	Population reduction (log ₁₀ CFU/ml)
ATCC43890	5.76	<2.00	≥3.76
ATCC43895	5.94	<2.00	≥3.94
ATCC35150	5.40	<2.00	≥3.40
86-24	7.94	4.79	3.14
Mixture of ATCC43890, 43895, 35150, 86-24 and 3081	8.05	4.16	3.88

Table 9.2 Effect of a single-pass CHIEF treatment on viable count of pathogenic bacteria inoculated into skimmed milk (temperature 55–60°C, applied voltage 3.5–4 kV)

Bacteria	Replicate trial number	Initial count (log ₁₀ CFU/ml)	Final count (log ₁₀ CFU/ml)	Reduction (log ₁₀ CFU/ml)
<i>Escherichia coli</i> O157:H7 (5-strain mixture)	EC1	8.05	4.16	3.88
	EC2	8.01	5.61	2.39
	EC3	7.95	5.99	1.96
<i>Salmonella</i> (5-strain mixture)	S-N	7.93	4.86	3.07
	S-Tn	8.16	5.04	3.11
	S-Ty1	8.19	5.38	2.81
	S-Ty2	7.93	5.14	2.79
	S-Ty3	8.09	4.90	3.18
<i>Salmonella</i> (5-strain mixture)	S1	8.10	4.78	3.32
	S2	8.02	5.40	2.62
	S3	8.14	5.24	2.90
<i>Listeria monocytogenes</i> (5-strain mixture)	LM1	8.05	5.02	3.03
	LM2	7.85	5.22	2.63
	LM2	7.82	5.25	2.57
<i>Bacillus cereus</i> (3-strain mixture)	BC1	3.55	3.2	0.35
	BC2	3.61	3.47	0.14
	BC3	3.52	3.47	0.05

Notes:

S-N: all *Salmonella* strains except Newport AM05104S-Tn: all *Salmonella* strains except TennesseeS-Ty1: all *Salmonella* strains except UK-1S-Ty2: all *Salmonella* strains except ATCC700804S-Ty3: all *Salmonella* strains except ATCC14028

(temperature 55°C). *Salmonella* appeared to be more sensitive and less variable to the CHIEF treatment than *E. coli* O157:H7 as their microbial reductions varied from 2.6 to 3.1 log₁₀ CFU/ml. Strains of a Gram-positive pathogen bacteria, *Listeria monocytogenes*, were similarly sensitive to *Salmonella* with average reductions of 2.75 (±0.25). The CHIEF treatment, however, did not seem to be very effective in inactivating spores of *Bacillus cereus*, as no more than 0.35 log CFU/ml spores were inactivated by a single pass. A serial treatment of two consecutive passes through the CHIEF device appeared to have an additive effect on the extent of killing vegetative pathogenic strains, as the final count of *Salmonella* was increased almost twofold from 2.95 to 5.55 average log₁₀ CFU/ml reduction (Table 9.3). This enhanced inactivation, however, was smaller for *Listeria* and *E. coli* O157:H7 as the additional pass only increased kill by 77 and 59%, respectively (Table 9.3), compared with the single-pass treatment (Table 9.2).

9.4.2 Quality

Since no study has been conducted on the effect of CHIEF treatment on milk quality, some relevant data from a study on CHIEF treatment of orange juice in comparison

Table 9.3 Effect of a double-pass CHIEF treatment on viable count of pathogenic bacteria inoculated into skimmed milk (temperature 55–60°C, applied voltage 3.5–4 kV)

Bacteria	Replicate trial number	Initial count (\log_{10} CFU/ml)	Final count (\log_{10} CFU/ml)	Reduction (\log_{10} CFU/ml)
<i>Escherichia coli</i> O157:H7 (5 strain mixture)	ECD1	7.92	3.3	4.62
	ECD2	7.86	3.57	4.29
	ECD3	7.83	3.67	4.16
<i>Salmonella</i> (5-strain mixture)	SD1	7.99	2.48	5.51
	SD2	8.00	2.31	5.69
	SD3	7.97	2.53	5.44
<i>Listeria monocytogenes</i> (5-strain mixture)	LMD1	8.30	3.44	4.86
	LMD2	8.17	3.42	4.75
	LMD3	8.06	3.47	4.59

with high temperature, short time (HTST) treatment and homogenization are therefore presented. This study was focused on the changes in aroma and vitamin C in orange juice after CHIEF treatment. It was found that all samples contained between 12 and 14 odour-active compounds. Selected odour-active compounds as affected by CHIEF and HTST are shown in Figure 9.7. CHIEF and HTST did not destroy any of the odour-active compounds found in the untreated sample. In terms of vitamin C retention, CHIEF treatment performed slightly better than HTST immediately after treatment (Table 9.4). Interestingly, CHIEF treated samples retained almost 13 times more vitamin C than HTST treated samples after three weeks storage at 4.4°C.

**Figure 9.7** Orange juice taste profiles as affected by different treatments (Ion ratio is the ratio of qualifier ion to quantifier ion, which is a quantitative measure and confirmation of the ion used in chromatography and mass spectroscopy analysis).

Table 9.4 Vitamin C retention after CHIEF and HTST treatments

Treatment and storage condition	Vitamin C retention (mg/100 g)
Before treatment	33.3
0 day after HTST	30.8
0 day after CHIEF	31.4
3 weeks at 4.4°C HTST	1.67
3 weeks at 4.4°C CHIEF	21.5
3 weeks at 21°C HTST	15.8
3 weeks at 21°C CHIEF	15.4
3 weeks at 37°C HTST	<0.5
3 weeks at 37°C CHIEF	<0.5

9.5 Other Uses of CHIEF Technology

In addition to milk and orange juice, a whey beverage was also tested using CHIEF technology. Whey is a protein-rich liquid component of milk that is produced as a by-product of cheese making. The health benefits of consuming whey have been recognized (Luhovyy *et al.*, 2007; Smithers, 2008) and the use of whey has been expanded to many functional foods. High protein beverages containing whey are anticipated to be a welcome, healthy product by consumers. However, thermal processing, such as thermal pasteurization, of whey-containing beverages should be avoided. Whey proteins are unstable when subjected to temperatures above 72°C, which denatures the proteins, destroys some of the bioactive compounds and results in instability and reduced health and nutritional values.

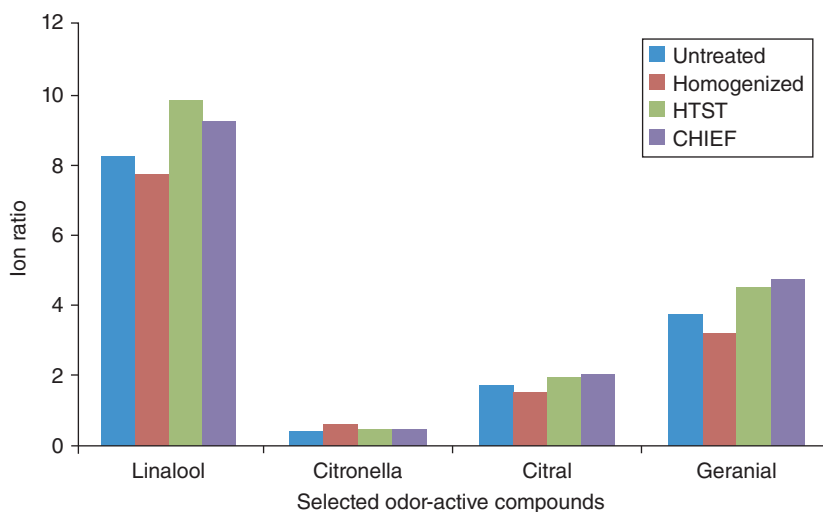
In this study, model whey beverages containing whey and orange juice, or grape juice or apple juice were formulated. The following blends of whey and fruit juice were prepared: 100% whey, 75% whey/25% fruit juice, 50% whey/ 50% fruit juice, 25% whey/75% fruit juice. About 7.5 log₁₀ CFU/ml *E. coli* 25922 were inoculated into the model beverages. The model beverages were subjected to CHIEF treatments with an applied voltage of 30 kV.

The experimental results show that 2–3 and 4–6 log₁₀ *E. coli* vegetative cell reductions were achieved with one pass and two passes of CHIEF treatment, respectively (Table 9.5). Bacterial kill appears to increase with increasing proportions of fruit juice, which may be attributed to the lowered pH and/or diluted protective effect of whey by fruit juice.

9.6 Future Development

CHIEF is a very new technology and little information is available in the scientific literature. Although much of the PEF knowledge from the literature is relevant, rigorous research and development efforts are needed because of the unique electrical power supply and reactor structure of CHIEF, which may present different opportunities and challenges in commercialization of the technology.

Table 9.5 Bacterial count of *E. coli* 25922 inoculated into model whey beverage before and after treatment with CHIEF

Model whey beverages	Initial bacteria count (log CFU/ml)	Bacteria count after one pass (log CFU/ml)	Bacteria count after two passes (log CFU/ml)
100% whey	7.6	5.0	3.2
75% whey/ 25% orange juice	7.4	4.6	2.7
50% whey/ 50% orange juice	7.3	4.0	2.5
25% whey/ 75% orange juice	7.4	3.8	2.1
75% whey/ 25% grape juice	7.4	4.5	2.3
75% whey/ 25% apple juice	7.5	4.3	2.2

9.6.1 Hardware Development

As discussed earlier, CHIEF technology is unique in its power supply and chamber configuration. While AC power supplies with different frequencies are readily available, more work is needed to improve the energy efficiency by matching the inductance of the power supply with the capacitance of system circuit. Different treatment chambers and dielectric materials must be developed and tested for electric field enhancement, energy efficiency, and durability.

9.6.2 Evaluation of the Process

The effects of CHIEF on chemical and physical properties, shelf life stability and sensory quality of milk have not been assessed. Specifically, the impact of CHIEF on enzymes and its relationship to shelf stability and the susceptibility of enzymes, vitamins, lipids and flavours of milk to CHIEF are unknown. For example, the desired flavour of fluid milk is a mild, bland or low flavour intensity product and even very slight changes in the flavour profile of milk can be unacceptable to the consumer. During nonthermal processing off-flavour can develop from enzymatic breakdowns of butterfat to free fatty acids if enzymes are not properly inactivated. Therefore, the effects of the CHIEF process on the chemical and physical properties, enzymatic activities, flavour profile, and shelf life stability of fresh milk, among other issues, must be addressed before the process can be demonstrated on a larger pilot plant scale.

9.6.3 Hurdle Technology

Thermophilic and thermotolerant organisms in milk are able to survive or grow under high temperature conditions (55°C or higher). While the key to controlling thermophilic and thermotolerant organisms in milk is to ensure that proper sanitation methods are used at the farms and plants, once they enter milk they must be inactivated to assure safety. Milk is currently thermally pasteurized under mild conditions to extend its shelf life. However, inactivation of thermophilic and thermotolerant organisms present in milk requires excessive thermal treatment (high temperatures and long processing times), which is detrimental to the nutrients and quality (Bylund, 2003). CHIEF technology may present a good opportunity for inactivating thermophilic and

thermoduric organisms through the synergistic thermal and nonthermal effects of the process. If such treatment is used properly, the thermophilic and thermoduric bacteria counts in raw milk may be reduced before the raw milk reaches dairy processors to prevent further spread of the bacteria in the milk chain.

As mentioned briefly above, CHIEF can be a useful hurdle technology for liquid food preservation due to its low temperature nature. Most of the recent studies on PEF tend to adopt an approach combining multiple factors, such as the addition of heat (Craven *et al.*, 2008; Noci *et al.*, 2009; Yu *et al.*, 2009), antimicrobial compounds (Sobrino-Lopez and Martin-Belloso, 2008; Sobrino-Lopez *et al.*, 2009) and thermosonication (Noci *et al.*, 2009). Positive synergistic effects on bacteria and enzyme inactivation have been demonstrated (Zhang *et al.*, 1995; Aronsson and Rönner 2001; Aronsson *et al.*, 2001; Jayaram *et al.*, 2004). For example, Walkling-Ribeiro *et al.* (2009) examined the hurdle effects of heat and PEF treatments and concluded that moderate heat at 50°C and PEF at a low field strength (40 kV/cm, 60 µs) achieved similar inactivation of native microbiota in milk and longer stabilization of microbiological shelf life than conventional thermal pasteurization. Increasing the inlet temperature of the liquid food therefore decreases treatment time or required PEF strength. The increase in PEF-induced cell death with an increase in temperature was attributed to a reduction in bilayer thickness and an increase in fluidity in cell membranes due to the transition of the phospholipid molecules from a gel to a liquid crystalline phase as the temperature increases, which increases the susceptibility of the membrane to an irreversible breakdown as a result of PEF treatment (Liang *et al.*, 2002). Others suggested that the increase in the rate of inactivation with increasing temperature may be due to the decrease in the electric breakdown potential of the bacterial cell membrane (Coster and Zimmermann, 1975). Furthermore, such synergistic effects not only improve the overall microbial inactivation but also significantly reduce the operation costs through energy saving as much as 60% (Wouters *et al.*, 1999; Heinz *et al.*, 2003).

Acknowledgements

We appreciate Midwest Dairy Foods Research Center and Center for Biorefining for partial support of this work, and thanks to Cargill Corp. and Dr Francisco Diez's group at the Food Science and Nutrition Department for help in evaluating the quality and bacteria numbers for some of the CHIEF treatments.

References

- Aronsson, K. and Rönner, U. (2001) Influence of pH, water activity and temperature on the inactivation of *Escherichia coli* and *Saccharomyces cerevisiae* by pulsed electric fields, *Innovative Food Science & Emerging Technologies*, **2**: 105–112.
- Aronsson, K., Lindgren, M., Johansson, B.R. and Rönner, U. (2001) Inactivation of microorganisms using pulsed electric fields: the influence of process parameters on *Escherichia coli*, *Listeria innocua*, *Leuconostoc mesenteroides* and *Saccharomyces cerevisiae*, *Innovative Food Science & Emerging Technologies*, **2**: 41–54.
- Aronsson, K., Rönner, U. and Borch, E. (2005) Inactivation of *Escherichia coli*, *Listeria innocua* and *Saccharomyces cerevisiae* in relation to membrane permeabilization and

- subsequent leakage of intracellular compounds due to pulsed electric field processing, *International Journal of Food Microbiology*, **99**: 19–32.
- Bai-Lin, Q., Barbosa-Canovas, G.V., Swanson, B.G. *et al.* (1998) Inactivating microorganisms using a pulsed electric field continuous treatment system, *IEEE Transactions on Industry Applications*, **34**: 43–50.
- Barbosa-Cánovas, G.V., Góngora-Nieto, M.M., Pothakamury, U.R. and Swanson, B. (1999) *Preservation of Foods with Pulsed Electric Fields*. Food Science and Technology International Series, Academic Press, San Diego, CA.
- Bendicho, S., Barbosa-Canovas, G.V. and Martin, O. (2003) Reduction of protease activity in milk by continuous flow high-intensity pulsed electric field treatments, *Journal of Dairy Science*, **86**: 697–703.
- Bylund, G. (2003). *Dairy processing handbook*. Tetra Pak Processing Systems AB.
- Calderón-Miranda, M.L., Barbosa-Cánovas, G.V. and Swanson, B.G. (1999) Transmission electron microscopy of *Listeria innocua* treated by pulsed electric fields and nisin in skimmed milk, *International Journal of Food Microbiology*, **51**: 31–38.
- Coster, H.G.L. and Zimmermann, U. (1975) The mechanism of electrical breakdown in the membranes of *Valonia utricularis*, *Journal of Membrane Biology*, **22**: 73–90.
- Craven, H.M., Swiergon, P., Ng, S. *et al.* (2008) Evaluation of pulsed electric field and minimal heat treatments for inactivation of pseudomonads and enhancement of milk shelf-life, *Innovative Food Science & Emerging Technologies*, **9**: 211–216.
- García, D., Gómez, N., Mañas, P. *et al.* (2007) Pulsed electric fields cause bacterial envelopes permeabilization depending on the treatment intensity, the treatment medium pH and the microorganism investigated, *International Journal of Food Microbiology*, **113**: 219–227.
- Geveke, D.J. and Brunkhorst, C. (2004) RFEF pilot plant for inactivation of *Escherichia coli* in apple juice, *Fruit Processing*, **14**(3): 166–171.
- Harrison, S.L., Barbosa-Cánovas, G.V. and Swanson, B.G. (1997) *Saccharomyces cerevisiae* structural changes induced by pulsed electric field treatment, *Lebensmittel-Wissenschaft und-Technologie*, **30**: 236–240.
- Heinz, V., Toepfl, S. and Knorr, D. (2003) Impact of temperature on lethality and energy efficiency of apple juice pasteurization by pulsed electric fields treatment, *Innovative Food Science & Emerging Technologies*, **4**: 167–175.
- Jayaram, S., Castle, G. and Margaritis, A. (2004) Kinetics of sterilization of *Lactobacillus brevis* cells by the application of high voltage pulses, *Biotechnology and Bioengineering*, **40**: 1412–1420.
- Kambiz, S., Versteeg, C., Sherkat, F. and Wan, J. (2008) Alkaline phosphatase and microbial inactivation by pulsed electric field in bovine milk, *Innovative Food Science & Emerging Technologies*, **9**: 217–223.
- Liang, Z., Mittal, G.S. and Griffiths, M.W. (2002) Inactivation of *Salmonella Typhimurium* in orange juice containing antimicrobial agents by pulsed electric field, *Journal of Food Protection*, **65**: 1081–1087.
- Luhovyy, B.L., Akhavan, T. and Anderson, G.H. (2007) Whey proteins in the regulation of food intake and satiety, *Journal of the American College of Nutrition*, **26**: 704S–712S.
- Martin, O., Qin, B., Chang, F. *et al.* (1997) Inactivation of *Escherichia coli* in skim milk by high intensity pulsed electric fields, *Journal of Food Process Engineering*, **20**: 317–336.
- Noci, F., Walkling-Ribeiro, M., Cronin, D.A. *et al.* (2009) Effect of thermosonication, pulsed electric field and their combination on inactivation of *Listeria innocua* in milk, *International Dairy Journal*, **19**: 30–35.

- Pothakamury, U.R., Barbosa-Canovas, G.V., Swanson, B.G. and Spence, K.D. (1997) Ultrastructural changes in *Staphylococcus aureus* treated with pulsed electric fields / Cambios ultraestructurales en *Staphylococcus aureus* sometida a campos electricos pulsantes, *Food Science and Technology International*, **3**: 113–121.
- Qin, B.L., Pothakamury, U.R., Barbosa-Canovas, G.V. and Swanson, B.G. (1996) Nonthermal pasteurization of liquid foods using high-intensity pulsed electric fields, *Critical Reviews in Food Science & Nutrition*, **36**: 603–627.
- Qin, B.L., Barbosa-Canovas, G.V., Swanson, B.G. *et al.* (1998) Inactivating microorganisms using a pulsed electric field continuous treatment system, *IEEE Transactions on Industry Applications*, **34**: 43–50.
- Ruan, R., Deng, S., Chen, L. *et al.* (2008). Dielectric barrier reactor having concentrated electric field. UP Office, University of Minnesota, MN.
- Smithers, G.W. (2008) Whey and whey proteins – From ‘gutter-to-gold’, *International Dairy Journal*, **18**: 695–704.
- Sobrinho-Lopez, A. and Martin-Belloso, O. (2008) Enhancing the lethal effect of high-intensity pulsed electric field in milk by antimicrobial compounds as combined hurdles, *Journal of Dairy Science*, **91**: 1759–1768.
- Sobrinho-Lopez, A., Viedma-Martinez, P., Abriouel, H. *et al.* (2009) The effect of adding antimicrobial peptides to milk inoculated with *Staphylococcus aureus* and processed by high-intensity pulsed-electric field, *Journal of Dairy Science*, **92**: 2514–2523.
- Ukuku, D.O., Geveke, D.J., Cooke, P. and Zhang, H.Q. (2008) Membrane damage and viability loss of *Escherichia coli* K-12 in apple juice treated with radio frequency electric field, *Journal of Food Protection*, **71**: 684–690.
- Vega-Mercado, H., Martin-Belloso, O., Bai-Lin, Q. *et al.* (1997) Non-thermal food preservation: pulsed electric fields, *Trends in Food Science & Technology*, **8**: 151–157.
- Walkling-Ribeiro, M., Noci, F., Cronin, D. *et al.* (2009) Antimicrobial effect and shelf life extension by combined thermal and pulsed electric field treatment of milk, *Journal of Applied Microbiology*, **106**: 241–248.
- Wouters, P.C., Dutreux, N., Smelt, J.P.P.M. and Lelieveld, H.L.M. (1999) Effects of pulsed electric fields on inactivation kinetics of *Listeria innocua*, *Applied and Environmental Microbiology*, **65**: 5364–5371.
- Yu, L.J., Ngadi, M. and Raghavan, G.S.V. (2009) Effect of temperature and pulsed electric field treatment on rennet coagulation properties of milk, *Journal of Food Engineering*, **95**: 115–118.
- Zhang, Q., Barbosa-Cánovas, G.V. and Swanson, B.G. (1995) Engineering aspects of pulsed electric field pasteurization, *Journal of Food Engineering*, **25**: 261–281.

10

Bacteriocins of Food Grade Lactic Acid Bacteria in Hurdle Technology for Milk and Dairy Products

John A. Renye, Jr and George A. Somkuti

Dairy and Functional Foods Research Unit, USDA/ARS/ERRC, USA

10.1 Introduction

The use of high temperature, short time (HTST) pasteurization has proven effective in eliminating microbial contaminants from raw milk. However, some thermotolerant bacteria, such as *Enterococci*, *Micrococci*, and spore-formers, including *Bacillus* and *Clostridium* species, have been reported to survive pasteurization in low numbers. The eventual growth of these contaminating bacteria may decrease the shelf life of fluid milk and other dairy foods due to spoilage or safety concerns. Furthermore, improper pasteurization, post-pasteurization contamination or the consumption of nonpasteurized (raw-milk) dairy foods have been associated with outbreaks of food-borne illness. A recent study on the consumption of contaminated food commodities in the United States, cited dairy as the second most frequent source for illness and deaths, and the most common source for hospitalizations (Painter *et al.*, 2013). Another US Centers for Disease Control and Prevention (CDC) report published in 2012, looked at 121 dairy-related outbreaks of food-borne illness from 1993 to 2006 where the pasteurization status of the contaminated foods was known. Of these outbreaks, 48 were associated with the consumption of pasteurized dairy products, and resulted in 2842 cases of illness, 37 hospitalizations and one death. The remaining 73 outbreaks were associated with nonpasteurized dairy foods and resulted in 1571 cases, 202 hospitalizations and two deaths (Langer *et al.*, 2012). Surveys conducted during this period reported that less than 1% to 1.5% of respondents consumed nonpasteurized milk

(CDC, 2008a, 2008b; Shiferaw *et al.*, 2000), thus it was concluded that the occurrence of outbreaks involving nonpasteurized dairy foods were significantly higher than those involving pasteurized foods (150 times higher per unit of dairy product consumed) (Langer *et al.*, 2012). In all cases associated with the consumption of nonpasteurized dairy foods, the causative agent was determined to be one of the following pathogenic bacteria: *Campylobacter* spp., Shiga toxin producing *Escherichia coli*, *Salmonella* spp., *Brucella* spp., *Shigella* spp., or *Listeria* spp. However, in outbreaks involving pasteurized dairy foods the most common causative agent was norovirus (13 of 73), with the remainder of the outbreaks associated with the presence of a pathogenic bacteria (Langer *et al.*, 2012).

To improve both the shelf life and safety of milk and fermented dairy products, efforts are continuing to develop effective technologies for the elimination of microbial contaminants. In addition, there is a growing demand by consumers to reduce the number of chemical preservatives used in foods, and to find alternatives to thermal processing, including pasteurization, since it is believed to negatively affect the organoleptic and nutritional quality of milk. For example, ultra high temperature (UHT) pasteurization has been shown to effectively eliminate microbial pathogens from milk, thus resulting in a safe product with a considerably longer shelf life than conventional milk. However, the process has also been reported to destroy some of the vitamin and protein content in milk and result in an unusual cooked flavor due to Maillard reactions between lactose and milk proteins and the isomerization of lactose to lactulose (Nursten, 1997). Although UHT milk has been accepted in many European countries, the consequences of this process have made it less desirable in the United States. With this in mind, the dairy industry has continued to search for new technologies that incorporate natural biopreservatives, which can be used to prevent microbial contamination in pasteurized and raw milk products, without affecting food quality. A recent review summarized the potential of several natural antimicrobials of animal, plant or microbial origin for use as food preservatives (Juneja *et al.*, 2012). Microbial agents which have been approved by the US Food and Drug Administration (FDA) as food-grade preservatives include two phage cocktails active against *Listeria monocytogenes*, Listex (EBI Food Safety, www.ebifoodsafety.com) and LMP 102 (Intralytics, www.intralytics.com), and nisin, a peptide antimicrobial produced by *Lactococcus lactis*. The phage products have been approved for use in ready-to-eat meats (Garcia *et al.*, 2010b), while Nisaplin (Danisco, www.danisco.com), the semi-purified nisin preparation has been approved for use in a variety of foods including dairy products. Although nisin is the only FDA-approved bacteriocin for use in food production, several other food-grade lactic acid bacteria are known to produce bacteriocins which are believed to have potential as natural food preservatives.

10.2 Bacteriocin Structure and Production

Bacteriocins were originally defined as ribosomally synthesized antimicrobial peptides with activity against closely related bacterial species (Tagg *et al.*, 1976). However, several bacteriocins produced by lactic acid bacteria (LAB) have been shown to possess broad spectrum activity against Gram-positive food-borne pathogens, including *Listeria monocytogenes* and *Staphylococcus aureus* (Chen and Hoover, 2003), and, to a lesser extent, against Gram-negative food-borne pathogens, such as *E. coli* and

Yersinia species (Miteva *et al.*, 1998; Batdorj *et al.*, 2006). This broad spectrum activity, along with the fact that LAB commonly used in the production of foods have been designated as GRAS (generally recognized as safe) microorganisms, has resulted in a growing interest to use these bacteriocins as natural, food-grade biopreservatives. Since LAB have been identified as indigenous members of the raw milk microflora of cows, buffalo, sheep and goats (Aziz *et al.*, 2009; Ortolani *et al.*, 2010; Delavenne *et al.*, 2012), raw milk and its fermented products are continuously being mined for the isolation of novel bacteriocin producing cultures (Table 10.1). In addition, the growing number of fully sequenced genomes of food-grade bacteria has allowed for the use of genomics to screen the chromosome for gene clusters potentially involved in the production of novel bacteriocins (Nes and Johnsborg, 2004). This technique successfully identified the bacteriocin-like peptide (*blp*) gene cluster in several strains of *Streptococcus thermophilus*, which were originally classified as nonbacteriocin producers (Hols *et al.*, 2005). Further studies involving these strains led to the discovery that *S. thermophilus* LMD-9 was capable of producing a novel broad spectrum bacteriocin, designated thermophilin 9 (Fontaine *et al.*, 2007).

Originally it was proposed that LAB bacteriocins be grouped into four distinct classes (Klaenhammer 1993) but more recently a modified classification scheme was proposed which eliminated the Class III and Class IV categories (Cotter *et al.*, 2005b). In both classification schemes the Class I and Class II bacteriocins are broadly categorized as lantibiotics and unmodified peptides, respectively, but the latter scheme suggests that large, heat-labile antimicrobial proteins, such as helvectin J (Joerger and Klaenhammer, 1986) and enterolysin A (Nilsen *et al.*, 2003), no longer be categorized as Class III bacteriocins but instead as bacteriolysins. Class IV bacteriocins were originally categorized by their requirement of nonproteinaceous moieties (e.g. carbohydrates or lipids) for activity but the lack of convincing evidence for existence of such antimicrobial peptides was cited as the reason they were not included in the updated classification scheme (Cotter *et al.*, 2005b).

Class 1 bacteriocins are small peptides that undergo post-translational modifications. They are collectively referred to as lantibiotics due to the presence of lanthionine and β -methyllanthionine rings that arise from a condensation reaction between the sulfhydryl group of cystine and a nearby dehydrated serine (dehydroalanine) or threonine (dehydrobutyrine) respectively (Ingram 1969; Sahl and Bierbaum, 1998; Cotter *et al.*, 2005b). Lantibiotics are further subcategorized based on their structure and mode of action, with several subgroups proposed over the years. Initially it was suggested that lantibiotics be grouped as either type A, which included elongated amphiphilic cationic peptides that act by forming pores within the cell membrane of their target bacterium, or type B, which included small, globular peptides with a negative or no net charge and are thought to act by inhibiting specific enzymes (Chen and Hoover, 2003). However, with more information becoming available on lantibiotics, several alternative grouping schemes have been proposed that include six (Twomey *et al.*, 2002), eight (Guder *et al.*, 2000) or eleven (Cotter *et al.*, 2005a) subcategories. In the newer schemes both nisin and lactacin 481, which were originally grouped as type A lantibiotics, are the names of individual subcategories, with the lactacin 481 group containing the largest number of lantibiotics (Cotter *et al.*, 2005a). Both nisin and lactacin 481 were shown to use lipid II of target bacteria as a docking molecule, which results in the inhibition of peptidoglycan synthesis (Wiedemann *et al.*, 2001; Bottiger *et al.*, 2009; Islam *et al.*, 2012; Knerr *et al.*, 2012). However, of the two, only nisin forms a direct bond with the pyrophosphate moiety of lipid II (Hsu *et al.*, 2004) that allows

Table 10.1 Recent examples of bacteriocin producing lactic acid bacteria (LAB) isolated from dairy products

LAB	Dairy Product	Targeted Food Pathogens	References
<i>P. acidilactici</i> Kp10	Fermented Milk	<i>L. monocytogenes</i>	Abbasiliasi <i>et al.</i> , 2012
<i>Enterococcus mundtii</i> CRL35 <i>E. faecium</i> ST88Ch	Cheese	<i>L. monocytogenes</i>	Vera Pingitore <i>et al.</i> , 2012
<i>L. lactis</i> ssp. <i>lactis</i> LL171	Tulum cheese	<i>L. monocytogenes</i> , <i>S. aureus</i> , <i>Clostridium perfringens</i>	Kumari <i>et al.</i> , 2012
<i>L. lactis</i> ssp. <i>lactis</i> (6 strains)	Raw ewes and goat milk, and cheese	<i>L. monocytogenes</i>	Cosentino <i>et al.</i> , 2012
<i>Lactobacillus</i> spp. (21 strains)	Raw milk and cheese	<i>L. monocytogenes</i> , <i>S. aureus</i>	Perin <i>et al.</i> , 2012
<i>E. faecalis</i> UGRA10	Spanish sheep cheese	<i>L. monocytogenes</i>	Cebrian <i>et al.</i> , 2012
<i>Leuconostoc mesenteroides</i> 406	Fermented mare's milk	<i>L. monocytogenes</i> , <i>C. botulinum</i>	Wulijideligen <i>et al.</i> , 2012
<i>Enterococcus durans</i> A5-11	Fermented mare's milk	<i>Fusarium culmorum</i> , <i>Penicillium roqueforti</i> , <i>Debaryomyces hansenii</i> <i>E. coli</i> , <i>S. aureus</i> , <i>L. innocua</i>	Belguesmia <i>et al.</i> , 2013 Batdorj <i>et al.</i> , 2006
<i>E. durans</i> 41D	Raw milk cheese	<i>L. monocytogenes</i>	Du <i>et al.</i> , 2012
<i>Lactobacillus brevis</i> BG18 <i>Lb. plantarum</i> BG33	Tulum cheese	<i>L. monocytogenes</i> , <i>C. botulinum</i> , <i>S. aureus</i> , <i>B. cereus</i>	Uymaz <i>et al.</i> , 2011
<i>L. lactis</i> ssp. <i>lactis</i> (16 strains)	Raw milk cheeses	<i>L. innocua</i> , <i>S. aureus</i>	Alegria <i>et al.</i> , 2010
<i>L. lactis</i> (18 strains) <i>Lb. plantarum</i> (2 strains)	Raw milk and soft cheese	<i>L. monocytogenes</i>	Ortolani <i>et al.</i> , 2010
<i>Lactococcus</i> sp. strain QU12	Cheese	<i>Enterococcus</i> sp, <i>Pediococcus</i> sp., <i>Bacillus</i> sp., <i>L. monocytogenes</i>	Sawa <i>et al.</i> , 2009

for subsequent insertion within the target cell membrane leading to the formation of pores (Breukink *et al.*, 1999; Wiedemann *et al.*, 2001). In addition, it has been reported that nisin, and possibly other lantibiotics, can bind with lipid III and lipid IV to further prevent cell wall biosynthesis (Muller *et al.*, 2012). Other examples of the new grouping scheme for lantibiotics include the separation of formerly type B, or globular, peptides into the mersacidin and cinnamycin subgroups and the two-component lantibiotics, including lacticin 3147, into the LtnA2 subgroup (Cotter *et al.*, 2005a). In the case of lacticin 3147, which is naturally produced by *L. lactis* (Ryan *et al.*, 1996), studies have shown that mutations which disrupt the ring structure of either peptide render the lantibiotic inactive (Cotter *et al.*, 2006; Wiedemann *et al.*, 2006).

Class II bacteriocins are broadly categorized as small, heat-stable peptides that do not undergo extensive post-translational modifications. Their antimicrobial activity is dependent on their cationic nature, which allows for interactions with anionic lipids of the target bacterium's cell membrane, resulting in pore formation and subsequent dissipation of proton motive force, ATP depletion and leakage of nutrients and metabolites (Eijsink *et al.*, 2002). Binding of class II bacteriocins to the target cell membrane is thought to occur by electrostatic interactions (Chen *et al.*, 1997) and, in some cases, involves a specific receptor that is a component of the mannose–phosphotransferase system (PTS) (Ramnath *et al.*, 2000; Dalet *et al.*, 2001; Hechard *et al.*, 2001; Diep *et al.*, 2007). Further studies have shown that the C-terminal region of class II bacteriocins (Kazazic *et al.*, 2002; Johnsen *et al.*, 2005) and sequence variation within the mannose–PTS IIC and IID subunits of enzyme II are essential in determining the antimicrobial spectrum (Kjos *et al.*, 2009).

Class II bacteriocins are further grouped based on their structure and antimicrobial activity, with class IIa bacteriocins commonly referred to as pediocin-like peptides, and share a high specificity for inhibiting the growth of *Listeria monocytogenes* (Montville and Chen, 1998; Hechard and Sahl, 2002). Pediocin (PA-1/AcH), sakacin (A/P) and enterocin A are examples of these bacteriocins, which are characterized by a conserved YGNGVXCXXXXCXV (residues 3–16 of mature peptide) amino acid sequence motif within their N-terminal region (Nieto Lozano *et al.*, 1992; Eijsink *et al.*, 1998). Disulfide bridges have been shown to occur between the two cysteine residues (C) within this motif, and positively charged amino acids at residues 11 and 12 are involved in the nonspecific electrostatic interactions, which allow the peptide to bind with the cell membrane of susceptible bacteria (Chen *et al.*, 1997; Kazazic *et al.*, 2002). The hydrophobic or amphiphilic C-terminal domain of class IIa bacteriocins is required for pore formation within the target cell membrane (Fimland *et al.*, 1996; Miller *et al.*, 1998) and regulates non-*Listeria* target cell specificity (Fimland *et al.*, 2000; Johnsen *et al.*, 2005).

Class IIb bacteriocins are defined as two-component bacteriocins and require the presence of two distinct peptides for optimal antimicrobial activity. Examples of class IIb bacteriocins include lactococcin G from *Lactococcus lactis* (Nissen-Meyer *et al.*, 1992) and plantaricin S from *Lactobacillus plantarum* (Jimenez-Diaz *et al.*, 1995). The remaining class II bacteriocins, which do not meet the criteria for class IIa or IIb designation, were once grouped as IIc, 'other peptide bacteriocins' (Eijsink *et al.*, 2002) and later suggested to be divided into two subclasses: class IIc, cyclic peptides, and class IID, nonpediocin single linear peptides (Cotter *et al.*, 2005b). Classification schemes will most likely continue to change as more novel bacteriocins are discovered. For example, thermophilin 9 from *Streptococcus thermophilus* appears to be a class II bacteriocin; however, optimal antimicrobial activity is dependent on the presence of an

essential peptide (BlpD) and multiple enhancer peptides which structurally appear like individual bacteriocins (Blp E, F, U). In addition, the activity of a thiol-disulfide oxidase is required for antilisterial activity (Fontaine and Hols, 2008). Further studies on thermophilin 9 and similar peptides are required to determine if they would fit within the present classification schemes or require new subclasses.

Regardless of their class, bacteriocins are commonly expressed as pre-peptides with an amino acid leader sequence present at the N-terminus. This leader peptide is thought to serve multiple roles including: (i) maintaining the peptide in an inactive form within the host cell, (ii) directing the translocation of the pre-peptide to the transport system required for secretion of the mature bacteriocin and (iii) assisting with the post-translation modification of lantibiotics (van der Meer *et al.*, 1994; Xie *et al.*, 2004). More recently it was shown that the leader peptide can act *in trans* to allow for proper post-translational modification of lantibiotics, suggesting its role may be to stabilize the interaction between the peptide and modification enzyme(s) (Oman *et al.*, 2012). Bacteriocin secretion is often carried out by a dedicated membrane-associated ABC transporter which includes a proteolytic domain responsible for removing the leader peptide (Havarstein *et al.*, 1995). For both class I and II bacteriocins these peptide-specific export systems are normally encoded within the same gene cluster that is responsible for bacteriocin production, with nisin and pediocin as examples (van der Meer *et al.*, 1993; Venema *et al.*, 1995). An alternative export scheme involves the presence of a bacteriocin leader peptide recognized by the host cell's general secretion (*sec*) pathway, as reported for durancin GL from *Enterococcus durans* 41D (Du *et al.*, 2012). More recently it has been reported that some bacteriocins are produced without N-terminal leader peptides, including enterocin L50AB (Cintas *et al.*, 1998) and weissellicins M and Y (Masuda *et al.*, 2011), suggesting the possibility of a novel transport system for these antimicrobial peptides (Masuda *et al.*, 2012).

The gene clusters responsible for bacteriocin production can differ greatly depending on several factors, including the number of bacteriocins encoded within the cluster and the number of genes required for regulating expression, secretion and post-translational modifications. Lantibiotic gene clusters have been shown to include anywhere from seven (lacticin 481) to eleven (nisin) genes (Piard *et al.*, 1993; Ra *et al.*, 1996; Siezen *et al.*, 1996; Rince *et al.*, 1997), while class II bacteriocin clusters containing anywhere from two (durancin GL) to greater than twenty (plantaricin A; thermophilin 9) genes have been identified (Diep *et al.*, 1996; Eijsink *et al.*, 1998; Fontaine and Hols 2008; Du *et al.*, 2012). Common to most class I and class II bacteriocin gene clusters is the presence of genes encoding for host cell immunity. Genes encoding for individual immunity proteins are often immediately downstream and within the same operon as the gene encoding the bacteriocin, although some exceptions have been reported (Franz *et al.*, 2000). Typically these proteins act by either binding and sequestering the bacteriocin, or binding to a cell membrane receptor utilized for docking. For class IIa bacteriocins it was reported that the immunity protein binds to the Man-PTS receptor, and locks any bound bacteriocin to the receptor, thus preventing pore formation (Diep *et al.*, 2007). Another immunity mechanism reported for lantibiotics and some class II bacteriocins requires the presence of a specific ABC transport system for pumping the bacteriocin from the host cell membrane (Rince *et al.*, 1997; Guder *et al.*, 2002; Diaz *et al.*, 2003; Gajic *et al.*, 2003; Stein *et al.*, 2005). For some lantibiotics, including nisin, both a specific immunity peptide and ABC transport system are required for optimal host immunity (Alkhatib

et al., 2012). Finally, for some class IIb bacteriocins a third immunity mechanism has been described; it involves the role of specific transmembrane proteases (Kjos *et al.*, 2010).

Another component of several bacteriocin gene clusters is the presence of a two-component quorum sensing system that regulates production and immunity. In these systems an induction factor (IF) or pheromone is constitutively secreted from the host bacterium until a high cell density is reached, at which point the concentration of IF surpasses a threshold level resulting in the production of bacteriocin (Kleerebezem and Quadri, 2001). The IF that regulates this autoinduction loop can either be the bacteriocin itself, as in the case of nisin (Kuipers *et al.*, 1995), or a dedicated pheromone peptide, as seen in the production of enterocin A (Nilsen *et al.*, 1998). In either case, the IF binds to a membrane bound histidine kinase, which subsequently phosphorylates a specific transcriptional regulator that induces bacteriocin expression. In most these QS systems are essential for bacteriocin production; for example, *S. thermophilus* LMD-9 appears to possess all genes necessary for bacteriocin production, yet its thermophilin is not produced under standard laboratory conditions because the pheromone peptide fails to reach a threshold level. Furthermore, supplementation of the growth medium with synthetic pheromone resulted in bacteriocin expression (Fontaine *et al.*, 2007). Additionally, it has been reported that transcriptional regulation may involve multiple response regulators (Diep *et al.*, 2003) or repressors from the xenobiotic response element (Xre) family (McAuliffe *et al.*, 2001; Kreth *et al.*, 2004).

10.3 Application of Bacteriocins in Dairy Foods

The potential for using bacteriocins as natural preservatives, or functional food ingredients that influence organoleptic qualities by regulating the growth of starter and nonstarter LAB (i.e. accelerated ripening or flavour development in cheese (Garde *et al.*, 2002; O'Sullivan *et al.*, 2003a)), has been described in several review articles (Cleveland *et al.*, 2001; Chen and Hoover, 2003; Cotter *et al.*, 2005b; De Vuyst and Leroy, 2007; Sobrino-Lopez and Martin-Belloso, 2008b; Mills *et al.*, 2011b). Characteristics of bacteriocins considered suitable for these applications include: (i) a broad spectrum of activity or specific activity against a targeted pathogen (i.e. class IIA activity against *Listeria monocytogenes*), (ii) heat stability, (iii) naturally produced by a GRAS bacterium, and (iv) no associated health risks for the consuming organism (Cotter *et al.*, 2005b). In addition, environmental conditions within food matrices must be taken into consideration, as they have been shown to affect bacteriocin activity, solubility and stability (Galvez *et al.*, 2007b). For example, nisin has been shown to be more active at a low pH, making it an ideal choice for use in acidic foods (Rayman *et al.*, 1983; Liu and Hansen, 1990); and nisin was shown to be more effective than pediocin AcH in controlling artificial contamination of raw pork, presumably due to the rapid degradation of pediocin by endogenous meat proteases (Murray and Richard, 1997). Environmental factors can also influence bacteriocin expression as it has been reported that growth conditions (e.g. temperature, pH, nutrients, salt) can affect the quorum sensing systems required for the production of several bacteriocins (Brurberg *et al.*, 1997; Nilsen *et al.*, 1998; Diep *et al.*, 2000). The term 'competition sensing' has been proposed to describe how bacteria can sense specific stresses, such as nutrient limitations or secretions from damaged cells, which induce the expression of

bacteriocins as a survival mechanism (Cornforth and Foster, 2013). Given the numerous factors that can affect bacteriocin expression and activity, there remains a demand for research aimed at identifying novel antimicrobial peptides and optimizing their potential in food applications.

10.3.1 Applications to Improve Food Safety

The incorporation of bacteriocins within food can be accomplished by three distinct methods: (i) direct addition of a purified or partially purified bacteriocin, (ii) addition of a bacteriocin-containing fermentate or (iii) use of a food-grade, bacteriocin-producing LAB as a starter or adjunct culture for *in situ* peptide expression. Although several bacteriocins could be classified as GRAS due to their producing bacteria having a history of common use in the production of fermented foods, the purified peptides have not been studied extensively with regard to efficacy, potential toxicity and cross-resistance with other antimicrobials. For this reason nisin was included in the European food additive list (EFSA, 2006) and later approved by the US Food and Drug Administration (FDA, 2013), and remains the only bacteriocin approved by the World Health Organization for direct use as a food preservative. Based on toxicity studies (Frazer *et al.*, 1962; Claypool *et al.*, 1966; Fowler 1973; Shtenberg, 1973) the FDA reported that nisin was safe for human consumption at an Acceptable Daily Intake of 2.9 mg/person/day (FDA, 1988). The most common form of nisin used in food production is Nisaplin (Danisco), which consists of 2.5% nisin, 77.5% NaCl, and nonfat dried milk (12% protein and 6% carbohydrate). The maximum limit for nisin within foods varies depending on the product and country, for example in the United States the maximum limit is 10 000 IU/g for processed cheese; however, no limit exists for the same product in Australia, France and Great Britain (Cleveland *et al.*, 2001). Some examples of the effectiveness of nisin as a natural preservative in dairy foods include: inhibiting the outgrowth of spores of *Clostridia* in cheese spreads (Schillinger *et al.*, 1996; Wessels *et al.*, 1998) and *Bacillus* spores in milk (Wandling *et al.*, 1999) and processed cheese (Plockova *et al.*, 1996); inhibiting the growth of *Listeria monocytogenes* in cottage (Ferreira and Lund, 1996), cheddar (Benech *et al.*, 2002) and ricotta cheeses (Davies *et al.*, 1997); and inhibiting the growth of *L. monocytogenes* in nonfat dry milk and yogurt (Benkerroum *et al.*, 2003). The shelf life of ricotta cheese made with 2.5 mg/l nisin has also been tested; *L. monocytogenes* growth was suppressed for up to eight weeks when stored at 6–8°C. In addition, nisin maintained between 68–90% of its activity after 10 weeks of storage, demonstrating the stability of nisin within fermented dairy foods (Davies *et al.*, 1997).

Pediocin PA1/AcH is an antimicrobial peptide naturally produced by *Pediococcus acidilactici* strains and has been shown to inhibit the growth of *L. monocytogenes* in dairy foods, including cottage cheese, half-and-half cream and cheese sauce (Pucci *et al.*, 1988). Although pediocin is not approved as a food ingredient it has been used commercially in the form of ALTA™ 2431 (Quest). ALTA™ 2431 is a fermentate powder containing pediocin PA-1 and has tested in the production of Mexican Queso Blanco to prevent the growth of *Listeria* (Glass *et al.*, 1995). In addition to pediocin, other dairy-based fermentates have been studied for their potential to serve as natural food preservatives due to the presence of a LAB bacteriocin, including enterocin AS-48 (Ananou *et al.*, 2008), pisciocin CS526 (Azuma *et al.*, 2007) and lacticin 3147 (Morgan *et al.*, 2001). Lacticin 3147, which was initially isolated from *Lactococcus lactis* subsp. *lactis* DPC3147 (McAuliffe *et al.*, 1998), has been studied extensively for its

potential to serve as a preservative in fermented dairy foods since it was reported to maintain at least 50% of its activity at a pH of 5.0 (Ryan *et al.*, 1996) and was not affected by pasteurization (Morgan *et al.*, 1999). A demineralized whey powder fermentate containing lacticin 3147 was reported to inhibit the growth of *Listeria* in dairy foods, with no viable bacteria detected after 60 minutes in yogurt and 85% non-viable cells in cottage cheese after 120 minutes (Morgan *et al.*, 2001). The same powder preparation was shown to kill more than 99% of *L. monocytogenes* in an infant milk formulation within three hours (Morgan *et al.*, 1999).

Due to stringent regulations regarding the development of purified bacteriocins as food ingredients, an emphasis remains on the potential for using bacteriocin producing LAB as starter or adjunct cultures to improve the safety of meat, fish and dairy foods (Chen and Hoover, 2003). Fermented dairy products made with bacteriocin producing strains of common starter cultures have been shown improve the hygienic quality of food. *In situ* production of a bacteriocin by *S. thermophilus* B directly within yogurt was reported to inhibit the growth of *L. monocytogenes* and extend the shelf life by five days (Benkerroum *et al.*, 2002). The use of nisin-producing lactococci as starter cultures was shown to inhibit the growth of *L. monocytogenes* in processed cheese and cheese spreads (Zottola *et al.*, 1994) and methicillin-resistant *Staphylococcus aureus* and *Clostridium tyrobutyricum* in Spanish cheeses (Rilla *et al.*, 2003, 2004). Adjunct cultures have also been shown to inhibit the growth of spoilage and pathogenic bacteria due to their production of bacteriocins within dairy foods. *Streptococcus macedonicus* ACA-DC 198, which produces multiple bacteriocins (Georgalaki *et al.*, 2013), was shown to prevent the outgrowth of *Clostridium* spores within Kesseri cheese (Anastasiou *et al.*, 2009); *Lactobacillus plantarum* LMG P-26358 inhibited the growth of *Listeria innocua* in laboratory-scale cheeses (Mills *et al.*, 2011a); *Enterococcus faecalis* strains AS-48 and INIA 4 were shown to prevent the growth of *Bacillus cereus* (Munoz *et al.*, 2004) and *L. monocytogenes* (Nunez *et al.*, 1997) respectively, in cheese; and *Enterococcus faecium* strains CCM4231, 7C5 and F58 have been shown to protect against *Listeria* contamination in yogurt and cheese (Giraffa *et al.*, 1995; Laukova *et al.*, 1999; Achemchem *et al.*, 2006), with *E. faecium* CCM 4231 also inhibiting the growth of *S. aureus* in skimmed milk and yogurt (Laukova *et al.*, 1999).

10.3.2 Sensory Effects of Bacteriocin Applications

Bacteriocin peptides have not been reported to negatively affect the sensory qualities of food. However, their antimicrobial activities have been tested for the potential to improve food quality and flavour by (i) inhibiting the growth of nonstarter lactic acid bacteria (NSLAB) and (ii) inducing an autolysis of starter cultures leading to an increased release of enzymes. With regard to dairy foods, these studies have focused on cheese production. Unregulated growth of NSLAB during cheese ripening can lead to the production of calcium lactate crystals, volatile compounds and gas, thus resulting in an inferior product with off-flavours and an altered physical appearance (i.e. cracking or splitting). Several studies have shown that these detrimental effects can be lessened in Cheddar cheese when a bacteriocin producing starter or adjunct culture was included to reduce the levels of NSLAB (Uljas and Luchansky, 1995; Ryan *et al.*, 1996; O'Sullivan *et al.*, 2003a). In addition, it was reported that the use of a lacticin 3147-producing strain could improve the development of a reduced-fat Cheddar cheese by controlling the growth of NSLAB and allowing for an accelerated ripening at 12°C, which would result in a more cost effective process (Fenelon *et al.*, 1998).

Lysis of starter cultures has also been reported to affect the organoleptic qualities of cheese due to the release of intracellular proteinases and peptidase (Wilkinson *et al.*, 1994). This concept has been applied to the production of Cheddar cheese, where the addition of *L. lactis* DPC3286, which produces lactococcins A, B and M, was shown to lyse the starter culture *L. lactis* HP, resulting in a cheese with increased concentrations of free amino acids and lactate dehydrogenase (Morgan *et al.*, 1997, 2002). The experimental cheese was reported to have creamy and buttery flavor characteristics and decreased bitterness, which contributed to its higher sensory evaluation scores when compared with a control cheese not containing *L. lactis* DPC3286 (Morgan *et al.*, 2002). In a separate study, *L. lactis* CNRZ481, which produces lacticin 481, was shown to lyse the Cheddar cheese starter culture *L. lactis* HP, resulting in a less bitter and more flavourful cheese when compared with a control cheese (O'Sullivan *et al.*, 2003a). Inclusion of bacteriocin-producing strains *E. faecalis* INIA 4 or *L. lactis* subsp. *lactis* INIA 415 in the production of Hispanic-style cheeses has also been reported to result in cheeses with improved flavour intensity and quality scores when compared to control cheeses (Oumer *et al.*, 2001; Garde *et al.*, 2002); and the use of *L. lactis* IFPL105, which produces lacticin 3147, was reported to increase proteolysis in goat's milk cheese due to lysis of the starter culture (Martinez-Cuesta *et al.*, 1998).

10.3.3 Bacteriocin Resistance

Although bacteriocins have been shown to successfully act as natural food preservatives, there is concern that targeted spoilage and pathogenic bacteria will become resistant to these antimicrobials after repeated exposure. Resistance to nisin has been reported after serial exposure to the lantibiotic for *Clostridium botulinum* (Mazzotta *et al.*, 1997), *Streptococcus pneumoniae* (Severina *et al.*, 1998) and *L. innocua* (Maisnier-Patin and Richard, 1996); however, spontaneous resistance was also reported as part of an adaptive response to other environmental stresses (Crandall and Montville, 1998; Van Schaik *et al.*, 1999; Li *et al.*, 2002). In *L. monocytogenes*, nisin resistance was frequently associated with a change in the bacterium's cell membrane leading to an altered fluidity (Mazzotta *et al.*, 1997; Mazzotta and Montville, 1997) or charge (Ming and Daeschel, 1993, 1995) and/or a change in cell wall thickness (Maisnier-Patin and Richard, 1996) or charge (Abachin *et al.*, 2002). These changes in the cell envelope are expected to prevent the binding of nisin with its intended receptor molecule, lipid II, and may explain why nisin resistance has not been correlated with a direct change in the lipid II concentrations within the target bacterium (Kramer *et al.*, 2004). Regulation of these resistance mechanisms has been linked to: the expression of two component signal transduction systems in *L. monocytogenes* (Cotter *et al.*, 2002) and *Lactobacillus casei* (Revilla-Guarinos *et al.*, 2013); sigma factors (σ^M , σ^W , σ^X), which regulate extracytoplasmic function in *Bacillus subtilis* (Cao and Helmann, 2004; Kingston *et al.*, 2013); the *dlt* operon, which regulates d-alanylation of teichoic acids, in *Streptococcus pneumoniae*, *Staphylococcus aureus*, *Bacillus cereus* and *Clostridium difficile* (Peschel *et al.*, 1999; Kovacs *et al.*, 2006; Abi Khattar *et al.*, 2009; McBride and Sonenshein 2011); penicillin binding proteins in *L. monocytogenes* (Gravesen *et al.*, 2001, 2004); glucosyltransferases in *S. aureus* (Blake and O'Neill, 2013); and the enzyme nisinase, reported to directly degrade nisin (Jarvis, 1967), in *Bacillus* species.

Similar to what was observed for lantibiotics, changes in cell membrane fluidity (Vadyvaloo *et al.*, 2002) and cell surface charge (Vadyvaloo *et al.*, 2004a) have been implicated in the resistance to class II bacteriocins. However, a unique resistance mechanism has been described for class IIa bacteriocins, which use the mannose permease of the phosphotransferase system (PTS) as a docking receptor on the target bacterium. In *L. monocytogenes* mutants resistant to class IIa bacteriocins, the mannose–PTS permease was not present due to decreased expression of the *mptACD* operon (Gravesen *et al.*, 2000, 2002; Vadyvaloo *et al.*, 2004b). Transcription of this operon is regulated by both sigma factor 54 (σ^{54}) and the ManR activator (Dalet *et al.*, 2001); mutations in both have been shown to result in class IIa bacteriocin resistance (Robichon *et al.*, 1997; Dalet *et al.*, 2001). In addition, an increased expression of the β -glucoside-PTS was observed in *L. monocytogenes* mutants resistant to class IIa bacteriocins (Gravesen *et al.*, 2000). The increased expression of the β -glucoside-PTS is believed to be a result of the decreased expression of the mannose–PTS, which has been reported to regulate expression of other PTS as part of catabolite repression in other Gram-positive bacteria (Chaillou *et al.*, 2001). It has been proposed that a general mechanism which results in the altered expression patterns for these two PTS is required for the class IIa bacteriocin resistance in *L. monocytogenes* (Gravesen *et al.*, 2002).

As studies continue on the potential industrial and medicinal applications of bacteriocins it is expected that novel resistance mechanisms will be identified. However, it has been proposed that the risk of resistance can be lessened by using strategies where these antimicrobial peptides would serve as one of several factors or ‘hurdles’ used in tandem to prevent the growth pathogenic and spoilage microorganisms. With regard to food preservation, this strategy has been termed ‘hurdle technology’. It offers the potential for using lower intensities of the individual components, while relying on their synergistic effects to inhibit the growth of undesirable microorganisms (Leistner and Gorris, 1995).

10.4 Bacteriocins as Components of Hurdle Technology

10.4.1 Combined with Conventional Treatments

The hurdle effect has been understood for centuries and used to prevent the outgrowth of spoilage and pathogenic microorganisms in foods. For example, high temperature, short time pasteurization cannot eliminate all contaminating microorganisms from raw milk, thus the product is subsequently stored under refrigerated conditions to extend its shelf life. Alternatively, UHT pasteurization results in a product that can be stored at room temperature for months, but also has been described as having an off-flavour due to the intensity of heat used. For this reason, many consumers prefer the two-hurdle method of milk preservation, which results in an acceptable shelf life while maintaining the expected organoleptic qualities. This concept of using multiple, mild-intensity measures to prevent the growth of undesirable microorganisms while maintaining the sensory and nutritional qualities of food is the basis of ‘hurdle technology.’ Essential to this process is an understanding of microbial homeostasis, which

is defined as the microorganism's attempt to maintain a stable and uniform internal environment (Leistner and Gorris, 1995). When the external environment changes the microorganisms must adapt to survive, thus by understanding how the microorganism responds to these stresses, essential homeostatic mechanisms can be identified as potential targets to prevent survival. Some examples of systems targeted include: cell membrane structure, DNA replication, enzymatic activities, protein synthesis, pH regulation and redox potential (Eh). The targeting of multiple systems allows for the use of lower intensity treatments, since it is unlikely that microorganisms will be able to overcome all of the hurdles applied.

Once potential hurdles are identified it is crucial to test how microorganisms will respond to various combinations, since the potential for stress-induced cross-tolerance is possible (Leistner, 2000). Microorganisms exposed to stresses, such as heat, starvation, oxidative compounds, pH changes and so on, have been shown to respond by expressing general stress shock proteins that protect against the immediate threat and increase tolerance to subsequent stresses. For example, in *L. monocytogenes* it has been reported that there is heat and acid cross-tolerance after prior exposure to various sublethal stresses (Skandamis *et al.*, 2008), and that an alternative sigma factor (σ factor) regulates alkaline-induced cross-tolerance to ethanol and osmotic stress (Giotis *et al.*, 2008). Another phenomenon associated with use of hurdle technology is metabolic exhaustion and a resulting autosterilization of food (Leistner, 2000). It has been reported that when vegetative cells are exposed to multiple hurdles they will expend all their energy attempting to maintain homeostasis, thus becoming metabolically exhausted and eventually die. The key to this effect is maintaining the cells in a vegetative state, thus storage of foods under conditions which suppress growth such as refrigeration would hinder this effect. For example, it was reported that salmonella which survived the ripening process in fermented sausage died more rapidly at ambient temperature and survived longer when the sausage was refrigerated (Leistner, 1995).

In light of the above considerations, successful implementation of hurdle technology requires an understanding of how microorganisms survive in specific food environments, what homeostatic systems to target and how the microorganism will respond to applied individual and combined stresses (hurdles). A thorough understanding of all these factors allows for development of an intelligent mixture of low intensity hurdles to control the indigenous microbial population without affecting the quality or nutritional value of the food product. Salami-type fermented sausages, which can be stored for extended periods of time at ambient temperatures, are a good example of the successful application of hurdle technology. During production the meat batter is initially treated with salt and nitrite to inhibit indigenous microorganisms, and those that survive this hurdle multiply causing a reduction in available oxygen and a drop in redox potential. These conditions favor the growth of lactic fermentation bacteria, which protect against contamination by lowering the pH of the sausage. During periods of extended ripening the sausage dries out, resulting in a lower water activity (a_w), which serves as the main hurdle during storage (Leistner and Gorris, 1995). Similar technologies are used in the production of cheese and other fermented dairy products that rely on the presence of lactic fermentation bacteria as one of several hurdles for preservation.

Currently over 60 potential hurdles have been reported in the literature (Leistner, 1999) and the search for novel hurdles continues as more emphasis is placed on the use of this technology for food preservation. The development of new hurdle technologies

continues to rely on traditional hurdles, such as temperature (high or low), water activity, redox potential, pH and preservatives (nitrite, salt), but also looks to incorporate additional hurdles, such as pulsed electric fields, modified atmosphere packaging, high hydrostatic pressure and ultrasound treatments. Lactic acid bacteria have long been used as components of hurdle technologies due to their ability to rapidly drop the pH in fermented foods and competitively inhibit the growth of other microorganism, which, in part, is due to their production of broad spectrum bacteriocins. Although success has been reported for preventing microbial contamination of foods with both bacteriocin producing cultures and their purified peptides alone, recent studies have shown that their potential as food preservatives increases when they are used in conjunction with other hurdles. Successful applications of bacteriocins in hurdle technology have been summarized in several reviews (Chen and Hoover, 2003; Galvez *et al.*, 2007a; Mills *et al.*, 2011b), reporting both additive and synergistic effects for controlling the growth of food-borne pathogens and demonstrating the potential for broadening the antimicrobial spectrum of these peptides.

When organic acids and their salt derivatives were included as hurdles, the resulting drop in pH was reported to increase bacteriocin solubility and overall net charge, which favoured translocation of the peptide through the target bacterium's cell wall (Galvez *et al.*, 2007a). The inclusion of these natural preservatives was shown to enhance the activity of several bacteriocins including: nisin (Buncic *et al.*, 1995; Avery and Buncic, 1997; Nykanen *et al.*, 2000), lactacin 3147 (Scannell *et al.*, 2000), enterocin AS-48 (Grande *et al.*, 2006) and pediocin (Schlyter *et al.*, 1993; Uhart *et al.*, 2004). Other natural preservatives that were reported to have a synergistic effect with LAB bacteriocins were ethanol (Brewer *et al.*, 2002), sucrose fatty acid esters (Thomas *et al.*, 1998), nitrite (Taylor *et al.*, 1985; Gill and Holley, 2003), phenolic compounds from essential oils, such as carvacol, eugenol and thymol (Pol and Smid, 1999; Periago *et al.*, 2001; Yamazaki *et al.*, 2004), and carbon dioxide through modified atmosphere packaging (Nilsson *et al.*, 2000). It was also reported that the presence of LAB bacteriocins allowed for lower concentrations of nitrite and phenolic compounds to be used, thus enhancing the overall quality of the food. Although bacteriocins were successfully used in conjunction with several natural preservatives, results using sodium chloride as an additional hurdle were not consistent. In some studies, sodium chloride was reported to enhance the activity of bacteriocins, such as nisin (Thomas and Wimpenny, 1996) and enterocin AS-48 (Ananou *et al.*, 2004); however, other studies reported that NaCl inhibited the antilisterial activity of other bacteriocins, such as pediocin (Jydegaard *et al.*, 2000) and acidocin CH5 (Chumchalova *et al.*, 1998). It was also reported that low concentrations of NaCl could inhibit nisin activity (Bouttefroy *et al.*, 2000). It was suggested that this antagonistic effect is due to interference with the ionic interactions required for bacteriocin binding to the target cell (Bhunja *et al.*, 1991), which could be the result of NaCl-induced conformation changes in the peptide structure (Lee *et al.*, 1993) or within the cell envelope of the targeted bacterium (Jydegaard *et al.*, 2000).

When used in combination with heat treatments, bacteriocins have been shown to enhance thermal inactivation, thus requiring lower intensities and shorter treatment times. Nisin and heat have been shown to function synergistically, resulting in a 35% reduction in the pasteurization time for liquid whole egg or egg white (Boziaris *et al.*, 1998) and reduced heat resistance of *L. monocytogenes* in milk (Maisnier-Patin *et al.*, 1995) and cold-packed lobster meat (Budu-Amoako *et al.*, 1999). The combination of these hurdles was also shown to sensitize nisin-resistant mutants of *L. monocytogenes*

to thermal inactivation at 55°C (Modi *et al.*, 2000), demonstrating that cross-resistance did not occur. In studies with enterocin AS-48, heat treatments were shown to sensitize *S. aureus* to bacteriocin activity (Ananou *et al.*, 2004), and the presence of this bacteriocin was reported to lower the intensity of heat treatments required for inactivation of bacterial endospores (Beard *et al.*, 1999; Wandling *et al.*, 1999; Grande *et al.*, 2006).

10.4.2 Combined with Emerging Technologies

Successful applications have been reported for bacteriocins used with various nonthermal hurdles including high hydrostatic pressure (HHP), pulsed electric fields (PEF) and irradiation. HHP treatment disrupts hydrogen bonds, ionic bonds and hydrophobic interactions, which results in sublethal damage to the bacterial cell membrane that affects the function of ATP-generating and transport proteins (Hoover, 1993; Kato and Hayashi, 1999). Several studies have investigated the combinatorial effects of bacteriocins and HHP technology. For example, both nisin (Farkas *et al.*, 2003) and pediocin (Kalchayanand *et al.*, 1998) have been shown to have synergistic effects when applied with HHP on cultures of *L. monocytogenes* and other food-borne pathogens, and the combination of both bacteriocins were shown to kill *Clostridium* spores that were induced to germinate by treatment with HHP (Kalchayanand *et al.*, 2004). Pulsed electric field technology also acts by damaging bacterial cell membranes by the application of high-voltage pulses between a set of electrodes (Vega-Mercado *et al.*, 1997). This technology is limited to foods that can be pumped between the set of electrodes, but several studies have looked at the potential for combining this process with bacteriocins to increase its effectiveness. Depending on the PEF conditions used, both additive and synergistic effects were reported when combined with nisin for inhibiting the growth of *L. innocua* in liquid eggs and skimmed milk (Calderon-Miranda *et al.*, 1999a, 1999b). In conjunction with irradiation technologies, pediocin was reported to increase the antimicrobial effect on *L. monocytogenes* in frankfurters (Chen *et al.*, 2004) and the combined use of nisin (80 IU/ g beans) and irradiation (5 kGy) on sous-vide (90°C, 10 min) smoked-cured pork with boiled beans resulted in a greater than 5 log₁₀ reduction in *B. cereus* when compared to the use of heat alone (Farkas *et al.*, 2002). The inclusion of nisin was essential to suppress the growth of *B. cereus* in pork stored for greater than 28 days at 10°C.

A major limitation for the use of bacteriocins from lactic acid bacteria as natural food preservative is their general lack of activity against Gram-negative bacteria, such as *E. coli*, *Salmonella* and *Pseudomonas* species. However, when used in combination with other hurdles their spectrum of activity has broadened to include Gram-negative bacteria. For example, chelating agents such as EDTA have been shown to permeate the Gram-negative outer membrane by extracting Mg²⁺ cations, which stabilize the lipopolysaccharide structure. By destabilizing the outer membrane these bacteriocins gain access to the Gram-negative cell membrane, which is susceptible to their pore forming activity (Schved *et al.*, 1994; Herlander *et al.*, 1997). In addition to chelating agents, other hurdles such as heat (Kalchayanand *et al.*, 1992; Boziaris *et al.*, 1998), PEF (Terebiznik *et al.*, 2000; Liang *et al.*, 2002; Santi *et al.*, 2003) and HHP (Hauben *et al.*, 1996; Masschalck *et al.*, 2001), which act to disrupt the bacterial cell membrane, have also been shown to extend the spectrum of bacteriocin activity to Gram-negative bacteria.

10.5 Bacteriocins in Hurdle Technology for Dairy Food Safety

Hurdle technologies are essential in the preservation of dairy products. Commonly used hurdles include HTST or UHT pasteurization, refrigeration, salting, reduction in pH due to LAB fermentation and a decreased water activity. More recently, other processing methods such as PEF and HHP have also been investigated for their potential in the preservation of various dairy products. The application of bacteriocins alone or in combination with other hurdles was the topic of a review (Sobrino-Lopez and Martin-Belloso, 2008b) but studies are ongoing to optimize their potential in dairy hurdle technologies. Table 10.2 presents examples of recent studies aimed at incorporating bacteriocins as components of hurdle technologies for the preservation of several dairy products. Nisin continues to be the focus of most studies, since it is the only purified bacteriocin fully approved for use in foods. Although its inhibitory activity has been demonstrated within dairy foods, its efficacy in the presence of additional hurdles is still being investigated since previous studies have shown a decrease in potency when used with other preservatives, such as NaCl (Bouttefroy *et al.*, 2000).

10.5.1 Bacteriocins Combined with Temperature Regulation

The presence of nisin has been shown to reduce the intensity of heat treatments required for destruction of food-borne pathogens in milk. The addition of nisin at 25 or 50 IU/ml was shown to lower the intensity of heat treatment required for a 3–6 \log_{10} reduction of *L. monocytogenes* in cheese milk (Maisnier-Patin *et al.*, 1995). A 3 \log_{10} reduction of *L. monocytogenes* was achieved in 16 minutes when milk containing 25 IU/ml of nisin was heated to 54°C, which was an 80% reduction in time compared to the 77 minutes required in the absence of nisin. In addition, the presence of nisin was also reported to reduce the heat resistance phenotype of *L. monocytogenes* when stored at 4°C prior to heat treatment. It was suggested that the observed synergistic effect would result in a lower production cost and an improved product with a more traditional, raw-milk quality due to the lower thermal intensity required. More recently, another study reported a synergistic effect with heat (63°C, 5 min) and nisin (1000 or 1500 IU/ml) in cheese curd inoculated with *L. innocua* and subsequently stored at 4 or 10°C (Al-Holy *et al.*, 2012). The reduction of *L. innocua* occurred more rapidly when the cheese was stored at 10°C but after 12 days of storage *L. innocua* could not be recovered from cheese stored at 4 or 10°C. *L. monocytogenes* was eliminated from fully ripened Greek Graviera cheese due to the presence of multiple bacteriocin-producing lactic acid bacteria and storage for 60 days at 25°C (Giannou *et al.*, 2009). When stored at lower temperatures (4 or 12°C) the bacteriocin-producing cultures prevented the growth of listeria but long-term survival (>60 days) of the pathogen was observed. These results demonstrate the need to optimize conditions for hurdle technologies to effectively eliminate bacterial contaminants.

The combination of nisin (75 IU/ml or 150 IU/ml) and a reduced heat treatment (RHT, 117°C, 2 s) was shown to result in a low spoilage rate for milk stored at 30°C for 150 days, while 90% of the RHT-milk samples showed signs of spoilage after two weeks. Furthermore, RHT-nisin milk stored at 10 or 20°C had no detectable microbial activity for up to one year of storage. Sensory evaluation also showed a preference for

Table 10.2 Studies investigating the potential for using bacteriocins as a component of hurdle technology in dairy products

Bacteriocin	Additional Hurdles	Target Microorganism	Dairy Product	References
Gassericin A (49 AU/ ml)	Glycine (0.5%)	<i>B. cereus</i> <i>L. lactis</i> ssp. <i>lactis</i> <i>Achromobacter</i> <i>denitrificans</i> <i>P. fluorescens</i>	Custard cream	Arakawa <i>et al.</i> , 2009; Nakamura <i>et al.</i> , 2013
Nisin (1000 or 1500 IU/ ml)	Temperature (63°C)	<i>L. innocua</i>	White cheese	Al-Holy <i>et al.</i> , 2012
Nisin (328 IU/ml)	High pressure (654 MPa) Heat (74°C)	<i>C. perfringens</i> spores	UHT Milk	Gao <i>et al.</i> , 2011
Nisin (400 IU/ml)	Thymol (0.08 mg/ml)	<i>L. monocytogenes</i>	UHT milk	Xiao <i>et al.</i> , 2011
Nisin (250 IU/ ml)	Poly(lactic acid (1 g) Temperature (4 or 10°C)	<i>L. monocytogenes</i>	Skimmed milk Liquid egg	Jin, 2010
Nisin (0.75 µg/ ml)	Endolysin LysH5 (15 U/ ml)	<i>S. aureus</i>	Milk	Garcia <i>et al.</i> , 2010a
Nisin (50 IU/ ml)	Lactic acid, Malic acid, Citric acid (1.5 or 3.0%)	<i>L. monocytogenes</i>	Whey protein-based film (for use as cheese wrap)	Pintado and Ferreira, 2009
Nisin (20 IU/ ml) Enterocin AS-48 (28 AU/ml)	High intensity pulsed electric field (HIPEF, 800 µs)	<i>S. aureus</i>	Milk	Sobrino-Lopez <i>et al.</i> , 2009
Enterocin A (adjunct culture used in cheese making)	Temperature (4, 12 or 25°C)	<i>L. monocytogenes</i>	Greek Graviera cheese	Giannou <i>et al.</i> , 2009

Nisin (500 IU/ml)	High pressure (500 MPa)	<i>B. subtilis</i> <i>B. cereus</i> spores	Reconstituted skimme milk	Black <i>et al.</i> , 2008
Nisin (0.0025µM)	αS2-casein f(183-207) (0.0025µM)	<i>L. monocytogenes</i>	Tested in Brain Heart Infusion Agar (BHIA)	Lopez-Exposito <i>et al.</i> , 2008
Nisin (300 IU/ ml)	HIPEF (1200 µs)	<i>S. aureus</i>	Milk	Sobriño-Lopez and Martin-Belloso, 2008a
Nisin (100 IU/ ml)	Reuterin (2 AU/ml) Lactoperoxidase (0.2 AB-TSU/ ml)	<i>L. monocytogenes</i> <i>S. aureus</i>	Cuajada (curdled milk)	Arques <i>et al.</i> , 2008
Nisin (100 IU/ ml)	Microgard™ (5%)	<i>L. innocua</i>	Liquid cheese whey	von Staszewski and Jagus, 2008
Nisin, lacticin 481, bacteriocin TAB57, Enterocin AS-48, Enterocin I	High pressure (300 or 500 MPa)	<i>E. coli</i> O157:H7 <i>S. aureus</i>	Raw-milk cheese Raw milk cheese	Rodriguez <i>et al.</i> , 2005 Arques <i>et al.</i> , 2005
Nisin (1.56 mg/ ml)	High hydrostatic pressure (400 MPa)	<i>B. cereus</i>	Raw-milk cheese	Lopez-Pedemonte <i>et al.</i> , 2003
Nisin (1200 IU/ ml)	Pulsed electric field (PEF, 5 kV/cm) Water activity (0.95)	<i>E. coli</i>	Simulated milk ultrafiltrate media	Terebiznik <i>et al.</i> , 2002
Nisin (0.04 µg/ml)	PEF (16.7 kV/cm) Carvacrol (1.2 mM)	<i>B. cereus</i>	Milk	Pol <i>et al.</i> , 2001

(continued overleaf)

Table 10.2 (continued)

Bacteriocin	Additional Hurdles	Target Microorganism	Dairy Product	References
Nisin (75 and 150 IU/ml)	Heat treatment (117°C, 2 s)	Spore-forming bacteria (Bacilli)	Milk	Wirjantoro <i>et al.</i> , 2001
Lacticin 3147 (10 000 or 15 000 AU/ml)	HHP (150, 275, 400 or 800 MPa)	<i>S. aureus</i> <i>L. innocua</i>	Milk and whey	Morgan <i>et al.</i> , 2000
Nisin (100 or 200 IU/ml)	Lactoperoxidase	<i>L. monocytogenes</i>	Skimmed milk	Boussouel <i>et al.</i> , 2000
Nisin (10 or 100 IU/ml)	PEF (30, 40, 50 kV/cm)	<i>L. innocua</i>	Skimmed milk	Calderon-Miranda <i>et al.</i> , 1999b
Nisin (2000 or 4000 IU/ml)	Heat (97, 100, 103 and 130°C)	<i>B. cereus</i> <i>Bacillus stearothermophilus</i>	Skimmed milk	Wandling <i>et al.</i> , 1999
Nisin (10 or 100 IU/ml)	Lactoperoxidase (0.2 or 0.8 ABTSU/ml)	<i>L. monocytogenes</i>	UHT Skimmed milk	Zapico <i>et al.</i> , 1998
Nisin (2.5 mg/ml)	Acetic acid, Sorbate	<i>L. monocytogenes</i>	Ricotta cheese	Davies <i>et al.</i> , 1997

the RHT-nisin milk over UHT milk (Wirjantoro *et al.*, 2001). Spore control in milk was also enhanced due to the synergistic effect of nisin (4000 IU/ml) and heat treatment (Wandling *et al.*, 1999). The combination of nisin and heat (103°C) reduced the time required to kill 90% of *B. cereus* spores by 42% in milk. Similarly, the time needed to kill *B. stearothermophilus* spores was reduced by 21% when heat treatment was increased to 130°C.

10.5.2 Bacteriocins Combined with Other Natural Preservatives

In raw milk the lactoperoxidase–thiocyanate–hydrogen peroxide system (LPS) occurs naturally and protects against bacterial contamination through the production of hypothiocyanite ions, which were reported to have bactericidal activity against Gram-negative bacteria (Beumer *et al.*, 1985; Wolfson and Sumner, 1994) and bacteriostatic activity against Gram-positive bacteria (Kamau *et al.*, 1990). LPS activity can be tested in UHT milk by the addition of purified bovine lactoperoxidase, sodium thiocyanate and hydrogen peroxide; and was reported to have a synergistic effect when combined with nisin (Zapico *et al.*, 1998). The combined effect was reported to be bactericidal against *L. monocytogenes* and possibly due to both hurdles targeting the cytoplasmic membrane. Interestingly their combined effect was improved when application of the hurdles was staggered. When they were applied simultaneously at the time of inoculation, a 5.6 log reduction of *L. monocytogenes* was observed; however, when nisin was applied two hours and LPS was applied five hours after inoculation, a 7.4 log reduction was observed (Zapico *et al.*, 1998). Other studies showed that the combinatorial effect of these two hurdles was not dependent on the environmental pH (Boussouel *et al.*, 1999) and that a combination of LPS, nisin and reuterin, an antimicrobial compound produced by *Lactobacillus reuteri*, could inhibit the growth of *Staphylococcus aureus*, which was resistant to hurdle technology using only LPS and nisin in Cuajadán, a Spanish semisolid dairy product (Arques *et al.*, 2008).

Both organic acids and essential oils have been shown to be effective antimicrobial agents. However, when used at high concentrations they can impart off-flavours to foods. Monolaurin, the monoester of lauric acid, has been shown to have antimicrobial properties (Wang and Johnson, 1997), but it can also result in dairy products with a soapy odour and taste (Bell and del Lacy, 1987). To lower its effective concentration it has been tested in combination with nisin to serve as a dairy preservative. The simultaneous addition of nisin and monolaurin was reported to inhibit the growth of *Bacillus licheniformis* (Mansour *et al.*, 1999), and in another study showed bactericidal activity against several *Bacillus* species, preventing both sporulation or regrowth in skimmed milk (Mansour and Milliere, 2001). Nisin was also reported to control the growth of *L. monocytogenes* in a raw-milk ricotta-type cheese prepared by direct acidification with acetic acid. It was reported that unsafe levels of *L. monocytogenes* were reached within 1–2 weeks of storage without nisin but inclusion of the bacteriocin controlled the growth of *Listeria* for over 10 weeks when stored at 6–8°C (Davies *et al.*, 1997).

The potential for combining nisin and organic acids for the production of antimicrobial films and coatings has also been studied. Whey protein isolate and glycerol were combined to form an edible film that could be designed to include antimicrobial agents to serve as a protective coating for cheese. The film pH was decreased by the inclusion of lactic, malic or citric acid; nisin (50 IU/ml) was included as an additional hurdle to

prevent the growth of *L. monocytogenes*. The inclusion of nisin was reported to alter the film viscosity when lactic or citric acid was present but films containing malic acid were not affected. The combination of malic acid and nisin also showed the highest antilisterial activity; thus it was included that this hurdle combination has the potential to produce an effective antimicrobial film (Pintado and Ferreira, 2009). The potential for developing an antimicrobial bottle coating for use with skimmed or liquid egg was investigated by creating a polylactic acid (PLA) polymer containing various concentrations of nisin. In bottles coated with PLA and 250 mg nisin, the initial inoculum of *L. monocytogenes* (about 1×10^4) was reduced to undetectable levels in skimmed milk by three days and remained undetectable for the 42 day storage period at either 4 or 10°C (Jin, 2010). A combination of thymol and nisin was also reported to inhibit the growth of *L. monocytogenes* in 2% reduced fat milk at 25°C (Xiao *et al.*, 2011). In this study it was reported that inclusion of the antimicrobial hurdles in spray-dried zein capsules that allowed for a sustained release of both agents was more effective than the use of free antimicrobials. These results suggest that encapsulated delivery systems may offer advantages to the use of hurdle technologies in dairy foods.

The potential for combining nisin and milk-derived peptides or proteins, with reported antimicrobial properties, has shown some promise for inhibiting the growth of microbial contaminants. A 25-mer peptide derived from α s2-casein (f(183-207) was reported to synergistically enhance the activity of nisin against both *Staphylococcus epidermidis* and *L. monocytogenes*, possibly by destabilizing the target bacterium's membrane (Lopez-Exposito *et al.*, 2008). However, when nisin was used in combination with α s2-casein f(183-207) or bovine lactoferricin f(17-41), the individual hurdles were antagonistic to one another with regard to their *E. coli* activities. These results emphasize the need to test multiple targets when developing potential hurdle strategies that will affect several microorganisms within the targeted food product.

Limited studies have investigated the potential for combining nisin with other microbial factors in the development of novel hurdle technologies for preservation of dairy foods. When combined with lysozyme in cheese milk an inhibitory effect was reported for several strains of lactobacilli but the combination was not tested for its effect against potential pathogens (Kozakova *et al.*, 2005). Synergistic effects were reported when nisin was combined with the cell-free supernatant of *Bacillus licheniformis* ZJU12 to inhibit the growth of *Micrococcus flavus*, *B. cereus* and *S. aureus* (He and Chen, 2006), and with phage endolysin LysH5 for inhibition of *S. aureus* (Garcia *et al.*, 2010a). When combined, the minimum inhibitory concentrations for nisin and LysH5 were lowered by 64- and 16-fold, and it was reported that complete clearance of *S. aureus* Sa9 from milk required the presence of both antimicrobials. Conflicting results were obtained when nisin was combined with Microgard™, which is defined as a bacteriocin-like inhibitory product obtained by the fermentation of skim milk or dextrose with *Propionibacterium shermanii* or specific *Lactococci*. These fermentates have been reported to display antimicrobial activity against spoilage and pathogenic bacteria in dairy foods; however, when combined with nisin and an additional hurdle, for example storage at low temperatures, 7°C, an antagonistic effect was observed against *Listeria innocua* in liquid cheese whey. If the additional stress was not present it was reported that nisin could enhance the antilisterial activity of Microgard™, making this combination a potential strategy for extending the shelf life of cheese whey (von Staszewski and Jagus, 2008).

The potential for using multiple bacteriocins has been studied extensively *in vitro* to test for possible cross-resistance patterns; however, direct applications within dairy

foods are still lacking. One study looked at the potential for combining nisin with pediocin 34 and/or enterocin FH99 for controlling the growth of *L. monocytogenes* (Kaur *et al.*, 2013). The study reported that any combination of two, or the presence of all three bacteriocins, resulted in a higher antibacterial activity. Cross-resistance was observed for bacteriocins within the same class, as pediocin resistant *Listeria* were also more resistant to enterocin FH99, but cross-resistance with nisin was not observed. It was also noted that bacteriocin resistance did not confer cross-resistance to other intrinsic hurdles such as low pH, sodium chloride, potassium sorbate or sodium nitrite. These results suggest there is a potential for using multiple bacteriocins in food preservation but more detailed studies are required for dairy food applications. Two studies have investigated the potential for using a novel bacteriocin isolated from *Lactobacillus gasseri*, gassericin A, in combination with the amino acid glycine for the preservation of custard creams (Arakawa *et al.*, 2009; Nakamura *et al.*, 2013). It was reported that the combination of glycine (0.5%) and gassericin A (123 AU) was able to prevent the growth of *Bacillus cereus* and *Lactococcus lactis* ssp. *lactis* within the custard cream, and that in the absence of glycine both bacterial species were able to overcome an initial growth inhibition due to the presence of gassericin A alone. This study shows the potential for glycine as a hurdle with other bacteriocins and confirms the potential of applications of newly discovered bacteriocins.

10.5.3 Bacteriocins and Pulsed Electric Fields

High intensity PEF (HIPEF) results in changes to the cell membrane structure preventing it from functioning properly as a semipermeable barrier. Transmission electron microscopy of *L. innocua* treated with electric field intensities between 30 and 50 kV/cm in skimmed milk showed an increase in cell wall roughness, cytoplasmic clumping, leakage of cellular material and rupture of both cell walls and membranes (Calderon-Miranda *et al.*, 1999c). When combined with 37 IU/ml nisin, an additive effect on the morphological damage to the cell wall and membrane was observed, and at intensities at or above 40 kV/cm pore formation was observed. This additive effect was shown to reduce the number of *L. innocua* by 3.8 log units after an initial exposure to PEF (50 kV/cm) and subsequent treatment with nisin at 37 IU/ml (Calderon-Miranda *et al.*, 1999b). However, in a separate study, pretreatment of *E. coli* with HIPEF resulted in a decrease in nisin activity. It was proposed that the reduced nisin activity may be due to nonspecific binding of the bacteriocin to cellular debris released by the PEF pretreatment (Terebiznik *et al.*, 2002). Nisin activity was restored and improved by reducing the water activity to 0.95. A synergistic effect resulting in a 5 log cycle reduction of *E. coli* was reported when water activity was reduced to 0.95 and combined with low intensity PEF (5 kV/cm) and subsequent nisin treatment at 1200 IU/ml. Other studies have also reported that the order of treatments results in different effects, with a synergistic effect for HIPEF and nisin being observed when nisin was applied first (Gallo *et al.*, 2007). The contradictory results reported from these studies suggest further studies are required to optimize the potential for this hurdle technology.

Additional studies have reported success when combining HIPEF and nisin treatments with a third hurdle. The addition of 1.2 mM carvacrol was reported to enhance the synergistic effect of PEF (16.7 kV/cm) and nisin (0.04 µg/ml) against *B. cereus* grown in milk (Pol *et al.*, 2001). It was also reported that the presence of milk proteins did not influence the activity, as similar results were obtained in the

presence of 5 or 20% milk proteins. Applying HIPEF (35 kV/cm) to milk containing 1 IU/ml nisin and 300 IU/ml lysozyme resulted in a 6.2 log reduction of *S. aureus* (Sobrinio-Lopez and Martin-Belloso, 2008a). A similar reduction in the number of *S. aureus* in milk was reported when nisin (20 IU/ml) was used in combination with enterocin AS-48 (28 AU/ml), followed by subsequent treatment with HIPEF (35 kV/cm) (Sobrinio-Lopez *et al.*, 2009). Both of these strategies were reported to depend on the order of applications, thus it was suggested that further optimization of these systems was required for successful application in dairy foods.

10.5.4 Bacteriocins and High-Pressure Processing

Hurdle technologies involving the use of nisin and HHP have been reported to result in a synergistic antimicrobial effect on both Gram-positive and Gram-negative bacteria. It was hypothesized that this synergism may be due to either the binding of nisin to the cell membrane, which immobilizes membrane phospholipids and increases the microorganisms sensitization to pressure treatments (Ter Steeg *et al.*, 1999), or a result of the sublethal permeabilization of the cell wall or outer membrane making the microorganism more sensitive to the effects of nisin (Hauben *et al.*, 1996). The synergistic effect of combining HHP (500 MPa, 5 min) and nisin (500 IU/ml) was shown to completely inactivate *Pseudomonas fluorescens* and *E. coli* in milk and reduce the number of *L. innocua* by 8.3 log (Black *et al.*, 2005). The addition of nisin (400 IU/ml) or lysozyme (400 µg/ml) prior to HHP treatment (550 MPa) was reported to reduce the number of pressure-resistant *E. coli* in skimmed milk by 3 log units, but the reduction level was significantly less in the whole milk (Garcia-Graells *et al.*, 1999). When pediocin PA-1 was used in combination with nisin and HHP treatment (345 MPa), an 8 log reduction in *S. aureus* was achieved in milk and no growth was observed during a 30 day storage period at 25°C (Alpas and Bozoglu, 2000). The potential for using other bacteriocins in combination with HHP was investigated and lacticin 3147 was reported to have an additive effect with HHP (250 MPa) in whey and milk (Morgan *et al.*, 2000). The combination of lacticin 3147 and HHP reduced the number of *L. innocua* DPC1770 by 6 log units; bacteriocin activity was reported to increase with an increase in pressure to 400 MPa.

HHP treatment was evaluated for its ability to control bacterial contamination in raw milk cheeses produced with bacteriocin-producing starter or adjunct cultures. The incorporation of LAB producing either lacticin-481, nisin A, bacteriocin TAB57, enterocin I or enterocin AS-48, in combination with HHP (300 MPa) treatment on day 2 of storage, were shown to reduce the level of *E. coli* O157:H7 (inoculated at about 10⁵ CFU/ml) to below 2 log units in a 60 day old cheese. If HHP was applied on day 50 the level of *E. coli* was undetectable on day 60 (Rodriguez *et al.*, 2005). A synergistic effect with bacteriocin-producing LAB and HHP treatment was also reported for the growth of *S. aureus* in raw milk cheese (Arques *et al.*, 2005). An optimal reduction of 4 log units was reported for a three day old cheese that was treated with HHP at 500 MPa on day 2 of storage. These results suggest that HHP may be an effective preservation method for raw milk cheeses produced with adjunct cultures known to produce bacteriocins.

The combination of nisin and HHP was tested for its effect on germination and inactivation of both *Bacillus* and *Clostridial* spores in milk and cheese. A 2.4 log reduction in *B. cereus* ATCC 9139 spores was reported in model cheeses containing 1.56 mg/ml nisin and treated twice with HHP cycles at 400 MPa at 30°C for 15 minutes

(Lopez-Pedemonte *et al.*, 2003). The use of lysozyme (22.4 mg/l) in place of nisin did not enhance HHP-induced spore inactivation, demonstrating that nisin was essential for the observed results. Another study reported a 5.9 log reduction of *B. subtilis* in milk containing 500 IU/ml nisin and undergoing two cycles of HHP treatment at 500 MPa. The same process resulted in a 3–4 log inactivation and a 5–8 log germination of *B. cereus* spores in milk, depending on the specific strain being tested (Black *et al.*, 2008). Inactivation of *Clostridium perfringens* spores required the use of 645 MPa pressure, a temperature of 74°C, a holding time of 13.6 minutes and a nisin concentration of 328 IU/ml; it resulted in a 6 log cycle reduction of spores (Gao *et al.*, 2011). Although the conditions are more stringent than what is required for inactivation of vegetative cells, these reports demonstrate the potential for using HHP in combination with LAB bacteriocins for the inactivation of spores in dairy products.

10.6 Conclusions

Numerous studies have demonstrated the efficacy of LAB bacteriocins for controlling the growth of undesirable microorganisms in fluid milk and other dairy products. These studies have shown that bacteriocins have the potential to serve as sole preservatives. However, several studies have shown that their incorporation as components of hurdle technologies offers significant advantages including: lower intensity treatments, synergistic and additive antimicrobial activities and a broadening of their antimicrobial spectrum. Although their success in hurdle technologies is well documented, there is still a need for further investigation as many studies are carried out in laboratory models and must be tested within actual products to ensure that the effect is not impeded by the food environment, and to ensure that the treatments do not inhibit the growth of essential microorganisms (e.g. starter or adjunct cultures) or impart undesirable qualities on the food.

The potential of these antimicrobials is expected to grow with continuing developments in molecular biology. With an increasing number of bacterial genomes being completed it is reasonable to believe that novel antimicrobial peptides will be discovered, as will the mechanisms regulating production within their bacterial hosts. Through the use of biotechnology these findings will allow for the development of new ways to produce and incorporate these peptides as natural food preservatives. Examples of the successful implementation of biotechnologies include: the development of novel dairy starter and adjunct cultures that have been engineered to produce bacteriocins (Coderre and Somkuti, 1999; Somkuti and Steinberg, 2003); the development of LAB cultures capable of producing multiple bacteriocins (O’Sullivan *et al.*, 2003b); the use of inducible expression systems for increasing the production of bacteriocins (Renyé and Somkuti 2010); and the development of potential food-grade gene delivery systems (Renyé and Somkuti, 2009). Additionally, advances in biotechnology may identify ways of increasing the production of bacteriocins from natural and recombinant hosts, thus potentially lowering their production cost. It has been reported that the cost of producing nisin and other peptide antimicrobials continues to limit their use as effective components of hurdle technologies for food preservation (Jones *et al.*, 2005). Thus, although their potential as natural food preservative is well understood, studies are continuing to optimize their production, improve their effectiveness in food matrices and identify ideal hurdle combinations that will maximize their activity.

References

- Abachin, E., Poyart, C., Pellegrini, E. *et al.* (2002) Formation of D-alanyl-lipoteichoic acid is required for adhesion and virulence of *Listeria monocytogenes*, *Molecular Microbiology* **43**: 1–14.
- Abbasiliasi, S., Tan, J. S., Ibrahim, T. A. *et al.* (2012) Isolation of *Pediococcus acidilactici* Kp10 with ability to secrete bacteriocin-like inhibitory substance from milk products for applications in food industry, *BMC Microbiology* **12**: 260.
- Abi Khattar, Z., Rejasse, A., Destoumieux-Garzon, D. *et al.* (2009) The *dlt* operon of *Bacillus cereus* is required for resistance to cationic antimicrobial peptides and for virulence in insects, *Journal of Bacteriology* **191**: 7063–7073.
- Achemchem, F., Abrini, J., Martinez-Bueno, M. *et al.* (2006) Control of *Listeria monocytogenes* in goat's milk and goat's jben by the bacteriocinogenic *Enterococcus faecium* F58 strain, *Journal of Food Protection* **69**: 2370–2376.
- Al-Holy, M. A., Al-Nabulsi, A., Osaili, T. M. *et al.* (2012) Inactivation of *Listeria innocua* in brined white cheese by a combination of nisin and heat, *Food Control* **23**: 48–53.
- Alegria, A., Delgado, S., Roces, C. *et al.* (2010) Bacteriocins produced by wild *Lactococcus lactis* strains isolated from traditional, starter-free cheeses made of raw milk, *International Journal of Food Microbiology* **143**: 61–66.
- Alkhatib, Z., Abts, A., Mavaro, A. *et al.* (2012) Lantibiotics: how do producers become self-protected? *Journal of Biotechnology* **159**: 145–154.
- Alpas, H. and Bozoglu, F. (2000) The combined effect of high hydrostatic pressure, heat and bacteriocins on inactivation of foodborne pathogens in milk and orange juice, *World Journal of Microbiology and Biotechnology* **16**: 387–392.
- Ananou, S., Valdivia, E., Martinez Bueno, M. *et al.* (2004) Effect of combined physico-chemical preservatives on enterocin AS-48 activity against the enterotoxigenic *Staphylococcus aureus* CECT 976 strain, *Journal of Applied Microbiology* **97**: 48–56.
- Ananou, S., Munoz, A., Galvez, A. *et al.* (2008) Optimization of enterocin AS-48 production on a whey-based substrate, *International Dairy Journal* **18**: 923–927.
- Anastasiou, R., Aktypis, A., Georgalaki, M. *et al.* (2009) Inhibition of *Clostridium tyrobutyricum* by *Streptococcus macedonicus* ACA-DC 198 under conditions mimicking Kasserli cheese production and ripening, *International Dairy Journal* **19**: 330–335.
- Arakawa, K., Kawai, Y., Iioka, H. *et al.* (2009) Effects of gassericins A and T, bacteriocins produced by *Lactobacillus gasserii*, with glycine on custard cream preservation, *Journal of Dairy Science* **92**: 2365–2372.
- Arques, J. L., Rodriguez, E., Gaya, P. *et al.* (2005) Inactivation of *Staphylococcus aureus* in raw milk cheese by combinations of high-pressure treatments and bacteriocin-producing lactic acid bacteria, *Journal of Applied Microbiology* **98**: 254–260.
- Arques, J. L., Rodriguez, E., Nunez, M. and Medina, M. (2008) Antimicrobial activity of nisin, reuterin, and the lactoperoxidase system on *Listeria monocytogenes* and *Staphylococcus aureus* in cuajada, a semisolid dairy product manufactured in Spain, *Journal of Dairy Science* **91**: 70–75.
- Avery, S. M. and Buncic, S. (1997) Antilisterial effects of a sorbate-nisin combination in vitro and on packaged beef at refrigeration temperature, *Journal of Food Protection* **60**: 1075–1080.
- Aziz, T., Khan, H., Bakhtair, S. M. and Naurin, M. (2009) Incidence and relative abundance of lactic acid bacteria in raw milk of buffalo, cow and sheep, *The Journal of Animal and Plant Sciences* **19**: 168–173.

- Azuma, T., Bagenda, D. K., Yamamoto, T. *et al.* (2007) Inhibition of *Listeria monocytogenes* by freeze-dried piscicocin CS526 fermentate in food, *Letters in Applied Microbiology* **44**: 138–144.
- Batdorj, B., Dalgalarondo, M., Choiset, Y. *et al.* (2006) Purification and characterization of two bacteriocins produced by lactic acid bacteria isolated from Mongolian airag, *Journal of Applied Microbiology* **101**: 837–848.
- Beard, B. M., Sheldon, B. W. and Foegeding, P. M. (1999) Thermal resistance of bacterial spores in milk-based beverages supplemented with nisin, *Journal of Food Protection* **62**: 484–491.
- Belguesmia, Y., Choiset, Y., Rabesona, H. *et al.* (2013) Antifungal properties of durancins isolated from *Enterococcus durans* A5-11 and of its synthetic fragments, *Letters in Applied Microbiology* **56**: 237–244.
- Bell, R. G., and del Lacy, K. M. (1987) The efficacy of nisin, scorbic acid and monolaurin as preservatives in pasteurized cured meat products, *Food Microbiology* **4**: 277–287.
- Benech, R. O., Kheadr, E. E., Laridi, R. *et al.* (2002) Inhibition of *Listeria innocua* in cheddar cheese by addition of nisin Z in liposomes or by *in situ* production in mixed culture, *Applied and Environmental Microbiology* **68**: 3683–3690.
- Benkerroum, N., Oubel, H. and Mimoun, L. B. (2002) Behavior of *Listeria monocytogenes* and *Staphylococcus aureus* in yogurt fermented with a bacteriocin-producing thermophilic starter, *Journal of Food Protection* **65**: 799–805.
- Benkerroum, N., Oubel, H. and Sandine, W. E. (2003) Effect of nisin on yogurt starter, and on growth and survival of *Listeria monocytogenes* during fermentation and storage of yogurt, *Internet Journal of Food Safety* **1**: 1–5.
- Beumer, R. R., Noomen, A., Marijs, J. A. and Kampelmacher, E. H. (1985) Antibacterial action of the lactoperoxidase system on *Campylobacter jejuni* in cow's milk, *Netherlands Milk Dairy Journal* **39**: 107–114.
- Bhunia, A. K., Johnson, M. C., Ray, B. and Kalchayanand, N. (1991) Mode of action of pediocin AcH from *Pediococcus acidilactici* H on sensitive bacterial strains, *Journal of Applied Bacteriology* **70**: 25–33.
- Black, E. P., Kelly, A. L. and Fitzgerald, G. F. (2005) The combined effect of high pressure and nisin on inactivation of microorganisms in milk, *Innovative Food Science and Emerging Tehnologies* **6**: 286–292.
- Black, E. P., Linton, M., McCall, R. D. *et al.* (2008) The combined effects of high pressure and nisin on germination and inactivation of *Bacillus spores* in milk, *Journal of Applied Microbiology* **105**: 78–87.
- Blake, K. L. and O'Neill, A. J. (2013) Transposon library screening for identification of genetic loci participating in intrinsic susceptibility and acquired resistance to antistaphylococcal agents, *Journal of Antimicrobial Chemotherapy* **68**: 12–16.
- Bottiger, T., Schneider, T., Martinez, B. *et al.* (2009) Influence of Ca(2+) ions on the activity of lantibiotics containing a mersacidin-like lipid II binding motif, *Applied and Environmental Microbiology* **75**: 4427–4434.
- Boussouel, N., Mathieu, F., Benoit, V. *et al.* (1999) Response surface methodology, an approach to predict the effects of a lactoperoxidase system, Nisin, alone or in combination, on *Listeria monocytogenes* in skim milk, *Journal of Applied Microbiology* **86**: 642–652.
- Boussouel, N., Mathieu, F., Revol-Junelles, A. M. and Milliere, J. B. (2000) Effects of combinations of lactoperoxidase system and nisin on the behaviour of *Listeria*

- monocytogenes* ATCC 15313 in skim milk, *International Journal of Food Microbiology* **61**: 169–175.
- Bouttefroy, A., Mansour, M., Linder, M. and Milliere, J. B. (2000) Inhibitory combinations of nisin, sodium chloride, and pH on *Listeria monocytogenes* ATCC 15313 in broth by an experimental design approach, *International Journal of Food Microbiology* **54**: 109–115.
- Boziaris, I. S., Humpheson, L. and Adams, M. R. (1998) Effect of nisin on heat injury and inactivation of *Salmonella enteritidis* PT4, *International Journal of Food Microbiology* **43**: 7–13.
- Breukink, E., Wiedemann, I., van Kraaij, C. *et al.* (1999) Use of the cell wall precursor lipid II by a pore-forming peptide antibiotic, *Science* **286**: 2361–2364.
- Brewer, R., Adams, M. R. and Park, S. F. (2002) Enhanced inactivation of *Listeria monocytogenes* by nisin in the presence of ethanol, *Letters in Applied Microbiology* **34**: 18–21.
- Brurberg, M. B., Nes, I. F. and Eijsink, V. G. (1997) Pheromone-induced production of antimicrobial peptides in *Lactobacillus*, *Molecular Microbiology* **26**: 347–360.
- Budu-Amoako, E., Ablett, R. F., Harris, J. and Delves-Broughton, J. (1999) Combined effect of nisin and moderate heat on destruction of *Listeria monocytogenes* in cold-pack lobster meat, *Journal of Food Protection* **62**: 46–50.
- Buncic, S., Fitzgerald, S., Bell, C. M. and Hudson, R. G. (1995) Individual and combined listericidal effects of sodium lactate, potassium sorbate, nisin, and curing salts at refrigeration temperatures, *Journal of Food Safety* **15**: 247–264.
- Calderon-Miranda, M. L., Barbosa-Canovas, G. V. and Swanson, B. G. (1999a) Inactivation of *Listeria innocua* in liquid whole egg by pulsed electric fields and nisin, *International Journal of Food Microbiology* **51**: 7–17.
- Calderon-Miranda, M. L., Barbosa-Canovas, G. V. and Swanson, B. G. (1999b) Inactivation of *Listeria innocua* in skim milk by pulsed electric fields and nisin, *International Journal of Food Microbiology* **51**: 19–30.
- Calderon-Miranda, M. L., Barbosa-Canovas, G. V. and Swanson, B. G. (1999c) Transmission electron microscopy of *Listeria innocua* treated by pulsed electric fields and nisin in skimmed milk, *International Journal of Food Microbiology* **51**: 31–38.
- Cao, M. and Helmann, J. D. (2004) The *Bacillus subtilis* extracytoplasmic-function sigmaX factor regulates modification of the cell envelope and resistance to cationic antimicrobial peptides, *Journal of Bacteriology* **186**: 1136–1146.
- CDC (US Centers for Disease Control and Prevention) (2008a) *National Health and Nutrition Examination Survey data, 2003–2004*. National Center for Health Statistics, Hyattsville, MD.
- CDC (US Centers for Disease Control and Prevention) (2008b) *National Health and Nutrition Examination Survey data, 2005–2006*. National Center for Health Statistics, Hyattsville, MD.
- Cebrian, R., Banos, A., Valdivia, E. *et al.* (2012) Characterization of functional, safety, and probiotic properties of *Enterococcus faecalis* UGRA10, a new AS-48-producer strain, *Food Microbiology* **30**: 59–67.
- Chaillou, S., Postma, P. W., and Pouwels, P. H. (2001) Contribution of the phosphoenolpyruvate: mannose phosphotransferase system to carbon catabolite repression in *Lactobacillus pentosus*, *Microbiology* **147**: 671–679.
- Chen, C. M., Sebranek, J. G., Dickson, J. S., and Mendonca, A. F. (2004) Combining pediocin with post-packaging irradiation for control of *Listeria monocytogenes* on frankfurters, *Journal of Food Protection* **67**: 1866–1875.
- Chen, H., and Hoover, D. G. (2003) Bacteriocins and their food applications, *Comprehensive Reviews in Food Science and Food Safety* **2**: 82–100.

- Chen, Y., Ludescher, R. D., and Montville, T. J. (1997) Electrostatic interactions, but not the YGNGV consensus motif, govern the binding of pediocin PA-1 and its fragments to phospholipid vesicles, *Applied and Environmental Microbiology* **63**: 4770–4777.
- Chumchalova, J., Josephsen, J., and Plockova, M. (1998) The antimicrobial activity of acidocin CH5 in MRS broth and milk with added NaCl, NaNO₃ and lysozyme, *International Journal of Food Microbiology* **43**: 33–38.
- Cintas, L. M., Casaus, P., Holo, H. *et al.* (1998) Enterocins L50A and L50B, two novel bacteriocins from *Enterococcus faecium* L50, are related to staphylococcal hemolysins, *Journal of Bacteriology* **180**: 1988–1994.
- Claypool, L., Heinemann, B., Voris, L. and Stumbo, C. R. (1966) Residence time of nisin in the oral cavity following consumption of chocolate milk containing nisin, *Journal of Dairy Science* **49**: 314–316.
- Cleveland, J., Montville, T. J., Nes, I. F. and Chikindas, M. L. (2001) Bacteriocins: safe, natural antimicrobials for food preservation, *International Journal of Food Microbiology* **71**: 1–20.
- Coderre, P. E. and Somkuti, G. A. (1999) Cloning and expression of the pediocin operon in *Streptococcus thermophilus* and other lactic fermentation bacteria, *Current Microbiology* **39**: 295–301.
- Cornforth, D. M. and Foster, K. R. (2013) Competition sensing: the social side of bacterial stress responses, *Nature Reviews in Microbiology* **11**: 285–293.
- Cosentino, S., Fadda, M. E., Deplano, M. *et al.* (2012) Antilisterial activity of nisin-like bacteriocin-producing *Lactococcus lactis* subsp. *lactis* isolated from traditional Sardinian dairy products, *Journal of Biomedical Biotechnology* **2012**: 376428.
- Cotter, P. D., Guinane, C. M. and Hill, C. (2002) The LisRK signal transduction system determines the sensitivity of *Listeria monocytogenes* to nisin and cephalosporins, *Antimicrobial Agents and Chemotherapy* **46**: 2784–2790.
- Cotter, P. D., Hill, C. and Ross, R. P. (2005a) Bacterial lantibiotics: strategies to improve therapeutic potential, *Current Protein Peptide Science* **6**: 61–75.
- Cotter, P. D., Hill, C. and Ross, R. P. (2005b) Bacteriocins: developing innate immunity for food, *Nature Reviews in Microbiology* **3**: 777–788.
- Cotter, P. D., Deegan, L. H., Lawton, E. M. *et al.* (2006) Complete alanine scanning of the two-component lantibiotic lactacin 3147: generating a blueprint for rational drug design, *Molecular Microbiology* **62**: 735–747.
- Crandall, A. D. and Montville, T. J. (1998) Nisin resistance in *Listeria monocytogenes* ATCC 700302 is a complex phenotype, *Applied and Environmental Microbiology* **64**: 231–237.
- Dalet, K., Cenatiempo, Y., Cossart, P. and Hechard, Y. (2001) A sigma(54)-dependent PTS permease of the mannose family is responsible for sensitivity of *Listeria monocytogenes* to mesentericin Y105, *Microbiology* **147**: 3263–3269.
- Davies, E. A., Bevis, H. E. and Delves-Broughton, J. (1997) The use of the bacteriocin, nisin, as a preservative in ricotta-type cheeses to control the food-borne pathogen *Listeria monocytogenes*, *Letters in Applied Microbiology* **24**: 343–346.
- De Vuyst, L. and Leroy, F. (2007) Bacteriocins from lactic acid bacteria: production, purification, and food applications, *Journal of Molecular Microbiology and Biotechnology* **13**: 194–199.
- Delavenne, E., Mounier, J., Deniel, F. *et al.* (2012) Biodiversity of antifungal lactic acid bacteria isolated from raw milk samples from cow, ewe and goat over one-year period, *International Journal of Food Microbiology* **155**: 185–190.

- Diaz, M., Valdivia, E., Martinez-Bueno, M. *et al.* (2003) Characterization of a new operon, as-48EFGH, from the as-48 gene cluster involved in immunity to enterocin AS-48, *Applied and Environmental Microbiology* **69**: 1229–1236.
- Diep, D. B., Havarstein, L. S. and Nes, I. F. (1996) Characterization of the locus responsible for the bacteriocin production in *Lactobacillus plantarum* C11, *Journal of Bacteriology* **178**: 4472–4483.
- Diep, D. B., Axelsson, L., Grefslı, C. and Nes, I. F. (2000) The synthesis of the bacteriocin sakacin A is a temperature-sensitive process regulated by a pheromone peptide through a three-component regulatory system, *Microbiology* **146** (Pt 9): 2155–2160.
- Diep, D. B., Myhre, R., Johnsborg, O. *et al.* (2003) Inducible bacteriocin production in *Lactobacillus* is regulated by differential expression of the *pln* operons and by two antagonizing response regulators, the activity of which is enhanced upon phosphorylation, *Molecular Microbiology* **47**: 483–494.
- Diep, D. B., Skaugen, M., Salehian, Z. *et al.* (2007) Common mechanisms of target cell recognition and immunity for class II bacteriocins, *Proceedings of the National Academy of Sciences U S A* **104**: 2384–2389.
- Du, L., Somkuti, G. A. and Renye, J. A., Jr. (2012) Molecular analysis of the bacteriocin-encoding plasmid pDGL1 from *Enterococcus durans* and genetic characterization of the durancin GL locus, *Microbiology* **158**: 1523–1532.
- EFSA (The European Food Safety Authority) (2006) The use of nisin (E 234) as a food additive, *The European Food Safety Authority Journal* **314**: 1–16.
- Eijsink, V. G., Skeie, M., Middelhoven, P. H. *et al.* (1998) Comparative studies of class IIa bacteriocins of lactic acid bacteria, *Applied and Environmental Microbiology* **64**: 3275–3281.
- Eijsink, V. G., Axelsson, L., Diep, D. B. *et al.* (2002) Production of class II bacteriocins by lactic acid bacteria; an example of biological warfare and communication, *Antonie Van Leeuwenhoek* **81**: 639–654.
- Farkas, J., Polyak-Feher, K., Andrassy, E. and Meszaros, L. (2002) Improvement of microbiological safety of sous-vide meals by gamma radiation, *Radiation Physics and Chemistry* **63**: 345–348.
- Farkas, J., Andrassy, E., Meszaros, L. and Simon, A. (2003) Increased salt- and nisin-sensitivity of pressure-injured bioluminescent *Listeria monocytogenes*, *Acta Microbiologica et Immunologica Hungarica* **50**: 331–337.
- FDA (US Food and Drug Administration) (1988) Nisin Preparation: Affirmation of GRAS status as direct human food ingredient. *Federal Register* **53**, 11247–11251.
- FDA (US Food and Drug Administration) (2013) Nisin Preparation. CFR - Code of Federal Regulations Title 21, Pt. 184.1538.
- Fenelon, M. A., Ryan, M. P., Rea, M. C. *et al.* (1998) Elevated temperature ripening of reduced fat Cheddar made with or without lacticin 3147 producing starter cultures, *Journal of Dairy Science* **82**: 10–22.
- Ferreira, M. A. and Lund, B. M. (1996) The effect of nisin on *Listeria monocytogenes* in culture medium and long-life cottage cheese, *Letters in Applied Microbiology* **22**: 433–438.
- Fimland, G., Blingsmo, O. R., Sletten, K. *et al.* (1996) New biologically active hybrid bacteriocins constructed by combining regions from various pediocin-like bacteriocins: the C-terminal region is important for determining specificity, *Applied and Environmental Microbiology* **62**: 3313–3318.
- Fimland, G., Johnsen, L., Axelsson, L. *et al.* (2000) A C-terminal disulfide bridge in pediocin-like bacteriocins renders bacteriocin activity less temperature dependent and

- is a major determinant of the antimicrobial spectrum, *Journal of Bacteriology* **182**: 2643–2648.
- Fontaine, L. and Hols, P. (2008) The inhibitory spectrum of thermophilin 9 from *Streptococcus thermophilus* LMD-9 depends on the production of multiple peptides and the activity of BlpG(St), a thiol-disulfide oxidase, *Applied and Environmental Microbiology* **74**: 1102–1110.
- Fontaine, L., Boutry, C., Guedon, E. *et al.* (2007) Quorum-sensing regulation of the production of Blp bacteriocins in *Streptococcus thermophilus*, *Journal of Bacteriology* **189**: 7195–7205.
- Fowler, G. G. (1973) Toxicology of nisin, *Food Cosmetic Toxicology* **11**: 351–352.
- Franz, C. M., van Belkum, M. J., Worobo, R. W. *et al.* (2000) Characterization of the genetic locus responsible for production and immunity of carnobacteriocin A: the immunity gene confers cross-protection to enterocin B, *Microbiology* **146** (Pt 3): 621–631.
- Frazer, A., Sharratt, M., and Hickman, J. (1962) Biological effects of food additives, *Journal of Science Food and Agriculture* **13**: 32–42.
- Gajic, O., Buist, G., Kojic, M. *et al.* (2003) Novel mechanism of bacteriocin secretion and immunity carried out by lactococcal multidrug resistance proteins, *Journal of Biological Chemistry* **278**: 34291–34298.
- Gallo, L. I., Pilosof, A. M. and Jagus, R. J. (2007) Effect of the sequence of nisin and pulse electric fields treatments and mechanisms involved in the inactivation of *Listeria innocua* in whey, *Journal of Food Protection* **79**: 188–193.
- Galvez, A., Abriouel, H., Lopez, R. L. and Ben Omar, N. (2007a) Bacteriocin-based strategies for food biopreservation, *International Journal of Food Microbiology* **120**: 51–70.
- Galvez, A., Abriouel, H., Lopez, R. L. and Omar, N. B. (2007b) Bacteriocin-based strategies for food biopreservation, *Food Microbiology* **120**: 51–70.
- Gao, Y., Weifen, Q., Wu, D. and Fu, Q. (2011) Assessment of *Clostridium perfringens* spore response to high hydrostatic pressure and heat with nisin, *Applied Biochemistry and Biotechnology* **164**: 1083–1095.
- Garcia-Graells, C., Masschalck, B. and Michiels, C. W. (1999) Inactivation of *Escherichia coli* in milk by high-hydrostatic-pressure treatment in combination with antimicrobial peptides, *Journal of Food Protection* **62**: 1248–1254.
- Garcia, P., Martinez, B., Rodriguez, L. and Rodriguez, A. (2010a) Synergy between the phage endolysin LysH5 and nisin to kill *Staphylococcus aureus* in pasteurized milk, *International Journal of Food Microbiology* **141**: 151–155.
- Garcia, P., Rodriguez, L., Rodriguez, A. and Martinez, B. (2010b) Food biopreservation: promising strategies using bacteriocins, bacteriophages and endolysins, *Trends in Food Science and Technology* **21**: 373–382.
- Garde, S., Tomillo, J., Gaya, P. *et al.* (2002) Proteolysis in Hispanic cheese manufactured using a mesophilic starter, a thermophilic starter, and bacteriocin-producing *Lactococcus lactis* subsp. *lactis* INIA 415 adjunct culture, *Journal of Agricultural Food Chemistry* **50**: 3479–3485.
- Georgalaki, M., Papadimitriou, K., Anastasiou, R. *et al.* (2013) Macedovicin, the second food-grade lantibiotic produced by *Streptococcus macedonicus* ACA-DC 198, *Food Microbiology* **33**: 124–130.
- Giannou, E., Kakouri, A., Matijasic, B. B. *et al.* (2009) Fate of *Listeria monocytogenes* on fully ripened Greek Graviera cheese stored at 4, 12, or 25 degrees C in air or vacuum packages: *in situ* PCR detection of a cocktail of bacteriocins potentially contributing to pathogen inhibition, *Journal of Food Protection* **72**: 531–538.

- Gill, A. O. and Holley, R. A. (2003) Interactive inhibition of meat spoilage and pathogenic bacteria by lysozyme, nisin and EDTA in the presence of nitrite and sodium chloride at 24 degrees C, *International Journal of Food Microbiology* **80**: 251–259.
- Giotis, E. S., Julotok, M., Wilkinson, B. J. *et al.* (2008) Role of sigma B factor in the alkaline tolerance response of *Listeria monocytogenes* 10403S and cross-protection against subsequent ethanol and osmotic stress, *Journal of Food Protection* **71**: 1481–1485.
- Giraffa, G., Carminati, D. and Tarelli, G. T. (1995) Inhibition of *Listeria innocua* in milk by bacteriocin-producing *Enterococcus faecium* 7C5, *Journal of Food Protection* **96**: 165–172.
- Glass, K. A., Bhanu, P. B., Schlyter, J. H. *et al.* (1995) Effects of acid type and ALTATM 2431 on *Listeria monocytogenes* in a Queso Blanco type of cheese, *Journal of Food Protection* **58**: 737–741.
- Grande, M. J., Lucas, R., Abriouel, H. *et al.* (2006) Inhibition of toxicogenic *Bacillus cereus* in rice-based foods by enterocin AS-48, *International Journal of Food Microbiology* **106**: 185–194.
- Gravesen, A., Warthoe, P., Knochel, S. and Thirstrup, K. (2000) Restriction fragment differential display of pediocin-resistant *Listeria monocytogenes* 412 mutants shows consistent overexpression of a putative beta-glucoside-specific PTS system, *Microbiology* **146** (Pt 6): 1381–1389.
- Gravesen, A., Sorensen, K., Aarestrup, F. M. and Knochel, S. (2001) Spontaneous nisin-resistant *Listeria monocytogenes* mutants with increased expression of a putative penicillin-binding protein and their sensitivity to various antibiotics, *Microbial Drug Resistance* **7**: 127–135.
- Gravesen, A., Ramnath, M., Rechanger, K. B. *et al.* (2002) High-level resistance to class IIa bacteriocins is associated with one general mechanism in *Listeria monocytogenes*, *Microbiology* **148**: 2361–2369.
- Gravesen, A., Kallipolitis, B., Holmstrom, K. *et al.* (2004) *pbp2229*-mediated nisin resistance mechanism in *Listeria monocytogenes* confers cross-protection to class IIa bacteriocins and affects virulence gene expression, *Applied and Environmental Microbiology* **70**: 1669–1679.
- Guder, A., Wiedemann, I. and Sahl, H. G. (2000) Posttranslationally modified bacteriocins – the lantibiotics, *Biopolymers* **55**: 62–73.
- Guder, A., Schmitter, T., Wiedemann, I. *et al.* (2002) Role of the single regulator MrsR1 and the two-component system MrsR2/K2 in the regulation of mersacidin production and immunity, *Applied and Environmental Microbiology* **68**: 106–113.
- Hauben, K. J. A., Wuytack, E. Y., Soontjens, C. C. F. and Michiels, C. W. (1996) High pressure transient sensitization of *Escherichia coli* to lysozyme and nisin by disruption of outer membrane permeability, *Journal of Food Protection* **59**: 350–355.
- Havarstein, L. S., Diep, D. B. and Nes, I. F. (1995) A family of bacteriocin ABC transporters carry out proteolytic processing of their substrates concomitant with export, *Molecular Microbiology* **16**: 229–240.
- He, L. and Chen, W. (2006) Synergistic activity of nisin with cell-free supernatant of *Bacillus licheniformis* ZJU12 against food-borne bacteria, *Food Research International* **39**: 905–909.
- Hechard, Y. and Sahl, H. G. (2002) Mode of action of modified and unmodified bacteriocins from Gram-positive bacteria, *Biochimie* **84**: 545–557.
- Hechard, Y., Pelletier, C., Cenatiempo, Y. and Frere, J. (2001) Analysis of sigma(54)-dependent genes in *Enterococcus faecalis*: a mannose PTS permease (EII(Man))

- is involved in sensitivity to a bacteriocin, mesentericin Y105, *Microbiology* **147**: 1575–1580.
- Herlander, I. M., von Wright, A. and Mattila-Sandholm, T. (1997) Potential of lactic acid bacteria and novel antimicrobials against Gram-negative bacteria, *Trends in Food Science and Technology* **8**: 146–150.
- Hols, P., Hancy, F., Fontaine, L. *et al.* (2005) New insights in the molecular biology and physiology of *Streptococcus thermophilus* revealed by comparative genomics, *FEMS Microbiological Reviews* **29**: 435–463.
- Hoover, D. G. (1993) Pressure effects on biological systems, *Food Technology* **47**: 150–155.
- Hsu, S. T., Breukink, E., Tischenko, E. *et al.* (2004) The nisin-lipid II complex reveals a pyrophosphate cage that provides a blueprint for novel antibiotics, *Nature Structural and Molecular Biology* **11**: 963–967.
- Ingram, L. C. (1969) Synthesis of the antibiotic nisin: formation of lanthionine and beta-methyl-lanthionine, *Biochimica Biophysica Acta* **184**: 216–219.
- Islam, M. R., Nishie, M., Nagao, J. *et al.* (2012) Ring A of nukacin ISK-1: a lipid II-binding motif for type-A(II) lantibiotic, *Journal of the American Chemical Society* **134**: 3687–3690.
- Jarvis, B. (1967) Resistance to nisin and production of nisin-inactivating enzymes by several *Bacillus* species, *Journal of General Microbiology* **47**: 33–48.
- Jimenez-Diaz, R., Ruiz-Barba, J. L., Cathcart, D. P. *et al.* (1995) Purification and partial amino acid sequence of plantaricin S, a bacteriocin produced by *Lactobacillus plantarum* LPCO10, the activity of which depends on the complementary action of two peptides, *Applied and Environmental Microbiology* **61**: 4459–4463.
- Jin, T. (2010) Inactivation of *Listeria monocytogenes* in skim milk and liquid egg white by antimicrobial bottle coating with polylactic acid and nisin, *Journal of Food Science* **75**: 83–88.
- Joerger, M. C. and Klaenhammer, T. R. (1986) Characterization and purification of helveticin J and evidence for a chromosomally determined bacteriocin produced by *Lactobacillus helveticus* 481, *Journal of Bacteriology* **167**: 439–446.
- Johnsen, L., Fimland, G. and Nissen-Meyer, J. (2005) The C-terminal domain of pediocin-like antimicrobial peptides (class IIa bacteriocins) is involved in specific recognition of the C-terminal part of cognate immunity proteins and in determining the antimicrobial spectrum, *Journal of Biological Chemistry* **280**: 9243–9250.
- Jones, E., Salin, V. and Williams, G. W. (2005). Nisin and the Market for Commercial Bacteriocins. Texas Agribusiness Market Research Center Consumer and Product Research Report, Texas A&M University, College Station, TX.
- Juneja, V. K., Dwivedi, H. P. and Yan, X. (2012) Novel natural food antimicrobials, *Annual Review of Food Science and Technology* **3**: 381–403.
- Jydegaard, A. M., Gravesen, A. and Knochel, S. (2000) Growth condition-related response of *Listeria monocytogenes* 412 to bacteriocin inactivation, *Letters in Applied Microbiology* **31**: 68–72.
- Kalchayanand, N., Hanlin, M. B. and Ray, B. (1992) Sublethal injury makes Gram-negative and resistant Gram-positive bacteria sensitive to the bacteriocins, pediocin AcH and nisin, *Letters in Applied Microbiology* **16**: 239–243.
- Kalchayanand, N., Sikes, A., Dunne, C. P. and Ray, B. (1998) Interaction of hydrostatic pressure, time and temperature of pressurization and pediocin AcH on inactivation of foodborne bacteria, *Journal of Food Protection* **61**: 425–431.

- Kalchayanand, N., Dunne, C. P., Sikes, A. and Ray, B. (2004) Germination induction and inactivation of *Clostridium* spores at medium-range hydrostatic pressure treatment, *Innovative Food Science and Emerging Tehnologies* **5**: 277–283.
- Kamau, D. N., Doores, S. and Pruitt, K. M. (1990) Antibacteria activity of the lactoperoxidase system against *Listeria monocytogenes* and *Staphylococcus aureus* in milk, *Journal of Food Protection* **53**: 1010–1014.
- Kato, M. and Hayashi, R. (1999) Effects of high pressure on lipids of biomembranes for understanding high-pressure-induced biological phenomena, *Bioscience Biotechnology and Biochemistry* **68**: 1321–1328.
- Kaur, G., Singh, T. P. and Malik, R. K. (2013) Antibacterial efficacy of nisin, pediocin 34 and enterocin FH99 against *Listeria monocytogenes* and cross resistance of its bacteriocin resistant variants to common food preservatives, *Brazilian Journal of Microbiology* **44**: 63–71.
- Kazazic, M., Nissen-Meyer, J. and Fimland, G. (2002) Mutational analysis of the role of charged residues in target-cell binding, potency and specificity of the pediocin-like bacteriocin sakacin P, *Microbiology* **148**: 2019–2027.
- Kingston, A. W., Liao, X. and Helmann, J. D. (2013) Contributions of the sigma W, sigma M and sigma X regulons to the lantibiotic resistome of *Bacillus subtilis*, *Molecular Microbiology* **90**: 502–518.
- Kjos, M., Nes, I. F. and Diep, D. B. (2009) Class II one-peptide bacteriocins target a phylogenetically defined subgroup of mannose phosphotransferase systems on sensitive cells, *Microbiology* **155**: 2949–2961.
- Kjos, M., Snipen, L., Salehian, Z. *et al.* (2010) The abi proteins and their involvement in bacteriocin self-immunity, *Journal of Bacteriology* **192**: 2068–2076.
- Klaenhammer, T. R. (1993) Genetics of bacteriocins produced by lactic acid bacteria, *FEMS Microbiology Reviews* **12**: 39–85.
- Kleerebezem, M. and Quadri, L. E. (2001) Peptide pheromone-dependent regulation of antimicrobial peptide production in Gram-positive bacteria: a case of multicellular behavior, *Peptides* **22**: 1579–1596.
- Knerr, P. J., Oman, T. J., Garcia De Gonzalo, C. V. *et al.* (2012) Non-proteinogenic amino acids in lacticin 481 analogues result in more potent inhibition of peptidoglycan transglycosylation, *ACS Chemical Biology* **7**: 1791–1795.
- Kovacs, M., Halfmann, A., Fedtke, I. *et al.* (2006) A functional *dlt* operon, encoding proteins required for incorporation of d-alanine in teichoic acids in gram-positive bacteria, confers resistance to cationic antimicrobial peptides in *Streptococcus pneumoniae*, *Journal of Bacteriology* **188**: 5797–5805.
- Kozakova, D., Holubova, J., Plockova, M. *et al.* (2005) Impedance measurement of growth of lactic acid bacteria in the presence of nisin and lysozyme, *European Food Research and Technology* **221**: 774–778.
- Kramer, N. E., Smid, E. J., Kok, J. *et al.* (2004) Resistance of Gram-positive bacteria to nisin is not determined by lipid II levels, *FEMS Microbiology Letters* **239**: 157–161.
- Kreth, J., Merritt, J., Bordador, C. *et al.* (2004) Transcriptional analysis of mutacin I (*mutA*) gene expression in planktonic and biofilm cells of *Streptococcus mutans* using fluorescent protein and glucuronidase reporters, *Oral Microbiology and Immunology* **19**: 252–256.
- Kuipers, O. P., Beerthuyzen, M. M., de Ruyter, P. G. *et al.* (1995) Autoregulation of nisin biosynthesis in *Lactococcus lactis* by signal transduction, *Journal of Biological Chemistry* **270**: 27299–27304.

- Kumari, A., Akkoc, N. and Akcelik, M. (2012) Purification and partial characterization of bacteriocin produced by *Lactococcus lactis* ssp. *lactis* LL171, *World Journal of Microbiology and Biotechnology* **28**: 1647–1655.
- Langer, A. J., Ayers, T., Grass, J. *et al.* (2012) Nonpasteurized dairy products, disease outbreaks, and state laws-United States, 1993-2006, *Emerging Infectious Diseases* **18**: 385–391.
- Laukova, A., Czikkova, S., Dobransky, T. and Burdova, O. (1999) Inhibition of *Listeria monocytogenes* and *Staphylococcus aureus* by enterocin CCM4231 in milk products, *Food Microbiology* **16**: 93–99.
- Lee, S., Iwata, T. and Oyagi, H. (1993) Effects of salts on conformational change of basic amphipathic peptides from beta-structure to alpha-helix in the presence of phospholipid liposomes and their channel-forming ability, *Biochimica et Biophysica Acta* **1151**: 75–82.
- Leistner, L. (1995). *Principles and Applications of Hurdle Technology*. Blackie Academic and Professional, London.
- Leistner, L. (1999). *Combined Methods for Food Preservation*. Marcel Dekker, New York.
- Leistner, L. (2000) Basic aspects of food preservation by hurdle technology, *International Journal of Food Microbiology* **55**: 181–186.
- Leistner, L. and Gorris, L. G. M. (1995) Food Preservation by hurdle technology, *Trends in Food Science and Technology* **6**: 41–46.
- Li, J., Chikindas, M. L., Ludescher, R. D. and Montville, T. J. (2002) Temperature- and surfactant-induced membrane modifications that alter *Listeria monocytogenes* nisin sensitivity by different mechanisms, *Applied and Environmental Microbiology* **68**: 5904–5910.
- Liang, Z., Mittal, G. S. and Griffiths, M. W. (2002) Inactivation of *Salmonella Typhimurium* in orange juice containing antimicrobial agents by pulsed electric field, *Journal of Food Protection* **65**: 1081–1087.
- Liu, W. and Hansen, J. N. (1990) Some chemical and physical properties of nisin, a small-protein antibiotic produced by *Lactococcus lactis*, *Applied and Environmental Microbiology* **56**: 2551–2558.
- Lopez-Exposito, I., Pellegrini, A., Amigo, L. and Recio, I. (2008) Synergistic effect between different milk-derived peptides and proteins, *Journal of Dairy Science* **91**: 2184–2189.
- Lopez-Pedemonte, T. J., Roig-Sagues, A. X., Trujillo, A. J. *et al.* (2003) Inactivation of spores of *Bacillus cereus* in cheese by high hydrostatic pressure with the addition of nisin or lysozyme, *Journal of Dairy Science* **86**: 3075–3081.
- Maisnier-Patin, S., Tatini, S. R. and Richard, J. (1995) Combined effect of nisin and moderate heat on destruction of in milk, *Le Lait* **75**: 81–91.
- Maisnier-Patin, S. and Richard, J. (1996) Cell wall changes in nisin-resistant variants of *Listeria innocua* grown in the presence of high nisin concentrations, *FEMS Microbiology Letters* **140**: 29–35.
- Mansour, M. and Milliere, J. B. (2001) An inhibitory synergistic effect of a nisin-monolaurin combination on *Bacillus sp.* vegetative cells in milk, *Food Microbiology* **18**: 87–94.
- Mansour, M., Amri, D., Bouttefroy, A. *et al.* (1999) Inhibition of *Bacillus licheniformis* spore growth in milk by nisin, monolaurin, and pH combinations, *Journal of Applied Microbiology* **86**: 311–324.
- Martinez-Cuesta, M. C., Fernandez de Palencia, P., Requena, T. and Palaez, C. (1998) Enhancement of proteolysis by a *Lactococcus lactis* bacteriocin producer in a cheese model system, *Journal of Agricultural Food Chemistry* **46**: 3863–3867.

- Masschalck, B., Van Houdt, R. and Michiels, C. W. (2001) High pressure increases bactericidal activity and spectrum of lactoferrin, lactoferricin and nisin, *Journal of Food Microbiology* **64**: 325–332.
- Masuda, Y., Zendo, T., Sawa, N. *et al.* (2011) Characterization and identification of weissellicin Y and weissellicin M, novel bacteriocins produced by *Weissella hellenica* QU 13, *Journal of Applied Microbiology* **112**: 99–108.
- Masuda, Y., Zendo, T. and Sonomoto, K. (2012) New type non-lantibiotic bacteriocins: circular and leaderless bacteriocins, *Beneficial Microbes* **3**: 3–12.
- Mazzotta, A. S. and Montville, T. J. (1997) Nisin induces changes in membrane fatty acid composition of *Listeria monocytogenes* nisin-resistant strains at 10 degrees C and 30 degrees C, *Journal of Applied Microbiology* **82**: 32–38.
- Mazzotta, A. S., Crandall, A. D. and Montville, T. J. (1997) Nisin resistance in *Clostridium botulinum* spores and vegetative cells, *Applied and Environmental Microbiology* **63**: 2654–2659.
- McAuliffe, O., Ryan, M. P., Ross, R. P. *et al.* (1998) Lacticin 3147, a broad-spectrum bacteriocin which selectively dissipates the membrane potential, *Applied and Environmental Microbiology* **64**: 439–445.
- McAuliffe, O., O’Keeffe, T., Hill, C. and Ross, R. P. (2001) Regulation of immunity to the two-component lantibiotic, lacticin 3147, by the transcriptional repressor LtnR, *Molecular Microbiology* **39**: 982–993.
- McBride, S. M. and Sonenshein, A. L. (2011) The *dlt* operon confers resistance to cationic antimicrobial peptides in *Clostridium difficile*, *Microbiology* **157**: 1457–1465.
- Miller, K. W., Schamber, R., Osmanagaoglu, O. and Ray, B. (1998) Isolation and characterization of pediocin AcH chimeric protein mutants with altered bactericidal activity, *Applied Environmental Microbiology* **64**: 1997–2005.
- Mills, S., Serrano, L. M., Griffin, C. *et al.* (2011a) Inhibitory activity of *Lactobacillus plantarum* LMG P-26358 against *Listeria innocua* when used as an adjunct starter in the manufacture of cheese, *Microbial Cell Factories* **10**(Suppl 1): S7.
- Mills, S., Stanton, C., Hill, C. and Ross, R. P. (2011b) New developments and applications of bacteriocins and peptides in foods, *Annual Reviews in Food Science and Technology* **2**: 299–329.
- Ming, X. and Daeschel, M. A. (1993) Nisin resistance of foodborne bacteria and the specific responses of *Listeria monocytogenes* Scott A, *Journal of Food Protection* **56**: 944–948.
- Ming, X. and Daeschel, M. A. (1995) Correlation of cellular phospholipid content with nisin resistance of *Listeria monocytogenes* Scott A, *Journal of Food Protection* **58**: 416–420.
- Miteva, V., Ivanova, I., Budakov, I. *et al.* (1998) Detection and characterization of a novel antibacterial substance produced by a *Lactobacillus delbrueckii* strain 1043, *Journal of Applied Microbiology* **85**: 603–614.
- Modi, K. D., Chikindas, M. L. and Montville, T. J. (2000) Sensitivity of nisin-resistant *Listeria monocytogenes* to heat and the synergistic action of heat and nisin, *Letters in Applied Microbiology* **30**: 249–253.
- Montville, T. J. and Chen, Y. (1998) Mechanistic action of pediocin and nisin: recent progress and unresolved questions, *Applied Microbiology and Biotechnology* **50**: 511–519.
- Morgan, S. M., Ross, R. P., and Hill, C. (1997) Increasing starter cell lysis in Cheddar cheese using a bacteriocin-producing adjunct, *Journal of Dairy Science* **80**: 1–10.
- Morgan, S. M., Galvin, M., Kelly, J. *et al.* (1999) Development of a lacticin 3147-enriched whey powder with inhibitory activity against foodborne pathogens, *Journal of Food Protection* **62**: 1011–1016.

- Morgan, S. M., Ross, R. P., Beresford, T. and Hill, C. (2000) Combination of hydrostatic pressure and lactacin 3147 causes increased killing of *Staphylococcus* and *Listeria*, *Journal of Applied Microbiology* **88**: 414–420.
- Morgan, S. M., Galvin, M., Ross, R. P. and Hill, C. (2001) Evaluation of a spray-dried lactacin 3147 powder for the control of *Listeria monocytogenes* and *Bacillus cereus* in a range of food systems, *Letters in Applied Microbiology* **33**: 387–391.
- Morgan, S. M., O'Sullivan, L., Ross, R. P. and Hill, C. (2002) The design of a three strain starter system for Cheddar cheese manufacture exploiting bacteriocin-induced starter lysis, *International Dairy Journal* **12**: 985–993.
- Muller, A., Ulm, H., Reder-Christ, K. *et al.* (2012) Interaction of type A lantibiotics with undecaprenol-bound cell envelope precursors, *Microbial Drug Resistance* **18**: 261–270.
- Munoz, A., Maqueda, M., Galvez, A. *et al.* (2004) Biocontrol of psychrotrophic enterotoxigenic *Bacillus cereus* in a nonfat hard cheese by an enterococcal strain-producing enterocin AS-48, *Journal of Food Protection* **67**: 1517–1521.
- Murray, M. and Richard, J. A. (1997) Comparative study of the antilisterial activity of nisin A and pediocin AcH in fresh ground pork stored aerobically at 5°C, *Journal of Food Protection* **60**: 1534–1540.
- Nakamura, K., Arakawa, K., Kawai, Y. *et al.* (2013) Food preservative potential of gassericin A-containing concentrate prepared from cheese whey culture supernatant of *Lactobacillus gasserii* LA39, *Animal Science Journal* **84**: 144–149.
- Nes, I. F. and Johnsborg, O. (2004) Exploration of antimicrobial potential in LAB by genomics, *Current Opinion in Biotechnology* **15**: 100–104.
- Nieto Lozano, J. C., Meyer, J. N., Sletten, K. *et al.* (1992) Purification and amino acid sequence of a bacteriocin produced by *Pediococcus acidilactici*, *Journal of General Microbiology* **138**: 1985–1990.
- Nilsen, T., Nes, I. F. and Holo, H. (1998) An exported inducer peptide regulates bacteriocin production in *Enterococcus faecium* CTC492, *Journal of Bacteriology* **180**: 1848–1854.
- Nilsen, T., Nes, I. F. and Holo, H. (2003) Enterolysin A, a cell wall-degrading bacteriocin from *Enterococcus faecalis* LMG 2333, *Applied and Environmental Microbiology* **69**: 2975–2984.
- Nilsson, L., Chen, Y., Chikindas, M. L. *et al.* (2000) Carbon dioxide and nisin act synergistically on *Listeria monocytogenes*, *Applied and Environmental Microbiology* **66**: 769–774.
- Nissen-Meyer, J., Holo, H., Havarstein, L. S. *et al.* (1992) A novel lactococcal bacteriocin whose activity depends on the complementary action of two peptides, *Journal of Bacteriology* **174**: 5686–5692.
- Nunez, M., Rodriguez, J. L., Garcia, E. *et al.* (1997) Inhibition of *Listeria monocytogenes* by enterocin 4 during the manufacture and ripening of Manchego cheese, *Journal of Applied Microbiology* **83**: 671–677.
- Nursten, H. E. (1997) The flavour of milk and dairy products: I. Milk of different kinds, milk powder, butter and cream, *International Journal of Dairy Technology* **50**: 48–56.
- Nykanen, A., Weckman, K. and Lapvetelainen, A. (2000) Synergistic inhibition of *Listeria monocytogenes* on cold-smoked rainbow trout by nisin and sodium lactate, *International Journal of Food Microbiology* **61**: 63–72.
- O'Sullivan, L., Ross, R. P. and Hill, C. (2003a) A lactacin 481-producing adjunct culture increases starter lysis while inhibiting nonstarter lactic acid bacteria proliferation during Cheddar cheese ripening, *Journal of Applied Microbiology* **95**: 1235–1241.
- O'Sullivan, L., Ryan, M. P., Ross, R. P. and Hill, C. (2003b) Generation of food-grade lactococcal starters which produce the lantibiotics lactacin 3147 and lactacin 481, *Applied and Environmental Microbiology* **69**: 3681–3685.

- Oman, T. J., Knerr, P. J., Bindman, N. A. *et al.* (2012) An engineered lantibiotic synthetase that does not require a leader peptide on its substrate, *Journal of American Chemical Society* **134**: 6952–6955.
- Ortolani, M. B., Moraes, P. M., Perin, L. M. *et al.* (2010) Molecular identification of naturally occurring bacteriocinogenic and bacteriocinogenic-like lactic acid bacteria in raw milk and soft cheese, *Journal of Dairy Science* **93**: 2880–2886.
- Oumer, B. A., Gaya, P., Fernandez-Garcia, E. *et al.* (2001) Proteolysis and formation of volatile compounds in cheese manufactured with a bacteriocin-producing adjunct culture, *Journal of Dairy Research* **68**: 117–129.
- Painter, J. A., Hoekstra, R. M., Ayers, T. *et al.* (2013) Attribution of foodborne illnesses, hospitalizations, and deaths to food commodities by using outbreak data, United States, 1998–2008, *Emerging Infectious Diseases* **19**: 407–415.
- Periago, P. M., Palop, A. and Fernandez, P. S. (2001) Combined effect of nisin, carvacol and thymol on the viability of *Bacillus cereus* heat-treated vegetative cells, *Food Science and Technology International* **7**: 487–492.
- Perin, L. M., Moraes, P. M., Silva, A., Jr, and Nero, L. A. (2012) Lantibiotics biosynthesis genes and bacteriocinogenic activity of *Lactobacillus* spp. isolated from raw milk and cheese, *Folia Microbiology (Praha)* **57**: 183–190.
- Peschel, A., Otto, M., Jack, R. W. *et al.* (1999) Inactivation of the *dlt* operon in *Staphylococcus aureus* confers sensitivity to defensins, protegrins, and other antimicrobial peptides, *Journal of Biological Chemistry* **274**: 8405–8410.
- Piard, J. C., Kuipers, O. P., Rollema, H. S. *et al.* (1993) Structure, organization, and expression of the *lct* gene for lactacin 481, a novel lantibiotic produced by *Lactococcus lactis*, *Journal of Biological Chemistry* **268**: 16361–16368.
- Pintado, C. M. B.S. and Ferreira, M. A. S. S. S., I. (2009) Properties of whey protein-based films containing organic acids and nisin to control *Listeria monocytogenes*, *Journal of Food Protection* **72**: 1891–1896.
- Plockova, M., Stepanek, M., Demnerova, K. *et al.* (1996) Effect of nisin for improvement in shelf life and quality of processed cheese, *Advances in Food Science* **18**: 78–83.
- Pol, I. E. and Smid, E. J. (1999) Combined action of nisin and carvacrol on *Bacillus cereus* and *Listeria monocytogenes*, *Letters in Applied Microbiology* **29**: 166–170.
- Pol, I. E., Mastwijk, H. C., Slump, R. A. *et al.* (2001) Influence of food matrix on inactivation of *Bacillus cereus* by combinations of nisin, pulsed electric field treatment, and carvacrol, *Journal of Food Protection* **64**: 1012–1018.
- Pucci, M. J., Vedamuthu, E. R., Kunka, B. S. and Vandenberg, P. A. (1988) Inhibition of *Listeria monocytogenes* by using bacteriocin PA-1 produced by *Pediococcus acidilactici* PAC 1.0, *Applied and Environmental Microbiology* **54**: 2349–2353.
- Ra, S. R., Qiao, M., Immonen, T. *et al.* (1996) Genes responsible for nisin synthesis, regulation and immunity form a regulon of two operons and are induced by nisin in *Lactococcus lactis* N8, *Microbiology* **142** (Pt 5): 1281–1288.
- Ramnath, M., Beukes, M., Tamura, K. and Hastings, J. W. (2000) Absence of a putative mannose-specific phosphotransferase system enzyme IIAB component in a leucocin A-resistant strain of *Listeria monocytogenes*, as shown by two-dimensional sodium dodecyl sulfate-polyacrylamide gel electrophoresis, *Applied and Environmental Microbiology* **66**: 3098–3101.
- Rayman, K., Malik, N. and Hurst, A. (1983) Failure of nisin to inhibit outgrowth of *Clostridium botulinum* in a model cured meat system, *Applied and Environmental Microbiology* **46**: 1450–1452.

- Renye, J. A., Jr, and Somkuti, G. A. (2009) Insertion of a heterologous gene construct into a non-functional ORF of the *Streptococcus thermophilus* chromosome, *Biotechnology Letters* **31**: 759–764.
- Renye, J. A., Jr, and Somkuti, G. A. (2010) Nisin-induced expression of pediocin in dairy lactic acid bacteria, *Journal of Applied Microbiology* **108**: 2142–2151.
- Revilla-Guarinos, A., Gebhard, S., Alcantara, C. *et al.* (2013) Characterization of a regulatory network of peptide antibiotic detoxification modules in *Lactobacillus casei* BL23, *Applied and Environmental Microbiology* **79**: 3160–3170.
- Rilla, N., Martinez, B., Delgado, T. and Rodriguez, A. (2003) Inhibition of *Clostridium tyrobutyricum* in Vidiago cheese by *Lactococcus lactis* ssp. *lactis* IPLA 729, a nisin Z producer, *International Journal of Food Microbiology* **85**: 23–33.
- Rilla, N., Martinez, B. and Rodriguez, A. (2004) Inhibition of a methicillin-resistant *Staphylococcus aureus* strain in Afuega'l Pitu cheese by the nisin Z-producing strain *Lactococcus lactis* subsp. *lactis* IPLA 729, *Journal of Food Protection* **67**: 928–933.
- Rince, A., Dufour, A., Uguen, P. *et al.* (1997) Characterization of the lacticin 481 operon: the *Lactococcus lactis* genes *lctF*, *lctE*, and *lctG* encode a putative ABC transporter involved in bacteriocin immunity, *Applied and Environmental Microbiology* **63**: 4252–4260.
- Robichon, D., Gouin, E., Debarbouille, M. *et al.* (1997) The *rpoN* (sigma54) gene from *Listeria monocytogenes* is involved in resistance to mesentericin Y105, an antibacterial peptide from *Leuconostoc mesenteroides*, *Journal of Bacteriology* **179**: 7591–7594.
- Rodriguez, E., Arques, J. L., Nunez, M. *et al.* (2005) Combined effect of high-pressure treatments and bacteriocin-producing lactic acid bacteria on inactivation of *Escherichia coli* O157:H7 in raw-milk cheese, *Applied and Environmental Microbiology* **71**: 3399–3404.
- Ryan, M. P., Rea, M. C., Hill, C. and Ross, R. P. (1996) An application in cheddar cheese manufacture for a strain of *Lactococcus lactis* producing a novel broad-spectrum bacteriocin, lacticin 3147, *Applied and Environmental Microbiology* **62**: 612–619.
- Sahl, H. G. and Bierbaum, G. (1998) Lantibiotics: biosynthesis and biological activities of uniquely modified peptides from gram-positive bacteria, *Annual Reviews of Microbiology* **52**: 41–79.
- Santi, L., Cerrutti, P., Pilosof, A. M. and de Huergo, M. S. (2003) Optimization of the conditions for electroporation and the addition of nisin for *Pseudomonas aeruginosa* inhibition, *Revista Argentina de Microbiologia* **35**: 198–204.
- Sawa, N., Zendo, T., Kiyofuji, J. *et al.* (2009) Identification and characterization of lactocyclin Q, a novel cyclic bacteriocin produced by *Lactococcus* sp. strain QU 12, *Applied and Environmental Microbiology* **75**: 1552–1558.
- Scannell, A. G., Ross, R. P., Hill, C. and Arendt, E. (2000) An effective lacticin biopreservative in fresh pork sausage, *Journal of Food Protection* **63**: 370–375.
- Schillinger, U., Geisen, R. and Holzapfel, W. H. (1996) Potential of antagonistic microorganisms and bacteriocins for the biological preservation of foods., *Trends in Food Science and Technology* **7**: 158–164.
- Schlyter, J. H., Glass, K. A., Loeffelholz, J. *et al.* (1993) The effects of diacetate with nitrite, lactate, or pediocin on the viability of *Listeria monocytogenes* in turkey slurries, *International Journal of Food Microbiology* **19**: 271–281.
- Schved, F., Henis, Y. and Juven, B. J. (1994) Response of spheroplasts and chelator-permeabilized cells of gram-negative bacteria to the action of the bacteriocins pediocin SJ-1 and nisin, *International Journal of Food Microbiology* **21**: 305–314.
- Severina, E., Severin, A. and Tomasz, A. (1998) Antibacterial efficacy of nisin against multidrug-resistant Gram-positive pathogens, *Journal of Antimicrobial Chemotherapy* **41**: 341–347.

- Shiferaw, B., Yang, S., Cieslak, P. *et al.* (2000) Prevalence of high-risk food consumption and food-handling practices among adults: a multistate survey, 1996 to 1997. The Foodnet Working Group, *Journal of Food Protection* **63**: 1538–1543.
- Shtenberg, A. I. (1973) Toxicity of nisin, *Food and Cosmetics Toxicology* **11**: 352.
- Siezen, R. J., Kuipers, O. P. and de Vos, W. M. (1996) Comparison of lantibiotic gene clusters and encoded proteins, *Antonie Van Leeuwenhoek* **69**: 171–184.
- Skandamis, P. N., Yoon, Y., Stopforth, J. D. *et al.* (2008) Heat and acid tolerance of *Listeria monocytogenes* after exposure to single and multiple sublethal stresses, *Food Microbiology* **25**: 294–303.
- Sobrinho-Lopez, A. and Martin-Belloso, O. (2008a) Enhancing the lethal effect of high-intensity pulsed electric field in milk by antimicrobial compounds as combined hurdles, *Journal of Dairy Science* **91**: 1759–1768.
- Sobrinho-Lopez, A. and Martin-Belloso, O. (2008b) Use of nisin and other bacteriocins for preservation of dairy products, *International Dairy Journal* **18**: 329–343.
- Sobrinho-Lopez, A., Viedma-Martinez, P., Abriouel, H. *et al.* (2009) The effect of adding antimicrobial peptides to milk inoculated with *Staphylococcus aureus* and processed by high-intensity pulsed-electric field, *Journal of Dairy Science* **92**: 2514–2523.
- Somkuti, G. A. and Steinberg, D. H. (2003) Pediocin production by recombinant lactic acid bacteria, *Biotechnology Letters* **25**: 473–477.
- Stein, T., Heinzmann, S., Dusterhus, S. *et al.* (2005) Expression and functional analysis of the subtilin immunity genes *spaIFEG* in the subtilin-sensitive host *Bacillus subtilis* MO1099, *Journal of Bacteriology* **187**: 822–828.
- Tagg, J. R., Dajani, A. S. and Wannamaker, L. W. (1976) Bacteriocins of gram-positive bacteria, *Bacteriology Review* **40**: 722–756.
- Taylor, J. I., Somer, E. B. and Kruger, L. A. (1985) Antibotulinal effectiveness of nisin-nitrite combinations in culture medium and chicken frankfurteremulsions, *Journal of Food Protection* **48**: 234–249.
- Ter Steeg, P. F., Hellemons, J. C. and Kok, A. E. (1999) Synergistic actions of nisin, sublethal ultrahigh pressure, and reduced temperature on bacteria and yeast, *Applied and Environmental Microbiology* **65**: 4148–4154.
- Terebiznik, M. R., Jagus, R. J., Cerrutti, P. *et al.* (2000) Combined effect of nisin and pulsed electric fields on the inactivation of *Escherichia coli*, *Journal of Food Protection* **63**: 741–746.
- Terebiznik, M. R., Jagus, R. J., Cerrutti, P. *et al.* (2002) Inactivation of *Escherichia coli* by a combination of nisin, pulsed electric fields and water activity reduction by sodium chloride, *Journal of Food Protection* **65**: 1253–1258.
- Thomas, L. V. and Wimpenny, J. W. (1996) Investigation of the effect of combined variations in temperature, pH, and NaCl concentration on nisin inhibition of *Listeria monocytogenes* and *Staphylococcus aureus*, *Applied and Environmental Microbiology* **62**: 2006–2012.
- Thomas, L. V., Davies, E. A., Delves-Broughton, J. and Wimpenny, J. W. (1998) Synergist effect of sucrose fatty acid esters on nisin inhibition of gram-positive bacteria, *Journal of Applied Microbiology* **85**: 1013–1022.

- Twomey, D., Ross, R. P., Ryan, M. *et al.* (2002) Lantibiotics produced by lactic acid bacteria: structure, function and applications, *Antonie Van Leeuwenhoek* **82**: 165–185.
- Uhart, H. M., Ravishankar, S. and Maks, N. D. (2004) Control of *Listeria monocytogenes* with combined antimicrobials on beef franks stored at 4 degrees C, *Journal of Food Protection* **67**: 2296–2301.
- Uljas, H. and Luchansky, J. B. (1995) Characterization of bacteriocins produced by *Lactobacilli* and their use to control calcium lactate crystal-forming lactic acid bacteria in Cheddar cheese, MSc Thesis, University of Wisconsin-Madison, Madison, WI.
- Uymaz, B., Akkoc, N. and Akcelik, M. (2011) Partial characterization of bacteriocins produced by two *Lactobacillus* strains with probiotic properties, *Acta Biologica Hungarica* **62**: 95–105.
- Vadyvaloo, V., Hastings, J. W., van der Merwe, M. J. and Rautenbach, M. (2002) Membranes of class IIa bacteriocin-resistant *Listeria monocytogenes* cells contain increased levels of desaturated and short-acyl-chain phosphatidylglycerols, *Applied and Environmental Microbiology* **68**: 5223–5230.
- Vadyvaloo, V., Arous, S., Gravesen, A. *et al.* (2004a) Cell-surface alterations in class IIa bacteriocin-resistant *Listeria monocytogenes* strains, *Microbiology* **150**: 3025–3033.
- Vadyvaloo, V., Snoep, J. L., Hastings, J. W. and Rautenbach, M. (2004b) Physiological implications of class IIa bacteriocin resistance in *Listeria monocytogenes* strains, *Microbiology* **150**: 335–340.
- van der Meer, J. R., Polman, J., Beerthuyzen, M. M. *et al.* (1993) Characterization of the *Lactococcus lactis* nisin A operon genes *nisP*, encoding a subtilisin-like serine protease involved in precursor processing, and *nisR*, encoding a regulatory protein involved in nisin biosynthesis, *Journal of Bacteriology* **175**: 2578–2588.
- van der Meer, J. R., Rollema, H. S., Siezen, R. J. *et al.* (1994) Influence of amino acid substitutions in the nisin leader peptide on biosynthesis and secretion of nisin by *Lactococcus lactis*, *Journal of Biological Chemistry* **269**: 3555–3562.
- Van Schaik, W., Gahan, G. C. and Hill, C. (1999) Acid-adapted *Listeria monocytogenes* displays enhanced tolerance against the lantibiotics nisin and lacticin 3147, *Journal of Food Protection* **62**: 536–539.
- Vega-Mercado, H., Martin-Belloso, O., Qin, B.-L. *et al.* (1997) Non-thermal food preservation pulsed field electric fields, *Trends in Food Science and Technology* **8**: 151–157.
- Venema, K., Kok, J., Marugg, J. D. *et al.* (1995) Functional analysis of the pediocin operon of *Pediococcus acidilactici* PAC1.0: PedB is the immunity protein and PedD is the precursor processing enzyme, *Molecular Microbiology* **17**: 515–522.
- Vera Pingitore, E., Todorov, S. D., Sesma, F. and Franco, B. D. (2012) Application of bacteriocinogenic *Enterococcus mundtii* CRL35 and *Enterococcus faecium* ST88Ch in the control of *Listeria monocytogenes* in fresh Minas cheese, *Food Microbiology* **32**: 38–47.
- von Staszewski, M. and Jagus, R. J. (2008) Natural antimicrobials: Effect of MicrogardTM and nisin against *Listeria innocua* in liquid cheese whey, *International Dairy Journal* **18**: 255–259.
- Wandling, L. R., Sheldon, B. W. and Foegeding, P. M. (1999) Nisin in milk sensitizes *Bacillus* spores to heat and prevents recovery of survivors, *Journal of Food Protection* **62**: 492–498.
- Wang, L. L. and Johnson, E. A. (1997) Control of *Listeria monocytogenes* by monoglycerides in foods, *Journal of Food Protection* **60**: 131–138.

- Wessels, S., Jelle, B. and Nes, I. F. (1998). Bacteriocins of lactic acid bacteria. Report of the Danish Toxicology Centre, Hoersholm, Denmark.
- Wiedemann, I., Breukink, E., van Kraaij, C. *et al.* (2001) Specific binding of nisin to the peptidoglycan precursor lipid II combines pore formation and inhibition of cell wall biosynthesis for potent antibiotic activity, *Journal of Biological Chemistry* **276**: 1772–1779.
- Wiedemann, I., Bottiger, T., Bonelli, R. R. *et al.* (2006) The mode of action of the lantibiotic lactacin 3147 – a complex mechanism involving specific interaction of two peptides and the cell wall precursor lipid II, *Molecular Microbiology* **61**: 285–296.
- Wilkinson, M. G., Guinee, T. P., O’Callaghan, D. M. and Fox, P. F. (1994) Autolysis and proteolysis in different strains of starter bacteria during Cheddar cheese ripening, *Journal of Dairy Research* **61**: 249–262.
- Wirjantoro, T. I., Lewis, M. J., Grandison, A. S. *et al.* (2001) The effect of nisin on the keeping quality of reduced heat-treated milks, *Journal of Food Protection* **64**: 213–219.
- Wolfson, L. M. and Sumner, S. S. (1994) Antibacterial activity of the lactoperoxidase system against *Salmonella typhimurium* in trypticase soy broth in the presence and absence of heat treatment, *Journal of Food Protection* **57**: 365–368.
- Wulijidigen, Asahina, T., Hara, K. *et al.* (2012) Production of bacteriocin by *Leuconostoc mesenteroides* 406 isolated from Mongolian fermented mare’s milk, airag, *Animal Science Journal* **83**: 704–711.
- Xiao, D., Davidson, P. M. and Zhong, Q. (2011) Spray-dried zein capsules with coencapsulated nisin and thymol as antimicrobial delivery system for enhanced antilisterial properties., *Journal of Agricultural and Food Chemistry* **59**: 7393–7404.
- Xie, L., Miller, L. M., Chatterjee, C. *et al.* (2004) Lactacin 481: *in vitro* reconstitution of lantibiotic synthetase activity, *Science* **303**: 679–681.
- Yamazaki, K., Yamamoto, T., Kawai, Y. and Inoue, N. (2004) Enhancement of antilisterial activity of essential oil constituents by nisin and diglycerol fatty acid ester, *Food Microbiology* **21**: 283–289.
- Zapico, P., Margarita, M., Gaya, P. and Nunez, M. (1998) Synergistic effect of nisin and the lactoperoxidase system on *Listeria monocytogenes* in skim milk, *International Journal of Food Microbiology* **40**: 35–42.
- Zottola, E. A., Yezzi, T. L., Ajao, D. B. and Roberts, R. F. (1994) Utilization of cheddar cheese containing nisin as an antimicrobial agent in other foods, *International Journal of Food Microbiology* **24**: 227–238.

11

Leveraging the Beneficial Compounds of Organic and Pasture Milk

Michael H. Tunick, Diane L. Van Hekken, and Moushumi Paul

Dairy and Functional Foods Research Unit, USDA/ARS/ERRC, USA

11.1 Introduction

Much discussion has arisen over the possible benefits of organic food, including milk. Organic milk comes from cows that are managed using a certified organic system that includes significant amounts of pasture during the grazing season and would be expected to contain some compounds that are not found or are found at higher concentrations in animals from conventional farms, where grazing on fresh pasture may be limited. The nature of these compounds, and whether they may confer health benefits, is the subject of continuing research.

This chapter deals with the regulatory and legal issues concerning organic labelling, the bioactivity of the proteins, peptides, fatty acids, vitamins and minerals found in milk, as well as variations in these components due to feed and processing, trends, and research needs.

11.2 Regulatory Status

11.2.1 Organic and Conventional Dairies

For thousands of years, cows in herds and on small family farms were essentially organic and sustainable, feeding on available pastures and forages. During the twentieth century, extensive agricultural research focused on increasing milk yield and improving production efficiency. Advances in animal nutrition, genetics, and health, as well as improvements in farm management and mechanization, resulted in

the conventional dairy farms of today. Management trends may include high density animal housing and administration of antibiotics and hormones to stimulate milk production and maintain animal health. Feeds are produced under many different systems that may include the use of pesticides, synthetic fertilizers and genetically modified organisms. Animal diets are often formulated to a least-cost ration in which energy dense grain–protein supplements are used, with less emphasis on fresh forage, and cows may or may not have access to pasture. Some farms may graze their cows extensively on fresh pasture but because portion of the diet is not certified organic, the milk cannot be sold as organic.

The ‘organic’ label for foods was established by the US Department of Agriculture (USDA) under the Organic Foods Production Act of 1990 and the National Organic Program, Title 7 of the Code of Federal Regulations, Part 205 in 2000 (CFR, 2013). To receive the ‘organic’ label from a USDA-accredited certifying agent, the farming system must adhere to all regulations, whether they grow crops or maintain livestock. In the case of dairy producers, animals must be fed and managed according to approved organic practices for a full year before the milk that is produced can be certified and sold as organic. The animals must be given feed that is 100% organic, and must obtain a minimum average of 30% of their dry matter intake (DMI) from pasture during a minimum 120-day grazing season. Sick animals must be treated. If the medicine is not on the approved-for-organic list (CFR, 2013) the animal is no longer considered organic and must be removed from the herd. The use of growth hormones, antibiotics, genetic engineering and cloning is not allowed in organic systems. All feed and medicine given to the organic animals must be documented.

11.2.2 Nutritional claims

Milk and dairy food processors strategically use nutritional claims on the labels of their products to inform consumers of their nutritional value. The nutritional claims must comply with the regulations and industry standards developed by the Food and Drug Administration (FDA), the Federal Trade Commission (FTC), and other governing agencies (FDA, 2003, 2012; FTC, 1994). Nutritional claims for milk and dairy products are divided into three groups: nutrient content, health and structure/function (FDA, 2003, 2012). Extensive labelling regulations are in place for foods intended for human consumption (Title 21, CFR, 2013) that cover all points of nutritional claims from terminology that can be used to the size of font and placement of the statement on the label (FDA, 2012). A thorough review of the regulations covering nutritional claims for the dairy industry is available through the Dairy Research Institute (DRI, 2011).

Nutrient content claims Nutrient content claims (21 CFR 101.13, 101.54-101.69) found in the nutrition facts box on the label are based on the amount of the nutrient in the food (FDA, 2003, 2012) and include serving size, servings per container, total calories, calories from fat and a listing of nutrients in percentage of daily values, DV (based on a 2000 calorie/day diet). This DV list includes total fat, saturated fat, *trans* fat, cholesterol, sodium, total carbohydrates, sugars, dietary fibre, protein, vitamin A, vitamin C, calcium and iron. The reference amounts are used in calculating the values that go on the nutrition facts label and for determining if a food meets the required criteria for a nutrient claim or if a disclosure statement is needed (a nutrient is above limits set for total fat [13 g], saturated fat [4 g], cholesterol [60 mg] or sodium [480 mg]).

Terminology is strictly defined for nutrient claims. Absolute nutrient claims are for a specific nutrient in a specific food and are based on FDA established values for that nutrient; they do not make comparisons with other foods. Examples of absolute claims that are used for dairy foods include 'high in calcium', 'low in fat' and 'low in sodium'. Absolute claims also include 'excellent source of ...', 'high in ...' or 'rich in ...' for foods containing 20% more of a nutrient than the DV in a reference amount and 'good source of ...' when it contains 10–19% more than the DV. Milk meets the requirements to be labelled 'high in calcium and phosphorus' and a 'good source of protein', while most plain yogurts can claim 'high in calcium and phosphorus' and a 'good source of potassium' (DRI, 2011). Many types of cheese meet the requirements to use 'high in calcium' and a 'good source of protein and phosphorus'.

Relative nutrient claims are used when the level of a nutrient is compared between two foods with a minimum of a 10% difference in the DV found in the reference amount. Claims that use the descriptor 'more' can compare similar or dissimilar foods and must have the percentage difference and values for both foods stated on the label. Claims using 'less' or 'reduced' must have a 25% reduction of the specific nutrient in the DV value for the reference amount for similar foods and also require the percentage difference and values for both foods being compared. Claims using the 'fortified' or 'enriched' statements must be for the same food, such as enriched yogurt versus regular yogurt. Milk and yogurt containing less than 0.5% fat can be termed 'fat free' while milk, yogurt and cottage cheese containing less than 3 g fat per reference amount can be labelled 'low fat' (DRI, 2011). Total fat must be reduced by 25% in reference amount to be labelled 'reduced fat'. For the most part, fat-free and low-fat milk, yogurt and cottage cheese may qualify for the low-cholesterol claim.

An implied nutrient claim is approved on a case-by-case basis by the FDA because the claim implies health benefits when the following are used: presence or absence of a nutrient at a prescribed amount, the name of the product includes an ingredient associated with nutritional benefit or 'as much *nutrient* as *other food*' statement. The use of the term 'healthy' on the label implies low levels of total fat, saturated fat, cholesterol and sodium. 'Healthy' dairy foods must meet the requirements for low fat and low saturated fats, be below the limits for disclosure for cholesterol and sodium, and contain at least 10% of the DV for one or more of vitamin A, calcium, iron, protein or fibre. Often, fat-free milk, yogurt and low-fat cottage cheese may be eligible for the 'healthy' claim (DRI, 2011). The use of 'healthy' as a nutrient claim is not the same as a health claim.

Health Claims Health claims (21 CFR 101.4, 101.70-101.83) are used to relate a nutrient to reducing the risk of a disease or health-related condition (FDA, 2003, 2012) and must be substantiated with scientific evidence and receive authorization from the FDA. Key to approval is the significant scientific agreement standard (SSAS), where there is significant agreement among qualified experts that the publicly available evidence supports the relationship between the nutrient and the disease or health condition. Through the 1990 Nutrition Labeling and Education Act (FDA, 1990), the FDA is authorized to develop regulations for health claims for nutrients after conducting a thorough review of the scientific evidence and use of SSAS that show a well established relationship between the nutrient and the disease or health related condition. The 1997 FDA Modernization Act (FDA, 1997) allows health claims to be approved based on authoritative statements from the scientific body of the United States government or a federally approved organization, such as the National Academy of Sciences, National

Institute of Health or Centers for Disease Control and Prevention. Guidance on the FDA's process to review the scientific evidence required to support a health claim is available (FDA, 2009). The 2003 FDA Consumer Health Information for Better Nutrition Initiative allows the FDA to issue Qualified Health Claims when there is emerging research that strongly supports the nutrient/disease relationship but the evidence does not yet meet the SSAS criteria. The FDA carefully reviews the individual studies, evaluates the totality of the scientific evidence, assesses the SASS and reviews the specific language of the health claim before making the decision to approve or deny a request for a health claim. Once authorized, health claims are available to all food companies. The wording of the claim must be carefully tailored to state how intake/reduced intake may impact the disease or health-related condition in the framework of the total diet, all in an easy to understand and truthful manner. Claims must state that there are many factors that can impact the disease. Claims cannot quantify any potential reduction in risk and the food cannot be aimed at infants or toddlers under the age of two years.

The FDA has approved several health claims (21 CFR 101.72-101.83); five are pertinent to the dairy industry:

- (i) *'Adequate calcium (and vitamin D) throughout life, as part of a well-balanced diet, may reduce the risk of osteoporosis'* (21 CFR 101.72). This claim can be used for 0–2% fat milk and fat-free or low-fat plain yogurts that meet the requirements.
- (ii) *'Diets low in sodium may reduce the risk of high blood pressure, a disease associated with many factors'* and *'Development of hypertension or high blood pressure depends on many factors. [This product] can be a part of a low-sodium, low-salt diet that might reduce the risk of hypertension or high blood pressure'* (21 CFR 101.74). Milk containing 0–2% fat and low sodium (maximum of 140 mg of sodium per reference amount) can use these statements.
- (iii) *'Development of cancer depends on many factors. A diet low in total fat may reduce the risk of some cancers'* (21 CFR 101.73). Dairy products containing less than 3 g of total fat per reference amount, such as 0–1% fat milk, fat-free and low-fat plain yogurt, and fat-free cottage cheese, are eligible to use this claim.
- (iv) *'While many factors affect heart disease, diets low in saturated fat and cholesterol may reduce the risk of this disease'* (21 CFR 101.75). Only dairy products containing less than 1 g of saturated fat, 20 mg of cholesterol and 3 g total fat per reference amount and not more than 15% calories from fat such as milk, plain yogurt and cottage cheese are eligible to use this claim.
- (v) *'Diets containing foods that are a good source of potassium and that are low in sodium may reduce the risk of high blood pressure and stroke.'* (21 CFR 101.83). Non-fat milk, which is a good source of potassium and meets the requirement for low sodium and low fat and the other requirements, is the only dairy product eligible to use the health claim.

Structure/Function Claims The structure/function claims (21 CFR 101.93) describe the role of the nutrient on the structure or function of the body; they do not state or imply any connection to a disease or health condition (FDA, 2003, 2012). Structure/function claims do not have to be reviewed or approved by the FDA as long as the statements are truthful and not misleading and have 'credible and reliable'

scientific proof to support the claim. Examples of structure/function claims used on dairy foods include:

- ‘calcium builds strong bones’,
- ‘potassium helps maintain normal blood pressure’, and
- ‘vitamin A helps maintain normal vision’.

11.3 Bioactive Compounds in Milk

11.3.1 Peptides and Proteins

Bioactive milk peptides are becoming increasingly popular due to their potential use in health-promoting foods and as nutraceuticals aimed at combating various conditions that can be controlled through diet, such as cardiovascular disease, type II diabetes and obesity (Korhonen, 2009). There have been numerous studies establishing milk proteins as important sources of biologically active peptides (Tomita *et al.*, 1991; Meisel and Bockelmann, 1999; FitzGerald *et al.*, 2004; Séverin and Xia, 2005; Korhonen and Pihlanto, 2006; Hirota *et al.*, 2007; Hernandez-Ledesma *et al.*, 2008). The active peptides are embedded within the sequence of a parent protein and are hydrolytically released upon treatment with digestive enzymes, bacteria-associated proteases or other proteases (Korhonen and Pihlanto, 2006). The resulting peptides display a wide variety of *in vitro* biological activities, from immuno-modulating peptides to peptides with opioid activity to antioxidative and antihypertensive activities (Nagpal *et al.*, 2011), but generally have yet to be applied *in vivo*. Based on this broad spectrum of activities, there is great potential for the application of these active peptides in the numerous foods produced by the dairy industry.

Antihypertensive Peptides Hypertension, also known as high blood pressure, is a chronic condition that can lead to more severe and deadly illnesses like stroke and coronary heart disease. Angiotensin-converting enzyme (ACE) is a key component in one of the biological pathways that regulate blood pressure in the human body. Through a variety of mechanisms (Pihlanto *et al.*, 2010), ACE causes blood pressure to increase. Therefore, inhibiting the action of the ACE enzyme can lead to a decrease in blood pressure (Chen *et al.*, 2009). A number of studies have targeted the correlation between dairy consumption and lowering of blood pressure (Lopez-Fandino *et al.*, 2006; Jauhiainen and Korpela, 2007) and characterized specific milk protein-derived compounds from various dairy products with ACE-inhibitory activity (Korhonen and Pihlanto, 2006). Antihypertensive peptides are generally short sequences containing hydrophobic residues such as proline, tryptophan, tyrosine and phenylalanine for improved binding to ACE (Meisel, 1998; Foltz *et al.*, 2009). These active peptides are derived from the enzymatic degradation of milk proteins, mostly caseins, by gastrointestinal enzymes in the gut or by bacterial proteinases during milk fermentation (Pihlanto *et al.*, 2010). Hence, many ripened cheeses, such as Cheddar (Singh *et al.*, 1997) or aged Gouda (Saito *et al.*, 2000), are sources of bioactive compounds including antihypertensive peptides. Milk fermented using varieties of lactic acid bacteria has been shown to provide antihypertensive peptides derived from β -casein (Pihlanto *et al.*, 2010). Recently, protein extracts from Queso Fresco have also been reported to display antihypertensive properties (Paul and Van Hekken, 2011; Torres-Llanez *et al.*, 2011).

Well-known ACE inhibiting tripeptides VPP and IPP (Nakamura *et al.*, 1995a, 1995b) are resistant to proteolysis *in vivo*, suggesting that these compounds will have long, effective lifetimes within the body and will not be quickly degraded or inactivated. They have recently been tested in human hypertensive subjects and have improved central blood pressure and arterial stiffness (Nakamura *et al.*, 2011). The *in vivo* antihypertensive action of other novel casein-derived short peptides has also been demonstrated (Quiros *et al.*, 2007, 2012; del Mar Contreras *et al.*, 2009). The production of antihypertensive peptides from casein and β -lactoglobulin has been reported, too (Welderufael *et al.*, 2012). Numerous other reports of milk protein-derived antihypertensive peptides exist and have been reviewed extensively (Saito 2008; Nagpal *et al.*, 2011).

Antibacterial Peptides Many milk protein-derived peptides display antimicrobial activity. Among the earliest identified peptides are the α_{s2} -casein fragment casocidin-I (Zucht *et al.*, 1995), generated after treatment of α_{s2} -casein with pepsin, and the α_{s1} -casein fragment isracidin (Lahov and Regelson, 1996), obtained by pepsin or chymosin treatment of α_{s1} -casein; a number of reviews provide more detailed information on their identification, production, and efficacy against pathogenic and food spoilage bacteria (Korhonen and Pihlanto, 2006; Lopez-Esposito and Recio, 2008; Korhonen, 2009; Nagpal *et al.*, 2011). Briefly, casocidin-I has been shown to be more effective against Gram-positive bacteria, particularly *Streptococcus thermophilus*, while isracidin has displayed activity against *Staphylococcus aureus*, *Streptococcus pyogenes* and *Listeria monocytogenes*.

Antimicrobial components are not limited to casein-derived products. Proteolytic treatment of whey proteins also gives rise to the production of antimicrobial peptide fragments. Trypsin digests of α -lactalbumin (α -LA) produce peptide fragments with activity against Gram-positive bacteria such as *Bacillus subtilis* and *Staphylococcus epidermis* (Pellegrini, 2003). β -Lactoglobulin (β -LG) digested with trypsin also yields peptides that are active against a variety of microbial species (Pellegrini, 2003). Depending on individual sequence, the efficacy of these compounds can be altered. This is exemplified by anionic peptide fragments that are active against Gram-positive bacterial species and can be converted to more broadly acting agents against Gram-negative species through amino acid replacement.

Lactoferrin is a minor milk protein found in the whey fraction that has been shown to have broad spectrum activity against bacteria (Brock, 2012). The intact protein along with lactoferrin-derived peptide fragments known as lactoferricins have been effective against streptococci, *Escherichia coli*, as well as preventative against biofilm formation of *Pseudomonas aeruginosa* and oral pathogens. Lactoferrin is an iron-binding protein in milk with a diverse set of biological activities. Lactoferrin and peptides derived from it have demonstrated antimicrobial activity, antiviral activity against viruses like hepatitis, herpes and HIV (Valenti *et al.*, 1998; Valenti and Antonini, 2005), antifungal and antiparasitic activity (Legrand *et al.*, 2008), as well as anti-inflammatory activities (Legrand and Mazurier, 2010). Recently, a six-amino acid peptide fragment of lactoferrin, bLFcin(6), has been reported as a cell-penetrating peptide that may be useful as a drug delivery vehicle in the treatment of various illnesses (Fang *et al.*, 2012).

Other Peptides Peptides that bind the opiate receptor and can exhibit opiate-like activities (e.g. enkephalins and endorphins) are known as opioid peptides. Some milk

protein-derived opioid peptides have been reported, including: the β -casomorphins that are derived from β -casein and behave like opioid receptor agonists (Teschemacher *et al.*, 1997); the α -casein derived exorphins that are opioid receptor antagonists (Teschemacher *et al.*, 1997); the κ -casein derivatives, including casoxin D (Teschemacher *et al.*, 1997); and the lactoferrin-derived lactoferroxins (Nagpal *et al.*, 2011), which are also opioid antagonists. Opioid-like peptides have been derived from whey proteins, as well. The α - and β -lactorphins are derived from α -LA and β -LG, respectively, and along with their opioid-like activities display antihypertensive activity as well (Sipola *et al.*, 2002).

Glycomacropeptide (GMP) is derived from chymosin treatment of κ -casein and has a number of biological applications associated with it, including antibacterial and antithrombotic activities (Zimecki and Kruzel, 2007). The sequence of GMP does not contain any aromatic amino acids, allowing for its utility in the diets of patients suffering from phenylketonuria, a condition caused by the inability to metabolize the aromatic amino acid phenylalanine (Nagpal *et al.*, 2011).

Other milk-protein derived peptides include the casein phosphopeptides, which have found clinical use in the treatment of dental caries and have potential application in oral care and other dental products (Cross *et al.*, 2007). Novel activities and potential uses for bioactive peptides from milk products are regularly reported, including publications describing a benzodiazepine-like peptide derived from bovine casein known as α -casozepine that may be useful in the treatment of anxiety disorders (Cakir-Kiefer *et al.*, 2011a, 2011b). In the majority of these cases, the actual utility of these peptides remains unknown, and a full understanding of bioavailability and efficacy of these compounds *in vivo* will hopefully yield commercially useful peptides in the future.

11.3.2 Fatty Acids

Approximately half of bovine milk fat is synthesized from plasma lipids, of which 88% come from the diet of the cow (Grummer, 1991). Dietary changes will, therefore, significantly affect milk fat composition. Raw milk contains 3.5–5% fat, depending on the breed. Milk processors usually standardize the percentages of fat in their products to 3.25 (labelled as whole milk), 2.0, 1.0, or 0.1 (skimmed or nonfat). Although milk fat has become associated with harmful health effects in recent years, it also has positive attributes that only now are receiving publicity.

Milk fat molecules mostly consist of three fatty acids (FAs) attached to a glycerol backbone, forming a triacylglycerol. Short- and medium-chain FAs (with fewer than 12 carbon atoms) are absorbed from the intestine, transferred into the liver and metabolized quickly through β -oxidation. The longer-chain FAs are reconverted into triacylglycerols, which are stored in adipose tissue or consumed as fuel (Parodi, 2006). About one-third of the FAs in milk fat contain 14 carbon atoms or less, an indication that milk fat may not be as much of a factor in fat storage and obesity as other fats containing a higher percentage of long-chain FAs. Moreover, the short- and medium-chain FAs have possible health benefits: butyric acid (4:0) modulates gene function and may play a role in cancer prevention; caprylic acid (8:0) and capric acid (10:0) have demonstrated antiviral activity; caprylic acid has also been reported to delay tumour growth; and lauric acid (12:0) could have antiviral, antibacterial anticaries and antiplaque activity (Claeys *et al.*, 2013).

Saturated fatty acids (SFAs) have no double bonds in the carbon chain, monounsaturated fatty acids (MFAs) have one and polyunsaturated fatty acids (PUFAs) have two or three. Although SFAs have long been implicated in elevation of plasma cholesterol, only lauric (12:0), myristic (14:0) and palmitic (16:0) acids appear to possess hypercholesterolemic properties (Grummer, 1991; Mensink *et al.*, 2003).

According to the National Academy of Sciences, 'conjugated linoleic acid (CLA) is the only fatty acid shown unequivocally to inhibit carcinogenesis in experimental animals' (National Academy of Sciences, 1996). CLA is a mixture of isomers of linoleic acid (18:2); rumenic acid (*cis*-9, *trans*-11 18:2), the predominant isomer, is thought to be the biologically active form (Ip *et al.*, 1994). The CLA content in milk fat ranges from 0.1 to 2.0%. Dairy products are the major sources of CLA in the human diet and its concentration in these products is not affected by processing (Lin *et al.*, 1995) but is affected by the total amount of fat in the milk, that is skimmed milk contains significantly less CLA than whole milk (3.25% fat).

Trans FAs have been implicated in increases in LDL ('bad') cholesterol and decreases in HDL ('good') cholesterol. These effects have been tied to the *trans* FAs in hydrogenated fats, predominately elaidic acid (*trans*-9 18:1). Elaidic acid is present in only trace amounts in bovine milk. One-quarter of the *trans* FAs in milk fat is rumenic acid and most of the rest is vaccenic acid (*trans*-11 18:1) (Parodi, 2006). Rumenic acid may be associated with anticarcinogenic properties in humans (Elgersma *et al.*, 2006) and vaccenic acid may decrease tumour growth and the risk of coronary heart disease (Field *et al.*, 2009). On average, humans convert about one-fifth of dietary vaccenic acid into rumenic acid (Turpeinen *et al.*, 2002).

11.3.3 Vitamins and Minerals

The vitamins and minerals found in milk are present in small amounts (Table 11.1) and are known to be essential for proper functioning of the body. The vitamins detected in milk are classified as fat soluble (A, D, E and K) and water soluble (the B complexes). The minerals found in milk are classified as macro elements (calcium, chloride, magnesium, potassium, phosphorus and sodium) and trace elements (arsenic, boron, chromium, cobalt, copper, fluoride, iodine, iron, manganese, molybdenum, nickel, selenium, silicon and zinc).

Fat-Soluble Vitamins The level of vitamins in milk is influenced by the cow's health, stage of lactation, genetics and diet. The concentration of the fat-soluble vitamins in dairy products is further dependent on the level of fat in the product; therefore, butter, ice cream and cheese will contain higher levels of fat-soluble vitamins than milk. Whole milk is considered a good source of vitamin A and a fair source of vitamin D; the dairy industry typically fortifies milk to make it an excellent source of vitamin A and D, especially in lower fat milk (DPC, 2001). Milk is not considered a good source of vitamin E and K although fermented dairy products, such as yogurt and cheese, may contain slightly higher levels of vitamin K than whole milk (Elder *et al.*, 2006).

Vitamin A consists of several fat-soluble retinoids that function in growth and development, immunity and vision (Ross, 2010). Milk is a good source of the precursor of vitamin A, retinol and retinyl ester, and, in some bovine breeds such as the Guernsey, the provitamin A carotenoid, β -carotene (NIH, 2012). The precursor and provitamin compounds are converted within the body's cells to the active forms of vitamin A,

Table 11.1 Levels of vitamins and minerals found in whole (3.25% fat) bovine milk, not fortified with vitamins A and D (Cashman, 2003a, 2003b; USDA, 2012). Quantity is given as the amount of the vitamin or mineral in milk and does not reflect the actual dietary requirements

Vitamins	Quantity (mg/100 g milk)	Minerals	Quantity (mg/100 ml milk)
Fat soluble		Macro elements	
A*	0.046	Calcium**	113
Carotene, β	0.007	Chloride	97
Retinol	0.045	Magnesium	10
D*	0.0001	Phosphorus**	84
E	0.07	Potassium*	132
K	0.0003	Sodium	43
Water soluble		Trace elements	
B Vitamins		Arsenic	<0.01
B1, Thiamin	0.046	Boron	<0.01
B2, Riboflavin**	0.169	Chromium	<0.01
B3, Niacin*	0.089	Cobalt	<0.01
B5, Pantothenic acid	0.373	Copper	0.025
B6, Pyridoxine, pyridoxal	0.036	Fluoride	<0.01
B7, Biotin	0.003	Iodine	0.01
B9, Folate*	0.005	Iron	0.03
B12, Cobalamins**	0.00045	Manganese	<0.01
		Molybdenum	<0.01
		Nickel	<0.01
		Selenium	3.7
		Silicon	<0.02
		Zinc	0.37

*Whole milk is a good or fair source of this compound

**Whole milk is an excellent source of this compound

retinal and retinoic acid. Vitamin A is essential in maintaining eye health, as it functions in the cornea, retinal receptors and conjunctive membranes. It contributes to regulating cell growth and differentiation, which is important in maintaining critical organs, such as the heart, lungs, kidneys and skin (Ross, 2010). Vitamin A is also important in bone growth, reproduction and immunity.

The fat-soluble vitamin D found in milk is cholecalciferol (vitamin D₃) or its metabolite 25-hydroxyvitamin D; both are inert until converted in the kidney to 1,25-dihydroxyvitamin D, the most active form of the vitamin (Institute of Medicine, 2010). Vitamin D is critical in promoting calcium absorption, maintaining serum calcium levels, bone and dental growth, and bone density (Holick, 2004; Institute of Medicine, 2010). Vitamin D primarily works through regulating gene transcription in tissue throughout the body, thereby influencing the nervous system, cell growth, insulin secretion and immune function. Research shows that vitamin D functions in preventing osteoporosis (Heaney, 2003) and rickets (Wharton and Bishop, 2003), and may decrease the risk of hypertension (Pfeifer *et al.*, 2001) and cardiovascular disease (Bauman *et al.*, 2006). Vitamin D may have a role in limiting autoimmune diseases such as type 1 diabetes (Holick, 2004), multiple sclerosis (Munger *et al.*, 2004, 2006) and rheumatoid arthritis (Merlino *et al.*, 2004). The role of vitamin D in

decreasing the risk of cancer is still to be determined although it has been found to inhibit cancer growth and promotes cell differentiation *in vitro* (Blutt and Weigel, 1999) and promising results have been reported for colorectal, breast and prostate cancers (Holick, 2004).

The fat-soluble vitamin E is a collection of tocopherols and tocotrienols that function primarily as antioxidants but only the α -tocopherol is actively retained in the human body (Traber, 2006). As an antioxidant, vitamin E intercepts free radicals formed in the body during normal metabolism or when under stress that damage cells by oxidizing compounds, especially the lipids found in cell membranes. Although some studies suggest that vitamin E may reduce the risk of coronary heart disease and cancer (Institute of Medicine, 2000; Glynn *et al.*, 2007), there is insufficient clinical proof to support these views. Some studies suggest that vision disorders in which oxidative stress may play a role, such as age-related macular degeneration and cataracts, may be delayed by vitamin E (Chong *et al.*, 2007; Evans, 2007), usually when partnered with other antioxidants, such as zinc and copper (AREDS, 2001).

The fat-soluble vitamin K is found in two forms: phyloquinone, vitamin K₁, from plants, and menaquinones, vitamin K₂, from animal/microbial sources. The menaquinones (MK-*n*, *n* = 2–15) are identified by the number of repeating isoprene (C5) units in their side chains. Vitamin K₁ and MK-4 have been reported in milk (Elder *et al.*, 2006) while MK-5 to MK-9 have been found in fermented milk and dairy products (Koivu-Tikkanen *et al.*, 2000). As a cofactor, vitamin K is critical to the γ -carboxylation of glutamic acid residues on specific vitamin K-dependent proteins, controlling the calcium-binding function (Shearer, 1997; Ferland, 2006) and impacts blood coagulation, bone metabolism, cellular growth and haemostasis (Koivu-Tikkanen *et al.*, 2000; Ferland, 2006).

Water-Soluble Vitamins Water-soluble vitamins are not stored in the body and must be supplied daily in the diet. Milk is an excellent source of B₁₂ and B₂, a fair source of B₁, B₅ and B₉, and a poor source of B₃, B₆ and B₇ (USDA, 2012). The B vitamins function primarily as coenzymes involved in many different energy metabolism pathways and single carbon unit transfer processes (Institute of Medicine, 1998).

The water-soluble Vitamin B₁₂ is a family of cobalt-containing compounds known as cobalamins (Institute of Medicine, 1998). Vitamin B₁₂ is a coenzyme that functions in pathways critical to forming red blood cells, maintaining the nervous system, synthesizing DNA and metabolizing lipids and proteins. Vitamins B₁₂, B₆ and B₉ contribute to the metabolism of homocysteine (Clarke, 2008) and have been linked to reducing the risk of stroke (Lonn *et al.*, 2006). These vitamins have potential to reduce the risk of heart diseases (Lichtenstein *et al.*, 2006) or dementia (Balk *et al.*, 2007); however, more research is needed.

Vitamin B₂ or riboflavin is an essential part of the coenzymes that function in the oxidation–reduction (redox) reactions in several key metabolic pathways. Vitamin B₂ is important in the metabolism of carbohydrates, proteins and lipids to provide energy to the body (McCormick, 2006) and is also essential in the metabolism of vitamins B₃, B₆ and folic acid.

Thiamin, also known as vitamin B₁, contains sulfur and is found in the body in a free or phosphorylated form (thiamin mono-, tri-, or pyro-phosphate). Thiamin pyrophosphate is an essential coenzyme in the metabolism of carbohydrates and amino acids,

maintenance of cardiovascular, gastrointestinal, nervous and muscular systems (Rindi, 1996), and the synthesis of DNA and RNA (Brody, 1999).

Pantothenic acid, also known as vitamin B₅, is an integral part of coenzyme A and is essential in many reactions in the cells (Trumbo, 2006). Coenzyme A is required to produce energy from carbohydrates, proteins and lipids, as well as in the synthesis of cholesterol, hormones, neurotransmitters and haem (Brody, 1999). The phosphopantetheine form of pantothenic acid is essential in the metabolism of fatty acids (Institute of Medicine, 1998).

Vitamin B₉ is found in milk in the form of folate (Institute of Medicine, 1998). As a coenzyme, folates participate in the transfer of one carbon unit in the metabolism of amino acids and nucleic acids (Bailey and Gregory, 1999). Folates, along with vitamins B₁₂ and B₆, are required in the metabolism of homocysteine (Clark, 2008). These vitamins may play a role in reducing the risk of heart disease (Lichtenstein *et al.*, 2006), cancer (Bailey and Gregory, 1999) or dementia (Balk *et al.*, 2007), although more evidence is needed.

Macro Minerals Milk provides all 20 of the essential elements required by humans in a wide range of concentrations (Table 11.1) and gives milk an excellent buffering capacity. Although the amount of minerals in milk can vary based on the animal's health, stage of lactation, genetics and diet, the macro minerals (calcium, chloride, magnesium, phosphorus, potassium and sodium) are usually found in mg/100 ml milk amounts. The trace elements copper, iodine, iron, selenium and zinc are usually found in µg/100 ml milk (Cashman, 2003a). Milk is a poor source of the trace elements arsenic, boron, chromium, cobalt, fluoride, manganese, molybdenum, nickel and silicon.

The macro mineral calcium is the most identifiable mineral in milk with 66% associated with milk proteins and, with phosphates, stabilizes the proteins in micelle formations. The remaining calcium is in a soluble form, as either calcium citrate or free ions (Cashman, 2003a). Once in the body, about 99% of the calcium is bound to phosphate to form hydroxyapatite, the structural component of bone and teeth. About 1% of the calcium in the human body is found in blood and extracellular fluid, which is essential to maintain body functions, including blood vessel constriction/dilation, nerve impulses, muscle contraction and secretion of hormones (Institute of Medicine, 1997). Insufficient dietary calcium to maintain requisite levels in body fluids will lead to bone demineralization (Weaver and Heaney, 2006). Calcium also acts as a cofactor, stabilizing and activating many critical proteins and enzymes within the body. Calcium is linked to reducing the risk of osteoporosis (Heaney, 2000), colorectal cancer (Baron *et al.*, 1999; Bostick, 2001) and hypertension (Appel *et al.*, 1997; Miller *et al.*, 2000), as well as aiding in weight loss (Davies *et al.*, 2000; Lin *et al.*, 2000).

Another macro mineral in milk is phosphorus, in the form of phosphates. Approximately 20% of phosphates are bound to serine residues in the caseins, 35% stabilize casein micelles while bound to calcium and the remaining phosphates are soluble as free ions. Phosphorus is essential to many of the biological molecules in the body, including proteins, carbohydrates, lipids and nucleic acids (Cashman, 2003a). Phosphates are critical in calcium and protein metabolism bone, teeth and cell membrane structure, and in maintaining body pH (Knochel, 2006). While high phosphate levels in the blood can impact absorption and excretion of calcium, extremely low

phosphate levels have been linked to anaemia, muscle and bone weakness and rickets (Institute of Medicine, 1997).

The macro mineral potassium is found mainly as free ions in milk. In the body, potassium is found in all fluids and is the major intracellular cation, critical for forming the membrane potential. It is a cofactor for several key enzymes, such as ATPase and pyruvate kinase. Potassium contributes to fluid balance, muscle function, neurotransmissions, heart function and blood pressure maintenance (Sheng, 2000; Cashman, 2003a). High potassium intake has been linked to reducing the risk of stroke (Larsson *et al.*, 2008), hypertension (Whelton *et al.*, 1997) and osteoporosis (Zhu *et al.*, 2009).

Sodium is also found in milk, mainly as free ions. Although milk contains sodium, many dairy products contain higher sodium levels due to salt added during processing and manufacturing. Sodium is the major extracellular cation, critical for forming the membrane potential and has many functions within the body, including regulation of the extracellular fluid volume, osmolality and pH balance, as well as being essential to muscle and heart function, and neurotransmissions (Sheng, 2000; Cashman 2003a). Excessive sodium serum levels have been linked to hypertension, heart disease and stroke (Elliott *et al.*, 1996; Whelton *et al.*, 1997; Cook *et al.*, 2007). The excessive intake of sodium in the American diet has resulted in many nutritional institutions calling for a reduction of sodium (Institute of Medicine, 2004; Gunn *et al.*, 2013).

The macro mineral magnesium is found in milk in soluble forms such as magnesium citrate and magnesium phosphate, or as free ions, with the majority of it associated with calcium and phosphate in the casein micelle. Within the body, this mineral functions as a cofactor for many enzymes and is essential for protein and nucleic acid metabolism, nerve and muscle function, bone growth and maintenance, and maintaining blood pressure (Miller *et al.*, 2000; Cashman, 2003a). Low serum levels of magnesium have been associated with diabetes and migraine headaches (Wang *et al.*, 2003). Although several studies have shown that increased magnesium intake decreases blood pressure (Ascherio *et al.*, 1992, 1996) and increased magnesium and potassium levels increase bone density (Tucker *et al.*, 1999), its effectiveness in reducing the risk of hypertension, heart disease and osteoporosis is still unclear.

Chloride is found in the free ion form in milk. In the body, it is the major extracellular anion and is essential for maintaining the balance of electrolytes and fluids (Cashman, 2003a).

Micro Minerals Milk and dairy products are considered good sources of iodine. Within the body, iodine is incorporated into thyroid hormones and thus helps in maintaining the rate of body metabolism and in reproduction (Cashman, 2003a).

The iron in milk is usually bound to the glycoprotein lactoferrin (Cashman, 2003a). Within the body, iron is an essential part of many compounds in the oxygen transport and storage system and functions as a cofactor for many enzymes (Cashman, 2003a).

Selenium is also found in milk and is essential to activate enzymes known as selenoproteins, which function in the immune system, antioxidant defences and hormone regulation (Gladyshev, 2006).

An additional element found in milk is zinc. In the body, zinc is an essential part of insulin as well as the many enzymes that are needed for growth, healing, immune responses and reproduction (Cashman, 2003a; Cousins, 2006). Zinc also contributes to the structure of cell membranes and proteins (O'Dell, 2000; King and Cousins, 2006).

11.4 Variations in Biologically Active Compounds

11.4.1 Pasture, Organic and Conventional Milk

As defined earlier in this chapter, certified organic dairy herds of today must provide an average of 30% of DMI from pasture during a minimum 120-day grazing season and all feeds must be certified organic. However, there is tremendous variation in feeding regimens among the individual organic farms, from the inclusion of fermented feeds such as corn silage, different levels and types of grain supplements, to exclusively grass fed (Sato *et al.*, 2005; Haas *et al.*, 2007; Weller and Bowling, 2007; Griswold *et al.*, 2008a). Grass-fed dairy herds can be conventional or organic but obtain 100% of their feed from pasture and forage, with no grain supplements. Very limited research data are available on 100% grass-fed dairy herds. Few papers comparing composition of milk from conventional and organic farm management have been published in the primary literature.

Reports on the effects of organic or pasture feeding on the lipid profile of milk are often contradictory. In an English study, organic milk had a higher proportion of PUFAs to MUFAs compared with conventional milk (Ellis *et al.*, 2006), whereas in a Swedish study, no difference was found (Toledo *et al.*, 2002). MUFAs are usually more desirable in conventional food products. A French study found that the level of 18-carbon FAs was significantly higher in milk from pasture-fed cows; FAs with fewer carbons were found at significantly higher amounts in conventionally fed cows (Couvreur *et al.*, 2007). In contrast, Ellis *et al.* (2006) and Toledo *et al.* (2002) studies found no difference in CLA between organic and conventional milk. Higher levels of linolenic acid (18:3) were found in organic milk, which was attributed to more extensive grazing on clover (Ellis *et al.*, 2006). Most recently, significant differences in fatty acids were reported in a large scale study of conventional and organic milk by Benbrook *et al.* (2013), who found that CLA was 18% higher in organic milk and concluded that pasture- and forage-based feed on dairy farms have considerable potential to improve the fatty acid profile of milk and dairy products.

Vaccenic acid production in the cow increases with altitude because the plants on which the cows are feeding are richer in PUFAs. PUFAs in the *cis* isomeric form are subsequently converted to the thermodynamically more stable *trans* isomers that can be identified in the resulting milk (Collomb *et al.*, 2001). Although one study found five times more vaccenic acid in pasture-fed cows than in conventionally-fed animals (Couvreur *et al.*, 2007) another study observed no difference in *trans* FAs in milk from organic and conventional farms (Toledo *et al.*, 2002).

11.4.2 Pasteurization and Homogenization

Milk sold in stores in the United States is homogenized and pasteurized. Milk is normally pasteurized at 71.7°C for 15 seconds (high temperature, short time) or at 138°C for two seconds (ultra high temperature, UHT). Pasteurization reduces the concentration of vitamin C by 35% (Lindmark-Månsson and Åkesson, 2000) and does not affect the amount of CLA, which is heat stable. Nearly all bacteria and enzymes are inactivated by pasteurization, including those that might confer health benefits; many scientists believe these benefits are largely outweighed by the

reduction in pathogen-related illness from nonpasteurized milk (Oliver *et al.*, 2009; Claeys *et al.*, 2013). No differences due to pasteurization in levels of vitamins (aside from C), minerals, fatty acids, peptides and proteins are expected among pasture, organic and conventional milk.

Fat in milk exists as globules with a protective outer layer known as the milk fat globule membrane (MFGM). The globules will aggregate in untreated cow's milk and form a cream layer. During homogenization, milk is forced through small orifices, typically at a pressure of 8–20 MPa, reducing the globule size from an average of 3–5 μm to $<1 \mu\text{m}$ (Michalski and Januel, 2006). The process strips off the MFGM and, thereby, prevents creaming by causing casein micelles and whey proteins to be adsorbed on the globule. The MFGM consists of cholesterol, enzymes, glycoproteins and other proteins, phospholipids and vitamins. The desorbed membrane fragments may provide health benefits such as anticholesterolemic effects from phospholipids, prevention of gastric diseases from some glycoproteins and anticancer effects from certain absorbed peptides and phospholipids such as sphingomyelin (Spitsberg, 2005). Any increase in fat content due to the diet of the cow would raise the amount of MFGM material in the milk and enhance the concentration of beneficial compounds.

11.4.3 Feed Changes

Because biologically active compounds BACs or their precursors must be present in the animal diet to increase their presence in milk, current research is looking for ways to naturally increase BACs in milk. While humans consume the milk and milk products from many different animals including goat, sheep, buffalo, yak and horse, the focus of this chapter is bovine milk.

It is well documented that the type of animal diet has dramatic effects on milk yield and composition (Bargo *et al.*, 2003; Schroeder *et al.*, 2003; Griswold *et al.*, 2008a, 2008b; Khanal *et al.*, 2008). Unlike earlier studies that simply reported the overall composition of milk, current research is more closely evaluating the individual components that comprise the fat, protein and solids portions of milk. The primary challenge is determining the quantity and quality of the pasture that affect the levels of beneficial compounds. While conventional farms may or may not incorporate grazing for their milking herds, certified organic United States farms must document the incorporation of a 30% average DMI from pasture for a minimum of 120 days for their milking herd. It is also important to study the changes in BAC concentrations in milk from organic farms throughout the year, especially through seasonal transitions in feeding practice (Butler *et al.*, 2011).

Research indicates that compounds such as CLA, β -carotene and vitamins A and E are elevated in milk from grass-fed cows (Dhiman *et al.*, 2000; Martin *et al.*, 2002; Bergamo *et al.*, 2003; Schoeder *et al.*, 2003; Couvreur *et al.*, 2006; Ellis *et al.*, 2006; Nozière *et al.*, 2006; Agabriel *et al.*, 2007; Chillard *et al.*, 2007; Ferlay *et al.*, 2008). One United Kingdom study reported that organic milk from cows fed diets high in clover contained 64% more omega-3 FAs than milk from conventional herds (Dewhurst *et al.*, 2003). Another United Kingdom study concluded that retail organic milk had 24% more PUFA, 32% more CLA and 57% more linolenic acid than milk from conventional dairies (Butler *et al.*, 2011). A recent review of the literature found that of the 10 beneficial compounds typically measured in animal products (milk, eggs and meat), only the *trans* fats, PUFAs and unspecified FAs were higher in organic products (Dangour *et al.*, 2009), while other studies have found no differences in levels of beneficial compounds in milk from organic or conventional herds (Toledo *et al.*, 2002).

CLA in milk is influenced by feeding, age of the animals and season (Collomb *et al.*, 2001). However, the most significant increase in CLA in milk occurs when cows graze on pasture. Cows grazing on lush green pastures at high daily herbage allowance will produce milk fat with the highest levels of CLA (Roca Fernandez and Gonzalez Rodriguez, 2012). The concentration of CLA in milk fat increases when cows are switched from total mixed diet to pasture (Kelly *et al.*, 1998), and increases linearly with the amount of pasture plants eaten (Dhiman *et al.*, 2000; Stockdale *et al.*, 2003). Dhiman *et al.* (2000) found that grazing cows had five times more CLA in their milk fat than cows fed typical dairy diets and Couvreur *et al.* (2007) found 3.3 times more. The CLA concentration in milk fat did not vary by breed in comparisons of Holsteins and Jerseys (White *et al.*, 2001) and of Holsteins and Brown Swiss (Kelsey *et al.*, 2003). Stanton *et al.* (1997) found no difference in CLA due to stage of lactation but did observe a 65% increase among pasture-fed cows when their diet was supplemented with full-fat rapeseed. CLA production is more pronounced in the Alps, where grasses are replaced by herbs as the altitude increases (Collomb *et al.*, 2001, Kraft *et al.*, 2003).

Concentrations of naturally occurring BACs may be increased through diet, selection of animal breeds and careful processing. Fortification of milk with BACs, such as the addition of fish oil to increase CLA levels, is another option that has a different set of problems associated with it and is not be discussed here. It is unlikely that milk can be a sole source of some BACs in a human diet. Instead, optimizing the amount of BACs in milk should be viewed as adding to the total BACs in a balanced diet.

11.5 The Future

11.5.1 Trends

Because of the health benefits associated with dairy foods and bioactive components of milk, fortifying foods with dairy-derived ingredients is becoming popular in food manufacturing to increase overall health benefits (Ward, 2012). In many cases, consumers are looking for foods with increased protein content to address diet concerns, and formulators are including vegetable and grain-derived proteins with milk proteins in a variety of food products to attract buyers.

Many fortified dairy foods are also gaining popularity with American consumers. Greek-style yogurt and fortified frozen yogurt, both with increased protein content, have shown increased sales over the past few years. These types of low-fat, high-protein alternatives to other similar types of food products may be fortified with various milk protein concentrates formulated specifically for these types of applications (Ward, 2012).

There have been some processing challenges in the incorporation of the fortified components, leading to various new technologies, including methods to deliver specific amino acid combinations in a soluble form for use in beverage manufacture, and developments that allow the fortification of chocolate coatings with protein (Ward, 2012).

In one study, UHT pasteurized omega-3 fatty acids have been incorporated into dairy beverages to make oxidatively stable products with an extended shelf life (Moore *et al.*, 2012). There are companies whose primary goal is to formulate ingredients for use as supplements in various foods, including milk and dairy products. One firm supplements milk with products based on fish oil, resveratrol and green tea extract (DSM, nd).

A variety of commercially available milk products is now marketed toward children, including whole milk fortified with iron to encourage healthy growth and development, and prebiotics to aid in digestion, as well as milk fortified with omega-3 fatty acids and fibre, fortified with vitamins A, D and C, that does not require refrigeration and can be incorporated in packed school lunches (Richman, 2012). A survey of UHT milk trends during the years between 2005 and 2008 found numerous companies focusing on fortifying milk products, including vitamin/mineral fortification geared at adult and children populations, heart health claims supported by incorporation of omega-3 and sterols, increased calcium content and ingredients geared at female consumers, including collagen, folate, iodine and choline.

11.5.2 Goals and Research Needs

The ultimate goal is to provide the consumer with a product that is concentrated with BACs, hopefully at pharmacological levels that will result in health benefits. Further studies are required to determine the differences between conventional and organic milk. Results thus far have indicated that pasture-fed cows may produce milk that confers added benefits to the consumer. More research is needed in animal and human nutrition, food science and technology, human nutrition, animal and human testing, and human wellness and diseases. Eventually, a complete picture of how various factors affect milk components will emerge.

Disclaimer

Mention of trade names or commercial products in this article is solely for the purpose of providing specific information and does not imply recommendation or endorsement by the US Department of Agriculture. USDA is an equal opportunity provider and employer.

References

- Agabriel, C., Cornu, A., Journal, C. *et al.* (2007) Tanker milk variability according to farm feeding practices: Vitamins A and E, carotenoids, color, and terpenoids, *Journal of Dairy Science*, **90**: 4884–4896.
- AREDS (Age-Related Eye Disease Study Research Group) (2001) A randomized, placebo-controlled, clinical trial of high-dose supplementation with vitamins C and E, beta carotene, and zinc for age-related macular degeneration and vision loss. AREDS report No 8, *Archives of Ophthalmology*, **119**: 1414–1436.
- Appel, L.J., Moore, T.J., Obarzanek, E. *et al.* (1997) A clinical trial of the effects of dietary patterns on blood pressure. DASH Collaborative Research Group, *New England Journal of Medicine*, **336**: 1117–1124.
- Ascherio, A., Rimm, E.B., Giovannucci, E.L. *et al.* (1992) A prospective study of nutritional factors and hypertension among US men, *Circulation*, **86**: 1475–1484.
- Ascherio, A., Hennekens, C., Willett, W.C. *et al.* (1996) Prospective study of nutritional factors, blood pressure, and hypertension among US women, *Hypertension*, **27**: 1065–1072.

- Bailey, L.B. and Gregory, J.F. (1999) Folate metabolism and requirements, *Journal of Nutrition*, **129**: 779–782.
- Balk, E.M., Raman, G., Tatsioni, A. *et al.* (2007) Vitamin B₆, B₁₂, and folic acid supplementation and cognitive function: a systematic review of randomized trials, *Archives of Internal Medicine*, **167**: 21–30.
- Bargo, F., Muller, L.D. Kolver, E.S. and Delahoy, J.E. (2003) Invited review: Production and digestion of supplemented dairy cows on pasture, *Journal of Dairy Science*, **86**: 1–42.
- Baron, J.A., Beach, M., Mandel, J.S. *et al.* (1999) Calcium supplements and colorectal adenomas. Polyp Prevention Study Group, *Annals of the New York Academy of Science* **889**: 138–145.
- Bauman, D.E., Mather, I.H., Wall, R.J. and Lock, A.L. (2006) Major advances associated with the biosynthesis of milk, *Journal of Dairy Science*, **89**: 1235–1243.
- Benbrook, C.M., Butler, G., Latif, M.A. *et al.* (2013) Organic production enhances milk nutritional quality by shifting fatty acid composition: a United States-wide, 18-month study, *PLOS One*, **8**(12): e82429.
- Bergamo, P., Fedele, E., Iannibelli, L. and Marzillo, G. (2003) Fat-soluble vitamin contents and fatty acid composition in organic and conventional Italian dairy products, *Food Chemistry*, **82**: 625–631.
- Blutt, S.E. and Weigel, N.L. (1999) Vitamin D and prostate cancer, *Proceedings of the Society for Experimental Biology and Medicine*, **22**: 89–98.
- Bostick, R. (2001) Diet and nutrition in the prevention of colon cancer, in *Preventive Nutrition: The Comprehensive Guide for Health Professionals*, 2nd edn (eds A. Bendich and R.J. Deckelbaum). Humana Press, Totowa, NJ, pp. 57–95.
- Brock, J.H. (2012) Lactoferrin – 50 years on, *Biochemistry and Cell Biology*, **90**: 245–251.
- Brody, T. (1999) *Nutritional Biochemistry*, 2nd edn. Academic Press, San Diego, CA.
- Butler, G., Stergiadis, S., Seal, C. *et al.* (2011) Fat composition of organic and conventional retail milk in northeast England, *Journal of Dairy Science*, **94**: 24–36.
- Cakir-Kiefer, C., Le Roux, Y., Balandras, F. *et al.* (2011a) *In vitro* digestibility of α -casozepine, a benzodiazepine-like peptide from bovine casein, and biological activity of its main proteolytic fragment, *Journal of Agricultural and Food Chemistry*, **59**: 4464–4472.
- Cakir-Kiefer, C., Miclo, L., Balandras, F. *et al.* (2011b) Transport across Caco-2 cell monolayer and sensitivity to hydrolysis of two anxiolytic peptides from α _{s1}-casein, α -casozepine, and α _{s1}-casein-f91-97: effect of bile salts, *Journal of Agricultural and Food Chemistry*, **59**: 11956–11965.
- Cashman, K.D. (2003a) Minerals in dairy products, in *Encyclopedia of Dairy Science* (eds H. Roginski, J.W. Fuquay and P.F. Fox). Academic Press, San Diego, CA, pp. 2051–2065.
- Cashman, K.D. (2003b) Vitamins, in *Encyclopedia of Dairy Science* (eds H. Roginski, J.W. Fuquay and P.F. Fox). Academic Press, San Diego, CA, pp. 2653–2726.
- CFR (2013) Code of Federal Regulations (Annual Edition). Available at <http://www.gpo.gov/fdsys/browse/collectionCfr.action?collectionCode=CFR> (last accessed 11 January 2015).
- Chen, Z.Y., Peng, C., Jiao, R. *et al.* (2009) Anti-hypertensive nutraceuticals and functional foods, *Journal of Agricultural and Food Chemistry*, **57**: 4485–4499.
- Chillard, Y., Glasser, F., Ferlay, A. *et al.* (2007) Diet, rumen biohydrogenation and nutritional quality of cow and goat milk fat, *European Journal of Lipid Science and Technology*, **109**: 828–855.

- Chong, E.W.-T., Wong, T.Y., Dreis, A.J. and Guymer, R.H. (2007) Dietary antioxidants and primary prevention of age-related macular degeneration: Systematic review and meta-analysis, *British Medical Journal*, **335**: 755.
- Claeys, W.L., Cardoen, S., Daube, G. *et al.* (2013) Raw or heated cow milk consumption: Review of risks and benefits, *Food Control*, **31**: 251–262.
- Clarke, R. (2008) B-vitamins and prevention of dementia, *Proceedings of the Nutrition Society*, **67**: 75–81.
- Collomb, M., Bütikofer, U., Sieber, R. *et al.* (2001) Conjugated linoleic acid and trans fatty acid composition of cows' milk fat produced in lowlands and highlands, *Journal of Dairy Research*, **68**: 519–523.
- Cook, N.R., Cutler, J.A., Obarzanek, E. *et al.* (2007) Long-term effects of dietary sodium reduction on cardiovascular disease outcomes: Observational follow-up on the trials of hypertension prevention, *British Medical Journal*, **334**: 885–888.
- Cousins, R.J. (2006) Zinc, in *Present Knowledge in Nutrition*, Vol. **1**, 9th edn (eds B.A. Bowman, and R.M. Russell). ILSI Press, Washington, DC, pp. 445–457.
- Couvreur, S., Hurtaud, C., Lopez, C. *et al.* (2006) The linear relationship between the proportion of fresh grass in the cow diet, milk fatty acid composition, and butter properties, *Journal of Dairy Science*, **89**: 1956–1969.
- Couvreur, S., Hurtaud, C., Marnet, P.G. *et al.* (2007) Composition of milk fat from cows selected for milk fat globule size and offered either fresh pasture or a corn silage-based diet, *Journal of Dairy Science*, **90**: 392–403.
- Cross, K.J., Huq, N.L. and Reynolds, E.C. (2007) Casein phosphopeptides in oral health – chemistry and clinical applications, *Current Pharmaceutical Design*, **13**: 793–800.
- DPC (Dairy Practices Council) (2001) Guideline for vitamin A and D fortification of fluid milk. Dairy Practices Council, Richboro, PA (<http://www.dairypc.org/catalog/vitamin-a-and-d-fortification-of-fluid-milk>; last accessed 11 January 2015).
- DRI (Dairy Research Institute) (2011) Quick reference guide. Nutrition claims for dairy products. Available at: <http://www.usdairy.com/~media/usd/public/quick-reference%20guide.pdf.pdf> (last accessed 11 January 2015).
- Dangour, A., Dodhia, S., Hayter, A. *et al.* (2009) Comparison of composition (nutrients and other substances) of organically and conventionally produced foodstuffs: A systematic review of the available literature. Report for the Food Standards Agency, London, p.1.
- Davies, K.M., Heaney, R.P., Recker, R.R. *et al.* (2000) Calcium intake and body weight, *Journal of Clinical Endocrinology and Metabolism*, **85**: 4635–4638.
- del Mar Contreras, M., Carron, R., Montero, M.J. *et al.* (2009) Novel casein-derived peptides with antihypertensive activity, *International Dairy Journal*, **19**: 566–573.
- Dewhurst, R.J., Fisher, W.J., Tweed, J.K.S., and Wilkins, R.J. (2003) Comparison of grass and legume silages for milk production, *Journal of Dairy Science*, **86**: 2598–2600.
- Dhiman, T.R., Anand, G.R., Satter, L.D. and Pariza, M.W. (2000) Conjugated linoleic acid content of milk from cows fed different diets, *Journal of Dairy Science*, **82**: 2146–2156.
- DSM (nd) Company website. http://www.dsm.com/markets/foodandbeverages/en_US/markets-home/market-dairy-lp.html (last accessed 11 January 2015).
- Elder, S.J., Haytowitz, D.B., Howe, J. *et al.* (2006) Vitamin K contents of meat, dairy, and fast food in the U.S. diet, *Journal of Agricultural and Food Chemistry*, **54**: 463–467.
- Elgersma, A., Tamminga, S. and Ellen, G. (2006) Modifying milk composition through forage, *Animal Feed Science and Technology*, **131**: 207–225.

- Elliot, P., Stamler, J., Nichols, R. *et al.* (1996) Intersalt revisited: further analyses of 24 hour sodium excretion and blood pressure within and across population, *British Medical Journal*, **312**: 1249–1253.
- Ellis, K.A., Innocent, G., Grove-White, D. *et al.* (2006) Comparing the fatty acid composition of organic and conventional milk, *Journal of Dairy Science*, **89**: 1938–1950.
- Evans, J. (2007) Primary prevention of age related macular degeneration, *British Medical Journal*, **335**: 729.
- Fang, B., Guo, H.Y., Zhang, M. *et al.* (2012) The six-amino acid antimicrobial peptide bLFcin₆ penetrates cells and delivers siRNA, *FEBS Journal*, **280**: 1007–1017.
- FDA (1990) Nutrition Labeling and Education Act of 1990, Public Law 101-535. US Government Printing Office, Washington, DC.
- FDA (1997) Food and Drug Administration Modernization Act of 1997. Public Law 105-115. US Government Printing Office, Washington, DC.
- FDA (2003) Claims that can be made for conventional foods and dietary supplements. US Government Printing Office, Washington, DC.
- FDA (2009) Guidance for Industry: Evidence-based review system for the scientific evaluation of health claims - final. US Government Printing Office, Washington, DC.
- FDA (2012) Code of Federal Regulations. Title 21. Part 101. Office of Federal Register, Washington, DC.
- Ferland, G. (2006) Vitamin K, in *Present Knowledge in Nutrition*, Vol. 1, 9th edn (eds B.A. Bowman, and R.M. Russell). ILSI Press, Washington, DC, pp. 220–230.
- Ferlay, A., Agabriel, C., Sibra, C. *et al.* (2008) Tanker milk variability in fatty acids according to farm feeding and husbandry practices in a French semi-mountain area, *Dairy Science and Technology*, **88**: 193–215.
- Field, C.J., Blewett, H.H., Proctor, S. and Vine, D. (2009) Human health benefits of vaccenic acid, *Applied Physiology and Nutritional Metabolism*, **34**: 979–991.
- FitzGerald, R.J., Murray, B.A. and Walsh, D.J. (2004) Hypotensive peptides from milk proteins, *Journal of Nutrition*, **134**: 980S-988S.
- Foltz, M., Van Buren, L., Klaffke, W. and Duchateau, G.S.M.J.E. (2009) Modeling of the Relationship between dipeptide structure and dipeptide stability, permeability, and ACE inhibitory activity, *Journal of Food Science*, **74**: H243-H251.
- FTC (Federal Trade Commission) (1994) Enforcement policy statement on food advertising. Available at: <http://ftc.gov/bcp/policystmt/ad-food.shtm> (last accessed 11 January 2015).
- Gladyshev, V.N. (2006) Selenoproteins and selenoproteomes, in *Selenium: Its Molecular Biology and Role in Human Health*, 2nd edn (eds D.L. Hatfield, M.J. Berry and V.N. Gladyshev). Springer, New York, pp. 99–114.
- Glynn, R.J., Ridker, P.M., Goldhaber, S.Z. *et al.* (2007) Effects of random allocation to vitamin E supplementation on the occurrence of venous thromboembolism: Report from the Women's Health Study, *Circulation*, **116**: 1497–1503.
- Griswold, K., Karreman, H., Dinh, S. and High, J. (2008a) Effects of nutrition and feeding management on production, health and culling by organically-managed dairy herds in Southeastern Pennsylvania, *Journal of Dairy Science*, **91**(E-Suppl. 1): 134.
- Griswold, K., Karreman, H. and High, J. (2008b) Effect of calving scheme, seasonal vs. year-round, on production, reproductive performance, and culling by organically-managed dairy herds in Southeastern Pennsylvania, *Journal of Dairy Science*, **91**(E-Suppl. 1): 469.

- Grummer, R.R. (1991) Effect of feed on the composition of milk fat, *Journal of Dairy Science*, **74**: 3244–3257.
- Gunn, J.P., Barron, J.L., Bowman, B.A. *et al.* (2013) Sodium reduction is a public health priority: reflections on the institute of medicine's report, sodium intake in populations: assessment of evidence, *American Journal of Hypertension*, **26**: 1178–1180.
- Haas, G., Deittert, C. and Köpke, U. (2007) Impact of feeding pattern and feed purchase on area- and cow-related dairy performance of organic farms, *Livestock Science*, **106**: 132–144.
- Heaney, R.P. (2000) Calcium, dairy products and osteoporosis, *Journal of the American College of Nutrition*, **19**(2 Suppl.): 83S–99S.
- Heaney, R.P. (2003) Long-latency deficiency disease: Insights from calcium and vitamin D, *American Journal of Clinical Nutrition*, **78**: 912–919.
- Hernandez-Ledesma, B., Recio, I. and Amigo, L. (2008) β -lactoglobulin as source of bioactive peptides, *Amino Acids*, **35**: 257–265.
- Hirota, T., Ohki, K., Kawagishi, R. *et al.* (2007) Casein hydrolysate containing the anti-hypertensive tripeptides Val-Pro-Pro and Ile-Pro-Pro improves vascular endothelial function independent of blood pressure-lowering effects: contribution of the inhibitory action of angiotensin-converting enzyme, *Hypertension Research*, **30**: 489–496.
- Holick, M.F. (2004) Vitamin D: Importance in the prevention of cancers, type 1 diabetes heart disease, and osteoporosis, *American Journal of Clinical Nutrition*, **79**: 362–371.
- Institute of Medicine. Food and Nutrition Board. (1997) Dietary Reference Intakes: Calcium, Phosphorus, Magnesium, Vitamin D, and Fluoride. National Academy Press, Washington, DC.
- Institute of Medicine. Food and Nutrition Board. (1998) Dietary Reference Intakes: Thiamin, Riboflavin, Niacin, Vitamin B₆, Folate, Vitamin B₁₂, Pantothenic Acid, Biotin, and Choline. National Academy Press, Washington, DC.
- Institute of Medicine. Food and Nutrition Board. (2000) Dietary Reference Intakes for Water, Potassium, Sodium, Chloride, and Sulfate. National Academy Press, Washington, DC.
- Institute of Medicine. Food and Nutrition Board. (2004) Dietary Reference Intakes for Vitamin C, Vitamin E, Selenium and Carotenoids. National Academy Press, Washington, DC.
- Institute of Medicine. Food and Nutrition Board. (2010) Dietary Reference Intakes for Calcium and Vitamin D. National Academy Press, Washington, DC.
- Ip, C., Scimeca, J.A. and Thompson, H.J. (1994) Conjugated linoleic acid: a powerful anti-carcinogen from animal fat sources, *Cancer*, **74**: 1050–1054.
- Jauhainen, T. and Korpela, R. (2007) Milk peptides and blood pressure, *Journal of Nutrition*, **137**: 8255–8295.
- Kelly, M.L., Kolver, E.S., Bauman, D.E. *et al.* (1998) Effect of intake of pasture on concentrations of conjugated linoleic acid in milk of lactating cows, *Journal of Dairy Science*, **81**: 1630–1636.
- Kelsey, J.A., Corl, B.A., Collier, R.J. and Bauman, D.E. (2003) The effect of breed, parity, and stage of lactation on conjugated linoleic acid (CLA) in milk fat from dairy cows, *Journal of Dairy Science*, **86**: 2588–2597.
- Khanal, R.C., Dhiman, T.R. and Bowman, R.L. (2008) Changes in fatty acid composition of milk from lactating dairy cows during transition to and from pasture, *Livestock Science*, **114**: 164–175.

- King, J.C. and Cousins, R.J. (2006) Zinc, in *Modern Nutrition in Health and Disease*, 10th edn (eds M.E. Shilis, M. Shike, A.C. Ross *et al.*). Lippincott Williams & Wilkins, Baltimore, MD, pp. 247–285.
- Knochel, J.P. (2006) Phosphorus, in *Modern Nutrition in Health and Disease*, 10th edn (eds M.E. Shilis, M. Shike, A.C. Ross *et al.*). Lippincott Williams & Wilkins, Baltimore, MD, pp. 211–222.
- Koivu-Tikkanen, T.J., Ollilainen, V. and Piironen, V. (2000) Determination of phyloquinone and menaquinones in animal products with fluorescence detection after post-column reduction with metallic zinc, *Journal of Agricultural and Food Chemistry* **48**: 6325–6331.
- Korhonen, H. (2009) Milk-derived bioactive peptides: From science to applications, *Journal of Functional Foods*, **1**: 177–187.
- Korhonen, H. and Pihlanto, A. (2006) Bioactive peptides: Production and functionality, *International Dairy Journal*, **16**: 945–960.
- Kraft, J., Collomb, M., Möckel, P. *et al.* (2003) Differences in CLA isomer distribution of cow's milk lipids, *Lipids*, **38**: 657–664.
- Lahov, E. and Regelson, W. (1996) Antibacterial and immunostimulating casein-derived substances from milk: casecidin, isracidin peptides, *Food and Chemical Toxicology*, **34**: 131–145.
- Larsson, S.C., Virtanen, M.J., Mars, M. *et al.* (2008) Magnesium, calcium, potassium, and sodium intakes and risk of stroke in male smokers, *Archives of Internal Medicine*, **168**: 459–465.
- Legrand, D. and Mazurier, J. (2010) A critical review of the roles of host lactoferrin in immunity, *Biometals*, **23**: 365–376.
- Legrand, D., Pierce, A., Ellass, E. *et al.* (2008) Lactoferrin structure and functions, *Advances in Experimental Medicine and Biology*, **606**: 163–194.
- Lichtenstein, A.H., Appel, L.J., Brands, M. *et al.* (2006) Diet and lifestyle recommendations revision 2006: a scientific statement from the American Heart Association Nutrition Committee, *Circulation*, **114**: 82–96.
- Lin, H., Boylston, T.D., Chang, M.J. *et al.* (1995) Survey of the conjugated linoleic acid contents of dairy products, *Journal of Dairy Science*, **78**: 2358–2365.
- Lin, Y.C., Lyle, R.M., McCabe, L.D. *et al.* (2000) Dairy calcium is related to changes in body composition during a two-year exercise intervention in young women, *Journal of the American College of Nutrition*, **19**: 754–760.
- Lindmark-Månsson, H. and Åkesson, B. (2000) Antioxidative factors in milk, *British Journal of Nutrition*, **84**(Suppl. 1): S103-S110.
- Lonn, E., Yusuf, S., Arnold, M.J. *et al.* (2006) Homocysteine lowering with folic acid and B vitamins in vascular disease, *New England Journal of Medicine*, **354**: 1567–1577.
- Lopez-Exposito, I. and Recio, I. (2008) Protective effect of milk peptides: antibacterial and antitumor properties, *Advances in Experimental Medicine and Biology*, **606**: 271–293.
- Lopez-Fandino, R., Otte, J. and van Camp, J. (2006) Physiological, chemical and technological aspects of milk-protein-derived peptides with antihypertensive and ACE-inhibitory activity, *International Dairy Journal*, **16**: 1277–1293.
- Martin, B., Verdier-Metz, I., Cornu, A. *et al.* (2002) Do terpenes influence the flavour of cheeses? II. *Cantal cheese*, *Caseus International*, **3**: 25–27.
- McCormick, D.B. (2006) Riboflavin, in *Modern Nutrition in Health and Disease*, 10th edn (eds M.E. Shilis, M. Shike, A.C. Ross *et al.*). Lippincott Williams & Wilkins, Baltimore, MD, pp. 434–441.

- Meisel, H. (1998) Overview on milk protein-derived peptides, *International Dairy Journal*, **8**: 363–373.
- Meisel, H. and Bockelmann, W. (1999) Bioactive peptides encrypted in milk proteins: proteolytic activation and thropho-functional properties, *Antonie Van Leeuwenhoek*, **76**: 207–215.
- Mensink, R.P., Zock, P.L., Kester, A.D.M. and Katan, M.B. (2003) Effects of dietary fatty acids and carbohydrates on the ratio of serum total to HDL cholesterol and on serum lipids and apolipoproteins: a meta-analysis of 60 controlled trials, *American Journal of Clinical Nutrition*, **77**: 1146–55.
- Merlino, L.A., Curtis, J., Mikuls, T.R. *et al.* (2004) Vitamin D intake is inversely associated with rheumatoid arthritis: Results from the Iowa Women's Health Study, *Arthritis and Rheumatism*, **50**: 72–77.
- Michalski, M.-C. and Januel, C. (2006) Does homogenization affect the human health properties of cow's milk?, *Trends in Food Science & Technology*, **17**: 423–437.
- Miller, G.D., DiRienzo, D.D., Reusser, M.E. and McCarron, D.A. (2000) Benefits of dairy product consumption on blood pressure in humans: a summary of the biomedical literature, *Journal of the American College of Nutrition*, **19**(2 Suppl): 147S–164S.
- Moore, R.L., Duncan, S.E., Rasor, A.S. *et al.* (2012) Oxidative stability of an extended shelf-life dairy-based beverage system designed to contribute to heart health, *Journal of Dairy Science*, **95**: 6242–6251.
- Munger, K.L., Zhang, S.M. and O'Reilly E. (2004) Vitamin D intake and incidence of multiple sclerosis, *Neurology*, **62**: 60.65.
- Munger, K.L., Levin, L.I., Hollis, B.W. *et al.* (2006) Serum 25-hydroxyvitamin D levels and risk of multiple sclerosis, *Journal of the American Medical Association*, **296**: 2832–2838.
- Nagpal, R., Behare, P., Rana, R. *et al.* (2011) Bioactive peptides derived from milk proteins and their health beneficial potentials: an update, *Food and Function*, **2**: 18–27.
- Nakamura, Y., Yamamoto, N., Sakai, K. *et al.* (1995a) Purification and characterization of angiotensin I-converting enzyme inhibitors from sour milk, *Journal of Dairy Science*, **78**: 777–783.
- Nakamura, Y., Yamamoto, N., Sakai, K. and Takano, T. (1995b) Antihypertensive effect of sour milk and peptides isolated from it that are inhibitors to angiotensin I-converting enzyme, *Journal of Dairy Science*, **78**: 1253–1257.
- Nakamura, T., Mizutani, J., Ohki, K. *et al.* (2011) Casein hydrolysate containing Val-Pro-Pro and Ile-Pro-Pro improves central blood pressure and arterial stiffness in hypertensive subjects: a randomized, double-blind, placebo-controlled trial, *Atherosclerosis*, **219**: 298–303.
- National Academy of Sciences. (1996) *Carcinogens and Anticarcinogens in the Human Diet: A Comparison of Naturally Occurring and Synthetic Substances*. National Academy Press, Washington, DC, p. 85.
- NIH (National Institutes of Health) (2012) Dietary supplement fact sheet: Vitamin A. Available at: <http://ods.od.nih.gov/factsheets/VitaminA-HealthProfessional/> (last accessed 11 January 2015).
- Nozière, P., Graulet, B., Lucas, A. *et al.* (2006) Carotenoids for ruminants: From forages to dairy products, *Animal Feed Science and Technology*, **131**: 418–450.
- O'Dell, B.L. (2000) Role of zinc in plasma membrane function, *Journal of Nutrition*, **130**: 271–285.
- Oliver, S.P., Boor, K.J., Murphy, S.C. and Murinda, S.E. (2009) Food safety hazards associated with consumption of raw milk, *Foodborne Pathogens and Disease*, **6**: 793–806.

- Parodi, P.W. (2006) Nutritional significance of milk lipids, in *Advanced Dairy Chemistry*, Vol. 2, 3rd edn (eds P.F. Fox and P.L.H. McSweeney). Springer, New York, pp. 601–639.
- Paul, M. and Van Hekken, D.L. (2011) Short communication: Assessing antihypertensive activity in native and model Queso Fresco cheeses, *Journal of Dairy Science*, **94**: 2280–2284.
- Pellegrini, A. (2003) Antimicrobial peptides from food proteins, *Current Pharmaceutical Design*, **9**: 1225–1238.
- Pfeifer, M., Begerow, B., Minne, H.W. *et al.* (2001) Effects of a short-term vitamin D₃ and calcium supplementation on blood pressure and parathyroid hormone levels in elderly women, *Journal of Clinical Endocrinology*, **86**: 1633–1637.
- Pihlanto, A., Virtanen, T. and Korhonen, H. (2010) Angiotensin I converting enzyme (ACE) inhibitory activity and antihypertensive effect of fermented milk, *International Dairy Journal*, **20**: 3–10.
- Quirós, A., Ramos, M., Muguerza, B. *et al.* (2007) Identification of novel antihypertensive peptides in milk fermented with *Enterococcus faecalis*, *International Dairy Journal*, **17**: 33–41.
- Quiros, A., Hernandez-Ledesma, B., Ramos, M. *et al.* (2012) Short communication: Production of antihypertensive peptide HLPLP by enzymatic hydrolysis: optimization by response surface methodology, *Journal of Dairy Science*, **95**: 4280–4285.
- Richman, A. (2012) Children's Vitamins: Nutrients for Kids. *Nutritional Outlook* [online] (<http://www.nutritionaloutlook.com/article/children%E2%80%99s-vitamins-healthy-nutrients-kids-3-10544>; last accessed 14 January 2015).
- Rindi, G. (1996) Thiamin, in *Present Knowledge in Nutrition*, 7th edn (eds E.E. Zeigler, and L.J. Filer). ILSI Press, Washington, DC, pp. 160–166.
- Roca Fernandez, A.I. and Gonzalez Rodriguez, A. (2012) Effect of dietary and animal factors on milk fatty composition of grazing dairy cows: a review. *Iranian Journal of Applied Animal Science*, **2**: 97–109.
- Ross, C.A. (2010) Vitamin A, in *Encyclopaedia of Dietary Supplements*, 2nd edn. Informa Healthcare, London, pp. 778–791.
- Saito, T. (2008) Antihypertensive peptides derived from bovine casein and whey proteins, *Advances in Experimental Medicine and Biology*, **606**: 295–317.
- Saito, T., Nakamura, T., Kitazawa, H. *et al.* (2000) Isolation and structural analysis of antihypertensive peptides that exist naturally in Gouda cheese, *Journal of Dairy Science*, **83**: 1434–1440.
- Sato, K., Bartlett, P.C., Erskine, R.J. and Kaneene, J.B. (2005) A comparison of production and management between Wisconsin organic and conventional dairy herds, *Livestock Production Science*, **93**: 105–115.
- Schroeder, G.F., Delahoy, J.E., Vidaurreta, I. *et al.* (2003) Milk fatty acid composition of cows fed a total mixed ration or pasture plus concentrates replacing corn with fat, *Journal of Dairy Science*, **86**: 3237–3248.
- Séverin, S. and Xia, W. (2005) Milk biologically active components as nutraceuticals: Review, *Critical Reviews in Food Science and Nutrition*, **45**: 645–656.
- Shearer, M.J. (1997) The roles of vitamin D and K in bone health and osteoporosis prevention, *Proceedings of the Nutrition Society*, **56**: 915–937.
- Sheng, H.-W. (2000) Sodium, chloride and potassium, in *Biochemical and Physiological Aspects of Human Nutrition* (ed. M. Stipanuk). W.B. Saunders Co., Philadelphia, PA, pp. 687–710.

- Singh, T.K., Fox, P.F. and Healy, A. (1997) Isolation and identification of further peptides in the diafiltration retentate of the water-soluble fraction of Cheddar cheese, *Journal of Dairy Research*, **64**: 433–443.
- Sipola, M., Finckenberg, P., Vapaatalo, H. *et al.* (2002) α -lactorphin and β -lactorphin improve arterial function in spontaneously hypertensive rats, *Life Sciences*, **71**: 1245–1253.
- Spitsberg, V.L. (2005) Invited review: Bovine milk fat globule membrane as a potential nutraceutical, *Journal of Dairy Science*, **88**: 2289–2294.
- Stanton, C., Lawless, F., Kjellmer, G. *et al.* (1997) Dietary influences on bovine milk *cis*-9,*trans*-11-conjugated linoleic acid content. *Journal of Food Science*, **62**: 1083–1086.
- Stockdale, C.R., Walker, G.P., Wales, W.J. *et al.* (2003) Influence of pasture and concentrates in the diet of grazing dairy cows on the fatty acid composition of milk, *Journal of Dairy Research*, **70**: 267–276.
- Teschemacher, H., Koch, G. and Brantl, V. (1997) Milk protein-derived opioid receptor ligands, *Biopolymers*, **43**: 99–117.
- Toledo, P., Andr n, A. and Bj rck, L. (2002) Composition of raw milk from sustainable production systems, *International Dairy Journal*, **12**: 75–80.
- Tomita, M., Bellamy, W., Takase, M. *et al.* (1991) Potent antibacterial peptides generated by pepsin digestion of bovine lactoferrin, *Journal of Dairy Science*, **74**: 4137–4142.
- Torres-Llanez, M.J., Gonzalez-Cordova, A.F., Hernandez-Mendoza, A. *et al.* (2011) Angiotensin-converting enzyme inhibitory activity in Mexican Fresco cheese, *Journal of Dairy Science*, **94**: 3794–3800.
- Traber, M.G. (2006) Vitamin E, in *Modern Nutrition in Health and Disease*, 10th edn (eds M.E. Shilis, M. Shike, A.C. Ross *et al.*). Lippincott Williams & Wilkins, Baltimore, MD, pp. 396–411.
- Trumbo, P.R. (2006) Pantothenic acid, in *Modern Nutrition in Health and Disease*, 10th edn (eds M.E. Shilis, M. Shike, A.C. Ross *et al.*). Lippincott Williams & Wilkins, Baltimore, MD, pp. 462–469.
- Tucker, K.L., Hannan, M.T., Chen, H. *et al.* (1999) Potassium, magnesium, and fruit and vegetable intakes are associated with greater bone mineral density in elderly men and women, *American Journal of Clinical Nutrition*, **69**: 727–736.
- Turpeinen, A.M., Mutanen, M., Aro, A. *et al.* (2002) Bioconversion of vaccenic acid to conjugated linoleic acid in humans. *American Journal of Clinical Nutrition*, **76**: 504–510.
- USDA (United States Department of Agriculture) (2012) Nutrient data for milk, whole, 3.25% milkfat, without added vitamin A and vitamin D. National Nutrient Database for Standard Reference, Release 25. (<http://ndb.nal.usda.gov/ndb/foods>; last accessed 12 January 2015).
- Valenti, P. and Antonini, G. (2005) Lactoferrin: an important host defence against microbial and viral attack, *Cellular and Molecular Life Sciences*, **62**: 2576–2587.
- Valenti, P., Marchetti, M., Superti, F. *et al.* (1998) Antiviral activity of lactoferrin, *Advances in Experimental Medicine and Biology*, **443**: 199–203.
- Wang, F., Van Den Eeden, S.K., Ackerson, L.M. *et al.* (2003) Oral magnesium oxide prophylaxis of frequent migrainous headaches in children: a randomized, double-blind, placebo-controlled trial, *Headache*, **43**: 601–610.
- Ward, L. (2012) Functional ingredients for fortified dairy, *Food Manufacturing*, **25**: 38. (Available at: <http://www.foodmanufacturing.com/articles/2012/09/functional-ingredients-fortified-dairy>; last accessed 12 January 2015).

- Weaver, C.M. and Heaney, R.P. (2006) Calcium, in *Modern Nutrition in Health and Disease*, 10th edn (eds M.E. Shilis, M. Shike, A.C. Ross *et al.*). Lippincott Williams & Wilkins, Baltimore, MD, pp. 194–210.
- Welderufael, F.T., Gibson, T. and Jauregi, P. (2012) Production of angiotensin-I-converting enzyme inhibitory peptides from β -lactoglobulin- and casein-derived peptides: an integrative approach, *Biotechnology Progress*, **28**: 746–755.
- Weller, R.F. and Bowling, P.J. (2007) The importance of nutrient balance, cropping strategy and quality of dairy cow diets in sustainable organic systems, *Journal of the Science of Food and Agriculture*, **87**: 2768–2773.
- Wharton, B. and Bishop, N. (2003) Rickets, *Lancet*, **362**: 1389–1400.
- Whelton, P.K., He, J., Cutler, J.A. *et al.* (1997) Effects of oral potassium on blood pressure. Meta-analysis of randomized controlled clinical trials, *Journal of the American Medical Association*, **277**: 1624–1632.
- White, S.L., Bertrand, J.A., Wade, M.R. *et al.* (2001) Comparison of fatty acid content of milk from Jersey and Holstein cows consuming pasture or a total mixed ration, *Journal of Dairy Science*, **84**: 2295–2301.
- Zhu, K., Devine, A. and Prince, R.L. (2009) The effects of high potassium consumption on bone mineral density in a prospective cohort study of elderly postmenopausal women, *Osteoporosis International*, **20**: 335–340.
- Zimecki, M. and Kruzel, M.L. (2007) Milk-derived proteins and peptides of potential therapeutic and nutritive value, *Journal of Experimental Therapeutics and Oncology*, **6**: 89–106.
- Zucht, H.D., Raida, M., Adermann, K. *et al.* (1995) Casocidin-I: a casein- α_2 derived peptide exhibits antibacterial activity, *FEBS Letters*, **372**: 185–188.

Index

References to figures are given in *italic* type. References to tables are given in **bold** type.

- Acinetobacter* spp., 17, 224
acoustic streaming, 159
actinometry, 188, 195
Aeromonas hydrophila, **212**
age thickening, 164
Alicyclobacillus acidoterrestris, 199, **212**, 222
alkaline phosphatase, 42, **57**, 59
Allura Red AC, 140
ALTA 2431, 274
angiotensin-converting enzyme (ACE), 311
animal feeds, 308
antioxidants, 130, 136–138, 229, 316
aroma, 127–8, 137–8, 230, 235
Aspergillus spp., 225
Aspergillus niger, 196, **212**
Australia, 194
- Bacillus* spp., 15, 16, 20, **120**, 189, 267
 thermal inactivation, 57
Bacillus anthracis, 20
Bacillus cereus, 222, 231, **282**, **284**
Bacillus licheniformis, 231, 285
Bacillus subtilis, 157, **212**, 289, 183
Bacillus subtilis protease, 126
back-pulsing, 6
bacteria *see* microbial inactivation
- bactericides, 124
bacteriocins, 268–73
 applications, 273–4
 food safety, 274–5
 sensory effects, 275–6
 class I, 269–70
 class II, 271, 272–3
 class IIb, 271–2
 emerging technologies and, 280
 expression, 272
 hurdle technology and, 277–80
 natural preservatives and, 285–7
 resistance to, 276–7
 structure and production, 268–71
 thermal processing and, 279–80
bacteriofugation, 15
Bactocatch process, 5
Beta-serum, 235
beverages, 192–4
 carbon dioxide treatment, 233–4
 flavoured milk, **133**
 fruit juice-milk, 130–7, **131–2**
 fruit juice-soya milk, **132**
 yoghurt-based, 138
Bifidobacterium bifidum, 234, 234
bile salt stimulated lipase (BSSL), 192
bioactive compounds, 311–13, 22–3
biodosimetry, 188

- breweries, 192
Brochothrix thermosphacta, **212**, **217**
butter, 234
buttermilk, 21–2
- Caciotta cheese, 106
calcium, 310
Campylobacter spp., 268
cancer, 310, 316
Candida lambica, **212**
capacitance coupling, 252–3
carbon dioxide, 206
 cheese manufacture, 236–7
 cottage cheese, 232–3
 fermented and flavoured dairy
 beverages, 233–4
 fractionation
 lipids, 234–5
 proteins, 237–9
 freezing an, 208–9
 high-pressure, 226–7
 low-pressure injection *see*
 carbonation
 mechanism of action, 209–10
 microbial inactivation, 209–11,
 211–22, 223–5
 food composition and, 225–6
 inactivation kinetics, 223
 processing parameters, 211
 physicochemical properties, 206–7
 regulatory status, 239
 solubility in aqueous solutions, 207–8
 solubility in milk, 208–9
 yoghurt, 233
carbonation, 207–8
 advantages, 228
 fermented and flavoured dairy
 beverages, 233–4
 pasteurized milk, 231–2
 product quality and, 229–30
 raw milk, 230–1
 β -carotene, 320
carotenoids, 136
casein, 19, 21
 carbon dioxide and, 208, 237
 dehydrated powders, 162
 denaturation, 238
 fouling, 12
 high-pressure homogenization, 101–2
 high-pressure treatment and, 76–7
 yoghurt, 83
 microwave heating, 52–3
 sonication, 163–4
cavitation, 96
 ultrasound, 150, 152
cheese 80, **81**, 235, 236
 high-pressure homogenization, 105–6
 high-pressure processing, 79–83, **81**
 lactic acid bacteria (LAB), **270**
CHIEF *see* concentrated high intensity
 electric field
children, 322
CiderSure 3500, 185, 185, 189–90
Claranor, 199
clean-in-place (CIP) processes, 1
Clostridium spp., 280
Clostridium botulinum, 16, 228, 230
Clostridium perfringens, **282**, 289
Clostridium tyrobutyricum, 122
Colostrum, 84
competition sensing, 273–4
concentrated high intensity electric field
 (CHIEF), 251
 equipment, 253, 255–8, 256
 development, 262
 future development, 261
 as hurdle technology, 262–3
 microbial inactivation, 258–9
 other applications, 261
 physical principles, 253–5
 quality effects, 259–61
conjugated linoleic acid (CLA), 314,
 320, 321
Consumer Health Information for
 Better Nutrition
 Initiative, 310
cottage cheese, 50, 232–3, **49**
cream liquors, 107–8
creaming, 155
critical transmembrane potential, 119
Cronobacter sakazakii, 139, 157
crossflow microfiltration
 cleaning, 4, 6, 157–9
 fluid models, 8–10
 gel polarization, 10–11
 resistance-in-series, 12–13
 membrane types, 1–3, 4
 microfiltration (MF), 2, 3–6, **3**

- fluid models, 8–10
- pilot plants, 6–8
- models, osmotic pressure, 11–12
- nanofiltration (NF), 2
- operating pressure, **3**
- pilot plants, 6–8
- reverse osmosis (RO), 2
- ultrafiltration (UF), 157–9
- crossflow velocity (CFV), 1
- cryo-concentration, 50
- Cryptosporidium parvuum*, 189

- dairies, 307–8
- Darcy's law, 8, 12
- Dean effect, 187
- degassing, 155
- diabetes, 315
- dielectric heating, 43, 45
- dielectric properties, **46, 47**
- diglycerides, 235
- dipolar rotation, 41
- Dittus–Boelter equation, 11
- Diversified Technologies Inc., 117
- DNA mutation, 188

- eggs, 280
- electrical conductivity, 37–8
- electrical resistance heating *see* ohmic heating
- Electropure Process, 40
- electrostatic interactions, 172
- emulsifiers, 225
- emulsions, 93
 - breakdown process, 95
 - mechanical emulsification process, 95
 - stability, 94–8
- Enteriobacter sakazakii*, 198
- Enteriobacter* spp., 224
- enterocin A, 279, **282**
- Enterococcus* spp., 267
- Enterococcus durans*, **270, 272**
- Enterococcus faecalis*, **212, 217, 222, 224, 231, 270**
- enzymes, 102–3
 - high-pressure processing, 77–8
 - pulsed electric field (PEF), 125, 135
 - ultrasound, 157
- Escherichia* spp., 189, 190
 - Escherichia coli*, **57, 58, 60, 119, 120, 122, 157, 198, 231, 258, 259, 283**
 - bacteriocin treatment, 288
 - carbon dioxide treatment, **212–13, 217**
 - CHIEF, 258
 - high-pressure treatment, **79**
 - essential oils, 285
 - ethanol, 279
 - Ewe's milk cheese, 80
 - extended shelf life (ESL) milk, 15–20, 197
 - carbon footprint, 17–19
 - quality and safety, 19–20
 - fats, 225
 - fatty acids, 138, 235, 313–14, 321–2, 52
 - organic milk, 319
 - FDA Modernization Act (FDA, 1997), 310
 - feed, 320–1
 - fish oil, 321
 - Flavobacterium* spp., 224
 - flavoured milk, **133, 140**
 - fluence, 195
 - fluorescence of advanced Maillard products and soluble tryptophane (FAST), 42
 - foam reduction, 155–6
 - Food and Drug Administration (FDA), 239, 268, 309–10
 - fouling
 - microfiltration, 8, 9
 - ohmic heating, 36, 41–2
 - fractionation, 76, 206
 - lipids, 234–5
 - proteins, 237–9
 - frankfurters, 280
 - free fatty acids (FFA), 235
 - freeze-drying, **49, 51, 170**
 - fruit juice-milk beverages, 130–7, **131–2**
 - fruit juice-soya milk beverages, **132**
 - fruit smoothies, **133**
 - fruits, **73**
 - functional dairy products, 83–4
 - furosine, 19
 - β -galactosidase, **57**
 - Gassericin A, **282**

- gel polarization models, 10–11
gelation, whey proteins, 167, 168
Geotrichum spp., 225
glycerol, 226
glycomacropeptide, 236
goat milk, **41**, 189
Gouda cheese, **81**, 80
graded permeability (GP)
 membranes, 5, 13
 bacterial spore elimination, 20
growth factors, 22
- headspace packaging, 239
health claims, 309–10
heat treatment *see* thermal processing
high-pressure carbon dioxide
 (HPCD), 206
high-pressure homogenization, 94
 applications
 cheese, 105–6
 ice cream, 106–7
 milk, 103–4
 microbial inactivation, 103
 microfluidization, 98–9
 milk fat globules, 99–101
 nozzles and valves, 96–8, 97
 flow geometries, 98
 principles, 96–8
high-pressure processing, 71–3
 bacteriocins and, 288–9
 cheese, 79–83, **81**, 79–83
 effects on physical and chemical
 equilibria, 74
 functional dairy products, 83–4
 homogenization *see* high-pressure
 homogenization
 ice cream, 84–5
 microbial inactivation, 78–9
milk
 enzymes, 77–8
 fat and fat globules, 75
 rheological properties, 78
 salt solubility, 74–5
 whey proteins, 75–6
pressure levels, 72
products treated, **73**
system components, 72
yoghurt, 83
- high-temperature short-time (HTST)
 pasteurization, 19, 104, 205,
 260
 pulsed electric field and, 128–9
homeostasis, 277–8
homogenization, 19, 93–4
 applications, yoghurt, 104–5
 cream liquors, 107–8
 droplet breakup, 94–5
 emulsion stability, 94–6
 pressures, 101
 principles, 96–8
 ultrasound, 152–5
human milk, 192
hurdle technology, 205–6
hurdles, 205, 262–3
 bacteriocins, 277–80, **282–4**
hydrophobicity, 172
hypertension, 311–12
hypothiocyanite ions, 285
- ice cream, 234, 41
 high-pressure processing, 84–5
 microbial inactivation, 103
 microwave heating, 50
ice cream mixes, 40, 103
illness, 267–8
immunoglobulins, 84
infant formula milk, **133**, 138–9, 21, 50,
 53, 139, 151, 157, 170, 197
iodine, 318
ionization reactions, 74
isoflavones, 138, 138
Isoflux membranes, 5, 13, 14, 17
 bacterial spore elimination, 20
isostatic principle, 71
- joule heating *see* ohmic heating
juices and beverages, **73**, 117–18
 carbonation, 229–30
 pulsed electric field treatment, 130–7,
 131–3
 ultraviolet absorption, **184**
- kefir, 41
- La Serena, **81**
lactic acid bacteria (LAB), 268–9, 224
lactacin 3147, 275

- Lactobacillus* spp., 228, 270
Lactobacillus acidophilus, 234, 234
Lactobacillus brevis, 137, **213**, **270**
Lactobacillus plantarum, 134, **213**
Lactobacillus sakei subsp. carnosum, **213**
Lactococcus lactis, **270**, 271, 275, **282**
lactoferrin, 312, 318
 β -lactoglobulin, 52, 75–6, 198–9
lactoperidose, 19
lactoperoxidase–thiocyanate–hydrogen peroxide system (LPS), 285
lactose, sonocrystallization, 159–61
lactulose, 19
lantibiotics, 269–71, 276–7
Laplace pressure, 94
lassi, 234
Le Chatelier's principle, 71
Legionella dunnifii, **213**
Leveque equation, 11
lipoprotein lipase, 77–8, 102, 104
lipoxygenase (LOX), 137
lipozyme, 235
Listeria innocua, **58**, 60, **79**, 119, 137, 157, 198, **213**, **259**, 286, 287, **120**
Listeria monocytogenes
 bacteriocins, 268, 271–87, **281–4**
 carbon dioxide treatment, 226, 228, 231
 concentrated high-intensity electric field (CHIEF), 251, **259**, **260**
 filtration, 20
 microwave heating, 59
 pulsed electric field treatment, 119, **121**, 123
 pulsed light treatment, 191, 193, 197
 sonication, 156
 ultraviolet treatment, 189
lysozyme, 124–5, 286, 289

magnesium, 318
magnetron, 43
Maillard reaction, 19, 42, 49, 52, 57, 71, 268
malondialdehyde and other reactive substances (MORS), 191
Marguerite milk, 19
meat products, **73**
micellar calcium phosphate (MCP), 74–5
microbial inactivation, 55–60
 bacteriocins *see* bacteriocins
 carbon dioxide, 209–11, **211–22**, 223–5
 broths and growth media, **212–16**
 carbonation, 230
 food composition and, 225–6
 inactivation kinetics, 223
 milk and food ingredients, **217–22**
 processing parameters, 211
concentrated high intensity electric field (CHIEF), 251–2, 258–9
high-pressure homogenization, 103
high-pressure treatment, 78–9
pulsed electric field (PEF), 119–25, **120**, 130–4
pulsed light (PL), mechanism of action, 196
reaction kinetics, 55
thermosonication, 156–7
ultraviolet, 182, 189–92
 mechanism of action, 188–9
see also pasteurization
Micrococcus spp., 267
microfiltration (MF), 2, 3–6, **3**
 applications, 3, 13–15
 cheese brine spore reduction, 23
 cold milk processing, 20–1
 extended milk shelf life, 15–20
 milk bioactive compound separation, 22–3
 milk fat fractionation, 21–2
 production of concentrated micellar casein and whey Proteins, 13–15
carbon footprint, 17–19
ceramic membranes, 4
concentration polarization, 8, 9
fluid models, 8–10
 gel polarization, 10–11
 osmotic pressure, 11–12
 resistance-in-series, 12–13
fouling, 8, 9, 12
hydrophilic membranes, 4–5
membrane cleaning, 4, 6, 157–9
membrane modifications, 23
membrane selectivity, 5
membrane types, 4

- microfiltration (MF) (*continued*)
 microsieves, 23–4
 pilot testing, 5–6
 plant configuration, 16, 18
 process schematic, 7
 pulsed electric field and, 129–30
 temperature effects, 8
- microfluidization, 98–9, 100–1
 cheese, 106
 cream liquors, 107–8
 ice cream, 106–7
 microbial inactivation, 103
- Microgard[®], 286
- microsieves, 23–4
- microwave heating, 41–2, **49**
 applications, 48–54, **49**
 bacterial inactivation, 51
 composition, 45
 continuous flow vs batch systems, 59
 dielectric properties of dairy
 products, **46**
 flow conditions, 48
 frequency, 44–5
 microbial inactivation, **58**
 physical properties of sample, 47–8
 principles, 43–4
 vitamin content and, 53–4
- milk concentrates, 164–7
- milk enzymes *see* enzymes
- milk fat globule membrane
 (MFGM), 22, 75–6, 93–4,
 152
 organic milk, 320
- milk fat globules, size
 distribution, 99–101
- minerals, macro, 317–18
- modified atmosphere packaging
 (MAP), 209
- molecular weight cut-off size
 (MWCO), 2
- monolaurin, 285
- monoglycerides, 235
- monounsaturated fatty acids
 (MFA), 314
- mozzarella, **81**, 106
- Mycobacterium avium subsp*
 paratuberculosis
 (MAP), 190
- Mycobacterium paratuberculosis*, 122
- nanofiltration (NF), **3**
 applications, 2
- nisin, 124–5, 272, 273–4, 279, 281, **282**,
 283–4, 285–7, 288, 274
 resistance, 276
- NIZO, 151
- nonstarter lactic acid bacteria
 (NSLAB), 275–6, 275–6
- Nutrition Labeling and Education Act
 (FDA, 1990), 309
- nutritional claims, 308–11
- ohmic heating, 36–40
 applications, 40–2
 electrical conductivity, 37–8
 fouling, 36, 41–2
 heater configuration, 39
 microbial inactivation, **57**
 particle orientation
 characteristics, 38–9
 product characteristics, 40
- Ohm's law, 37
- orange juice, 259–61
- organic acids, 285–6
- Organic Foods Production Act
 (1990), 308
- organic milk, 307
 dairies, 307–8
 feed changes, 320–1
 future trends, 321–2
 nutritional claims, 308–11
- osmotic pressure model, 11–12
- outbreaks of illness, 267–8
- ovine milk, 23, 106
- packaging, 192, 199, 232–3
- Paenibacillus* spp., 225
- paneer, 50, **49**
- Parmesan cheese, 235
- pasta filata curd, **49**, 50
- pasteurization
 in bottle sterilization, **34**
 by pulsed electric field, 139–40
 cold, 20–1
 electrical, 40
 high temperature, **34**
 high temperature short time
 (HTST), 19
 low-temperature, **34**

- microwave, 48–50, 51–2
- organic milk, 318–19
- pulsed light, 198–9
- ultra, **34**
- ultraviolet, 185–6
 - see also microbial inactivation
- Pasteurized Milk Ordinance (PMO), 194
- Pecorino cheese, 106
- pectinmethylesterase (PME), 135
- pediocin, 272, 273, 274, 279
- Penicillium* spp., 225
- peptides
 - antimicrobial, 312
 - opiate, 312–13
- permeate flux, 1
- peroxidase, 137
- phytosterol enrichment, 52
- pilot plants, microfiltration, 6–8
- plasmin, 19, 77–8, 102, 231
- polyethersulfone (PES), 24
- polygalacturonase (PG), 135
- polymeric membranes, 4
- polyunsaturated fatty acids (PUFA), 314
- poly(vinylidene fluoride) (PVDF), 4
- potassium, 318
- powdered milk, 162, **49**, 51
- power ultrasound, 150
- Propionibacteria* spp., 224, 286
- proteinase plasmin, 102
- Pseudomonas aeruginosa*, **214**
- Pseudomonas fluorescens*, 119, **120**, 156, **214**, **218**, 226, 230–1, 288
- Pseudomonas* spp., 189, 197, 224
- Psychrobacter* spp., 17
- pulsed electric field (PEF)
 - treatment, 115–16
 - bacteriocins and, 280, 287–8
 - bioactive compounds, 128
 - chamber design, 115–16
 - cofield designs, 115–16
 - combined with pasteurization, 128–9
 - commercial applications, 140–1
 - enzyme inactivation, 125–6, 135
 - equipment, 117–18
 - field strength, 116
 - fruit juice-milk beverages, 130–7
 - microbial inactivation, 119–25, **120**, 130–4
 - combined with antimicrobial compounds, 124
 - microorganism characteristics and, 122
 - microfiltration and, 21
 - nutrient degradation, 136
 - other beverages, 139–40
 - physicochemical and sensory properties
 - fruit juice-milk beverages, 136–7
 - milk, 126–8
 - pulse shape, 116
 - quality-related enzymes, 125–6
 - shelf life extension, 128–30
 - soya milk-based beverages, **132**, 137–8
 - yoghurt-based beverages, 138
- pulsed light technology, 194–5
 - commercial developments, 199
 - microbial inactivation, mechanism of action, 196
- PurePulse Technologies Inc., 117, 194
- Quark, 14
- Queso Blanco, 274
- Queso Fresco, **81**, 106
- radiofrequency (RF) heating
 - applications, **49**
 - microbial inactivation, 51, 54, **58**
 - composition, 45
 - flow conditions, 48
 - frequency, 44–5
 - physical properties of sample, 47–8
 - principles, 43–4
 - temperature, 45–6
- radiometry, 188
- raw milk, 19–20, 93, 285
 - carbon dioxide content, 208
 - carbonation, 230–1
 - cheeses, 79, 288
 - lactoperoxidase–thiocyanate–hydrogen peroxide system (LPS), 285
- retentate, 2
- reuterin, 285
- reverse osmosis (RO), 2, **3**
 - applications, 2
- rheumatoid arthritis, 315
- riboflavin, 315, 316

- Saccharomyces cerevisiae*, 196–7
Saccharomyces cerevisiae, **214–15**
salami, 278
Salmonella spp., 20, 54, **121**, 123, 134, 157, **215**, **259**
salt, 225
salts, 74–5
saturated fatty acids (SFA), 314
seafood products, **73**
serum protein (SP), removal, 13–14
shelf life, 205
shelf life extension, 128–30
Sherwood number, 11
Sievecorp, Inc., 23
sodium, 318
solid phase microextraction (SPME), 136
somatic cells, 225
sonication *see* ultrasound
sonitrodes, 151
sonocrystallization, 159–61
sour cream, 234
soya milk, **132**, 137–8
Sphingomonas spp., 17
square-wave pulses, 116–17, *118*
Staphylococcus spp., 189, 224
Staphylococcus aureus, 119, **121**, 122, 124, 157, 197, **215**, **219–20**, 222, **283**, 312
Staphylococcus saprophyticus, **216**
starch, 225
Streptococcus lactis, **121**
Streptococcus pyogenes, 312
Streptococcus spp., 224
Streptococcus thermophilus, **57**, 234, 269, 275, 312
structure/function claims, 310–11
sugar, 226
sugar syrup, 199
supercritical carbon dioxide, 206–7, 211, 235
SurePure tubular UV module, 186–7, 186, 191
surface disinfection, 192
Taylor–Couette reactor, 186, *186*
Tetra Pak Ultima process, 16
thermal processing, 33–4, **34**
 bacteriocins and, 279–80, 281–5
 canned milk sterilization, **34**
 evaporation and concentration, **34**
 heat treatment for yoghurt, **35**
 heating before powder production, **35**
 microbial inactivation, 55–60, **57**
 cold spot identification, 56–7
 microwave heating *see* microwave heating
 microwave heating, 42–54
 ohmic heating *see* ohmic heating
 preheating, **34**
 radiofrequency heating *see* radiofrequency heating
 spray dryer heating, **35**
 thermization, **34**
 ultra high temperature, **34**
thermosonation, 125
 microbial inactivation, 156–7
thiamin, 316
thiols, 54
trans fatty acids, 52
transglutaminase, 83
transmembrane permeation (TMP), 2
triglycerides, 235
Trojan UV Technologies Inc, 186
turbidity, 182
turbulent flow, 96, 185
ultra high temperature (UHT) milk, 15, 129
ultrafiltration (UF), 1, **3**
 film theory model, 10
 ultrasound-assisted, 157–9
ultrapasteurized milk, 15
ultrasound, 149–50
 airborne sonication, 151
 applications, 150
 casein micelle, 163–4
 creaming, 155
 degassing and foam reduction, 155–6
 direct contact sonication, 151
 effect on sensory characteristics, 172–3
 enzymes, 157
 equipment, 151
 filtration, 157–9
 homogenization, 152–5
 lactose sonocrystallization, 159–61
 microbial inactivation, 156–7

- milk concentrate viscosity, 164–7
- powder rehydration, 161–2
- whey proteins
 - chemical effects, 169
 - heat stability, 169–72
 - rheological properties, 168–9
- ultraviolet (UV) treatment, 181–2
 - absorption coefficient, **184**
 - advantages, 182
 - applications, 183
 - commercial developments, 192–4
 - dose determination, 187
 - issues, 183
 - microbial inactivation, 182, **193**
 - mechanisms of action, 188–9
 - packaging and surface disinfection, 192
 - process overview, 183–5
 - pulsed light *see* pulsed light technology
 - pulsed light, 194, 196–9
 - advantages, 194
 - commercial developments, 199
 - principles of operation, 195
 - treatment systems, 184–5
 - coiled tube reactors, 185, 190
 - water, 194
 - uniform transmembrane pressure (UTP), 5, 13
 - US Department of Agriculture (USDA), 308
 - vaccenic acid, 319
 - vegetables, **73**
 - viscosity control, 164–6
 - viscosity, 226, 8
 - vitamins, 128, 136, 229–30, **261, 315**, 231
 - fat-soluble, 314–16
 - K, 316
 - water-soluble, 316–17
 - volume concentration reduction (VCR), 7
 - water, 41
 - dipole rotation, 43
 - Wek-Tek, 194
 - Westfalia Separator Group, 15–16
 - whey proteins
 - carbon dioxide treatment and, 225
 - fractionation, 237–9
 - concentrate (WPC), 162
 - high-pressure
 - homogenization, 100–1, 102
 - high-pressure treatment, 75–6
 - isolate (WPI), 235
 - microwave heating, 52–3
 - pulsed light treatment, 198–9
 - sonication
 - chemical effects, 169
 - gelation and viscosity, 167–8
 - heat stability, 169–72
 - whey solutions
 - concentration, 2, 13–14
 - gel formation ability, 51
 - heating, **41**
 - Yersinia enterocolitica*, **216**, 228
 - yoghurt
 - beverages, 138
 - carbon dioxide, 233
 - high-pressure homogenization, 104–5
 - high-pressure processing, 83
 - pulsed electric field, 138
 - thermal processing, **35**
 - zinc, 318
 - Zygosaccharomyces bailii*, **216**

Food Science and Technology Books

WILEY Blackwell

GENERAL FOOD SCIENCE & TECHNOLOGY, ENGINEERING AND PROCESSING

Food Texture Design and Optimization	Dar	9780470672426
Nano- and Microencapsulation for Foods	Kwak	9781118292334
Extrusion Processing Technology: Food and Non-Food Biomaterials	Bouvier	9781444338119
Food Processing: Principles and Applications, 2nd Edition	Clark	9780470671146
The Extra-Virgin Olive Oil Handbook	Peri	9781118460450
Mathematical and Statistical Methods in Food Science and Technology	Granato	9781118433683
The Chemistry of Food	Velisek	9781118383841
Dates: Postharvest Science, Processing Technology and Health Benefits	Siddiq	9781118292372
Resistant Starch: Sources, Applications and Health Benefits	Shi	9780813809519
Statistical Methods for Food Science: Introductory 2nd Edition	Bower	9781118541647
Formulation Engineering of Foods	Norton	9780470672907
Practical Ethics for Food Professionals: Research, Education and the Workplace	Clark	9780470673430
Edible Oil Processing, 2nd Edition	Hamm	9781444336849
Bio-Nanotechnology: A Revolution in Food, Biomedical and Health Sciences	Bagchi	9780470670378
Dry Beans and Pulses: Production, Processing and Nutrition	Siddiq	9780813823874
Genetically Modified and non-Genetically Modified Food Supply Chains: Co-Existence and Traceability	Bertheau	9781444337785
Food Materials Science and Engineering	Bhandari	9781405199223
Handbook of Fruits and Fruit Processing, second edition	Sinha	9780813808949
Tropical and Subtropical Fruits: Postharvest Physiology, Processing and Packaging	Siddiq	9780813811420
Food Biochemistry and Food Processing, 2nd Edition	Simpson	9780813808741
Dense Phase Carbon Dioxide	Balaban	9780813806495
Nanotechnology Research Methods for Food and Bioproducts	Padua	9780813817316
Handbook of Food Process Design, 2 Volume Set	Ahmed	9781444330113
Ozone in Food Processing	O'Donnell	9781444334425
Food Oral Processing	Chen	9781444330120
Food Carbohydrate Chemistry	Wrolstad	9780813826653
Organic Production & Food Quality	Blair	9780813812175
Handbook of Vegetables and Vegetable Processing	Sinha	9780813815411

FUNCTIONAL FOODS, NUTRACEUTICALS & HEALTH

Antioxidants and Functional Components in Aquatic Foods	Kristinsson	9780813813677
Food Oligosaccharides: Production, Analysis and Bioactivity	Moreno-Fuentes	9781118426494
Novel Plant Bioresources: Applications in Food, Medicine and Cosmetics	Gurib-Fakim	9781118460610
Functional Foods and Dietary Supplements: Processing Effects and Health Benefits	Noomhorm	9781118227879
Food Allergen Testing: Molecular, Immunochemical and Chromatographic Techniques	Siragakis	9781118519202
Bioactive Compounds from Marine Foods: Plant and Animal Sources	Hernández-Ledesma	9781118412848
Bioactives in Fruit: Health Benefits and Functional Foods	Skinner	9780470674970
Marine Proteins and Peptides: Biological Activities and Applications	Kim	9781118375068
Dried Fruits: Phytochemicals and Health Effects	Alasalvar	9780813811734
Handbook of Plant Food Phytochemicals	Tiwari	9781444338102
Analysis of Antioxidant-Rich Phytochemicals	Xu	9780813823911
Phytonutrients	Salter	9781405131513
Coffee: Emerging Health Effects and Disease Prevention	Chu	9780470958780
Functional Foods, Nutraceuticals & Disease Prevention	Paliyath	9780813824536
Nondigestible Carbohydrates and Digestive Health	Paeschke	9780813817620
Bioactive Proteins and Peptides as Functional Foods and Nutraceuticals	Mine	9780813813110
Probiotics and Health Claims	Kneifel	9781405194914
Functional Food Product Development	Smith	9781405178761

INGREDIENTS

Fats in Food Technology, 2nd Edition	Rajah	9781405195423
Processing and Nutrition of Fats and Oils	Hernandez	9780813827674
Stevioside: Technology, Applications and Health	De	9781118350669
The Chemistry of Food Additives and Preservatives	Msagati	9781118274149
Sweeteners and Sugar Alternatives in Food Technology, 2nd Edition	O'Donnell	9780470659687
Hydrocolloids in Food Processing	Laaman	9780813820767
Natural Food Flavors and Colorants	Attokaran	9780813821108
Handbook of Vanilla Science and Technology	Havkin-Frenkel	9781405193252
Enzymes in Food Technology, 2nd edition	Whitehurst	9781405183666
Food Stabilisers, Thickeners and Gelling Agents	Imeson	9781405132671
Glucose Syrups - Technology and Applications	Hull	9781405175562
Dictionary of Flavors, 2nd edition	DeRovira	9780813821351

FOOD SAFETY, QUALITY AND MICROBIOLOGY

Practical Food Safety	Bhat	9781118474600
Food Chemical Hazard Detection	Wang	9781118488591
Food Safety for the 21st Century	Wallace	9781118897980
Guide to Foodborne Pathogens, 2nd Edition	Labbe	9780470671429
Improving Import Food Safety	Ellefson	9780813808772
Food Irradiation Research and Technology, 2nd Edition	Fan	9780813802091
Food Safety: The Science of Keeping Food Safe	Shaw	9781444337228

For further details and ordering information, please visit www.wiley.com/go/food

Food Science and Technology from Wiley Blackwell

Decontamination of Fresh and Minimally Processed Produce	Gomez-Lopez	9780813823843
Progress in Food Preservation	Bhat	9780470655856
Food Safety for the 21st Century: Managing HACCP and Food Safety throughout the Global Supply Chain	Wallace	9781405189118
The Microbiology of Safe Food, 2nd edition	Forsythe	9781405140058
SENSORY SCIENCE, CONSUMER RESEARCH & NEW PRODUCT DEVELOPMENT		
Olive Oil Sensory Science	Monteleone	9781118332528
Quantitative Sensory Analysis: Psychophysics, Models and Intelligent Design	Lawless	9780470673461
Product Innovation Toolbox: A Field Guide to Consumer Understanding and Research	Beckley	9780813823973
Sensory and Consumer Research in Food Product Design and Dev, 2nd Ed	Moskowitz	9780813813660
Sensory Evaluation: A Practical Handbook	Kemp	9781405162104
Statistical Methods for Food Science	Bower	9781405167642
Concept Research in Food Product Design and Development	Moskowitz	9780813824246
Sensory and Consumer Research in Food Product Design and Development	Moskowitz	9780813816326
FOOD INDUSTRY SUSTAINABILITY & WASTE MANAGEMENT		
Food and Agricultural Wastewater Utilization and Treatment, 2nd Edition	Liu	9781118353974
Sustainable Food Processing	Tiwari	9780470672235
Food and Industrial Bioproducts and Bioprocessing	Dunford	9780813821054
Handbook of Sustainability for the Food Sciences	Morawicki	9780813817354
Sustainability in the Food Industry	Baldwin	9780813808468
Lean Manufacturing in the Food Industry	Dudbridge	9780813810072
FOOD LAWS & REGULATIONS		
Guide to US Food Laws and Regulations, 2nd Edition	Curtis	9781118227787
Food and Drink - Good Manufacturing Practice: A Guide to its Responsible Management (GMP6), 6th Edition	Manning	9781118318201
The BRC Global Standard for Food Safety: A Guide to a Successful Audit, 2nd Edition	Kill	9780470670651
Food Labeling Compliance Review, 4th edition	Summers	9780813821818
DAIRY FOODS		
Lactic Acid Bacteria: Biodiversity and Taxonomy	Holzappel	9781444333831
From Milk By-Products to Milk Ingredients: Upgrading the Cycle	de Boer	9780470672228
Milk and Dairy Products as Functional Foods	Kanekanian	9781444336832
Milk and Dairy Products in Human Nutrition: Production, Composition and Health	Park	9780470674185
Manufacturing Yogurt and Fermented Milks, 2nd Edition	Chandan	9781119967088
Sustainable Dairy Production	de Jong	9780470655849
Advances in Dairy Ingredients	Smithers	9780813823959
Membrane Processing: Dairy and Beverage Applications	Tamime	9781444333374
Analytical Methods for Food and Dairy Powders	Schuck	9780470655986
Dairy Ingredients for Food Processing	Chandan	9780813817460
Processed Cheeses and Analogues	Tamime	9781405186421
Technology of Cheesemaking, 2nd edition	Law	9781405182980
SEAFOOD, MEAT AND POULTRY		
Seafood Processing: Technology, Quality and Safety	Boziaris	9781118346211
Should We Eat Meat? Evolution and Consequences of Modern Carnivory	Smil	9781118278727
Handbook of Meat, Poultry and Seafood Quality, second edition	Nollet	9780470958322
The Seafood Industry: Species, Products, Processing, and Safety , 2nd Edition	Granata	9780813802589
Organic Meat Production and Processing	Ricke	9780813821269
Handbook of Seafood Quality, Safety and Health Effects	Alasalvar	9781405180702
BAKERY & CEREALS		
Oats Nutrition and Technology	Chu	9781118354117
Cereals and Pulses: Nutraceutical Properties and Health Benefits	Yu	9780813818399
Whole Grains and Health	Marquart	9780813807775
Gluten-Free Food Science and Technology	Gallagher	9781405159159
Baked Products - Science, Technology and Practice	Cauvain	9781405127028
BEVERAGES & FERMENTED FOODS/BEVERAGES		
Encyclopedia of Brewing	Boulton	9781405167444
Sweet, Reinforced and Fortified Wines: Grape Biochemistry, Technology and Vinification	Mencarelli	9780470672242
Technology of Bottled Water, 3rd edition	Dege	9781405199322
Wine Flavour Chemistry, 2nd edition	Bakker	9781444330427
Wine Quality: Tasting and Selection	Grainger	9781405113663
PACKAGING		
Handbook of Paper and Paperboard Packaging Technology, 2nd Edition	Kirwan	9780470670668
Food and Beverage Packaging Technology, 2nd edition	Coles	9780813812748
Food and Package Engineering	Morris	9780813814797
Modified Atmosphere Packaging for Fresh-Cut Fruits and Vegetables	Brody	9780813812748

For further details and ordering information, please visit www.wiley.com/go/food

WILEY END USER LICENSE AGREEMENT

Go to www.wiley.com/go/eula to access Wiley's ebook EULA.